

**UtiliTrac**

# Operating Instructions



  
**SEWERIN**  
Technologies for leak detection.

## **Measurable success by Sewerin equipment**

---

Congratulations. You have chosen a quality instrument manufactured by Hermann Sewerin GmbH.

Our equipment will provide you with the highest standards of performance, safety and efficiency. They correspond with the national and international guide-lines.

Please read and understand the following operating instructions before using the equipment; they will help you to use the instrument quickly and competently. If you have any queries we are available to offer advice and assistance at any time.

Yours

### **Hermann Sewerin GmbH**

Robert-Bosch-Straße 3  
33334 Gütersloh, Germany  
Tel.: +49 5241 934-0  
Fax: +49 5241 934-444  
[www.sewerin.com](http://www.sewerin.com)  
[info@sewerin.com](mailto:info@sewerin.com)

### **SEWERIN SARL**

17, rue Ampère – BP 211  
67727 Hoerdt Cedex, France  
Tél. : +33 3 88 68 15 15  
Fax : +33 3 88 68 11 77  
[www.sewerin.fr](http://www.sewerin.fr)  
[sewerin@sewerin.fr](mailto:sewerin@sewerin.fr)

### **SEWERIN IBERIA S.L.**

Centro de Negocios "Eisenhower"  
Avenida Sur del Aeropuerto  
de Barajas 28, Of. 2.1 y 2.2  
28042 Madrid, España  
Tel.: +34 91 74807-57  
Fax: +34 91 74807-58  
[www.sewerin.es](http://www.sewerin.es)  
[info@sewerin.es](mailto:info@sewerin.es)

### **Sewerin Ltd**

Hertfordshire  
UK  
Phone: +44 1462-634363  
[www.sewerin.co.uk](http://www.sewerin.co.uk)  
[info@sewerin.co.uk](mailto:info@sewerin.co.uk)

### **Sewerin Sp.z o.o.**

ul. Twórcza 79L/1  
03-289 Warszawa, Polska  
Tel.: +48 22 675 09 69  
Faks: +48 22 486 93 44  
Tel. kom. +48 501 879 444  
[www.sewerin.pl](http://www.sewerin.pl)  
[info@sewerin.pl](mailto:info@sewerin.pl)

## Receiver illustrated

---

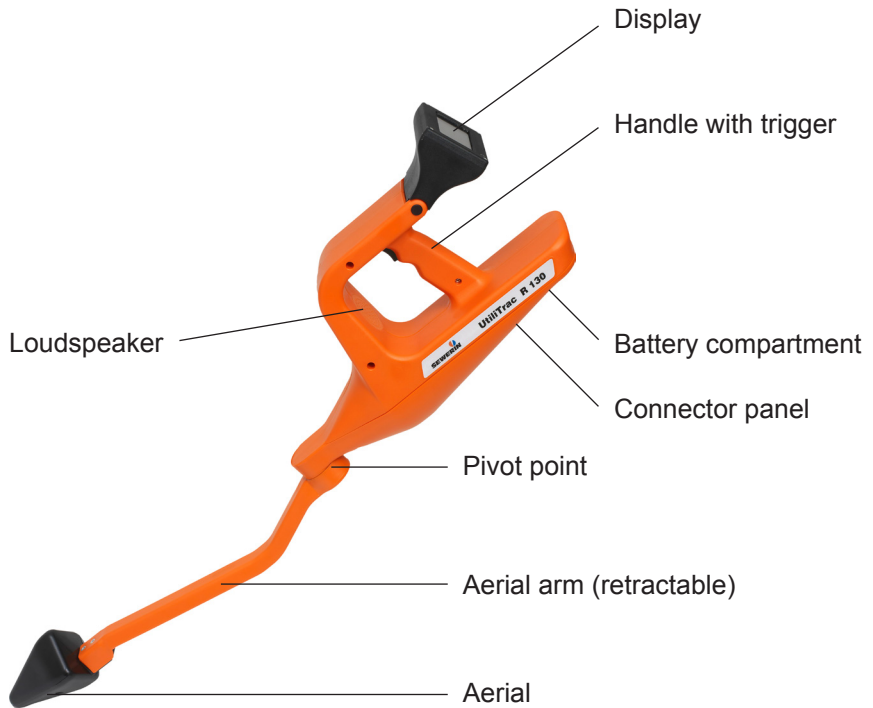
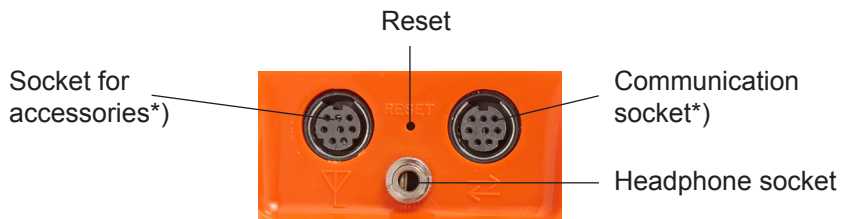

Fig. 1: Overview of receiver



\*) Socket is not configured and, therefore, must not be used by the user.

Fig. 2: Receiver connector panel

---

## G 100 generator illustrated

---

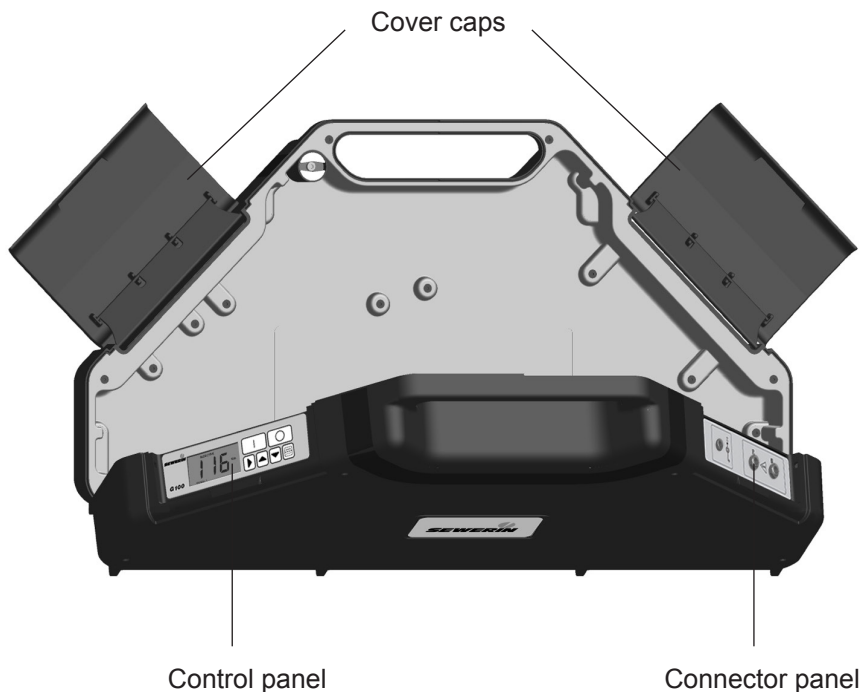

The battery compartment (not visible) is only accessible when the case is open.

Fig. 3: Overview of **G 100 generator**

**Operating Instructions**

# **UtiliTrac**

20.04.2016 a – V1.4.0 – 105896 – en

---



**WARNING! Risk of personal injury!**

This symbol is followed by safety instructions which must be observed to avoid personal injury!



**CAUTION! Risk of material damage!**

This symbol is followed by safety instructions which must be observed to avoid material damage!



**Note:**

This symbol is followed by additional information beyond the scope of product operation.

<b>1</b>	<b>Introduction .....</b>	<b>1</b>
1.1	Warranty .....	1
1.2	Purpose .....	2
1.3	Components of UtiliTrac.....	2
1.4	Intended use .....	2
1.5	General safety information .....	3
<b>2</b>	<b>Receiver .....</b>	<b>4</b>
2.1	General .....	4
2.2	Description .....	4
2.2.1	Trigger .....	5
2.2.2	Connector panel.....	6
2.3	Display .....	7
2.3.1	Display for LINE and SONDE .....	7
2.3.2	Display for LINE (Peak +) and SONDE (Peak +).....	8
2.3.3	Display for MAX CAMERA .....	9
2.3.4	Display for PEAK and NULL.....	10
2.3.5	Explanation of selected elements .....	11
2.3.5.1	Crosshairs/centring circle.....	11
2.3.5.2	ANR value (absolute field strength) .....	11
2.3.5.3	Signal display (relative field strength) .....	12
2.3.5.4	Battery symbol .....	12
2.3.5.5	Inductor symbol.....	13
2.3.5.6	Instruction field .....	13
2.3.5.7	Information field.....	14
2.3.5.8	Time symbol.....	15
2.3.6	Information on the depth and its accuracy .....	15
2.4	Frequencies .....	17
2.4.1	Frequency selection BY SCAN .....	17
2.4.2	Frequency selection from CATALOG .....	18
2.4.3	Favorites .....	18
2.5	Power supply.....	20
2.6	Operation .....	20
2.6.1	Extend aerial .....	20
2.6.2	Switching on the receiver .....	21
2.6.3	Switching off the receiver .....	22
2.6.4	Settings menu .....	23
2.6.4.1	Selecting Frequency, Locating mode, General .....	24
2.6.4.2	Adjusting the volume, contrast, backlight threshold .....	25

---

<b>3</b>	<b>G 100 generator</b> .....	<b>26</b>
3.1	General .....	26
3.2	Description of device .....	26
3.2.1	Control panel.....	27
3.2.2	Connector panel.....	28
3.2.3	G 100 modes.....	29
3.2.3.1	Frequencies .....	29
3.2.3.2	Power output.....	29
3.2.3.3	Current .....	30
3.3	Power supply.....	30
3.3.1	Internal power supply .....	30
3.3.1.1	Rechargeable battery.....	30
3.3.1.2	Disposable batteries.....	31
3.3.2	External power supply.....	32
3.4	Operation .....	32
3.4.1	Switching on the G 100.....	32
3.4.2	Switching mode.....	33
3.4.3	Setting the frequency .....	33
3.4.4	Setting the power output .....	33
3.4.5	Pulsate output signal (pulse function) .....	34
<b>4</b>	<b>Pipeline location</b> .....	<b>35</b>
4.1	General .....	35
4.2	Energize line .....	35
4.2.1	Direct energizing .....	36
4.2.2	Inductive energizing .....	37
4.3	Locating the line .....	38
4.4	Sources of error .....	38
<b>5</b>	<b>Location using sondes</b> .....	<b>39</b>
5.1	General .....	39
5.2	Locating the sonde.....	39
5.3	Note on the representation of the sonde .....	40
5.4	Sources of error .....	41
<b>6</b>	<b>Locating modes</b> .....	<b>42</b>
6.1	Overview .....	42
6.2	Signal curve .....	43

---



---

6.3	Locating in LINE mode .....	44
6.4	Locating in SONDE mode .....	46
6.5	Locating in LINE (Peak +) mode .....	47
6.6	Locating in SONDE (Peak +) mode .....	50
6.7	Locating in MAX CAMERA mode .....	53
6.8	Locating in PEAK mode .....	56
6.9	Locating in NULL mode .....	58
<b>7</b>	<b>Troubleshooting .....</b>	<b>60</b>
7.1	Problems with the receiver .....	60
7.1.1	General problems .....	60
7.1.2	Errors with BY SCAN frequency selection .....	61
7.2	Problems with the G 100 .....	62
<b>8</b>	<b>Appendix .....</b>	<b>63</b>
8.1	Specifications and permitted operating conditions .....	63
8.1.1	Receiver .....	63
8.1.2	G 100 generator .....	63
8.2	Available frequencies .....	64
8.2.1	Receiver .....	64
8.2.1.1	Active frequencies .....	64
8.2.1.2	Passive frequencies .....	65
8.2.2	G 100 generator .....	66
8.3	Accessories .....	67
8.4	EU declaration of conformity .....	71
8.5	Advice on disposal .....	71
8.6	Terminology and abbreviations .....	72
<b>9</b>	<b>Index .....</b>	<b>73</b>

# 1 Introduction

## 1.1 Warranty

The following instructions must be complied with in order for any warranty to be applicable regarding functionality and safe operation of this equipment.

Hermann Sewerin GmbH accepts no liability for any damages resulting from non-compliance with these instructions. The warranty and liability provisions of the terms of sale and delivery of Hermann Sewerin GmbH are not affected by the information given below.

- Do not operate this product until you have read and understood the relevant operating instructions.
- The product must only be operated by qualified specialist technicians.
- The product must only be used for its intended purpose.
- Repairs must only be carried out by a specialist technician or by other suitably trained personnel.
- Changes or modifications to this product must not be carried out without approval from Hermann Sewerin GmbH. The manufacturer cannot be held responsible for damages if unapproved modifications have been made.
- Only accessories supplied by Hermann Sewerin GmbH may be used with this product.
- All repairs must be carried out using replacement parts that have been approved by Hermann Sewerin GmbH.
- Only use the appropriate type of disposable/rechargeable battery.
- The manufacturer reserves the right to make technical modifications in the course of further development.

Generally applicable safety and accident prevention regulations must be complied with, in addition to the information provided in this manual.

### 1.2 Purpose

**UtiliTrac** is an electronic locating system for detecting electro-conductive lines/sondes in non-metal lines.

The **UtiliTrac** can be used for:

- Locating and tracking lines
- Determining the depth of a line/sonde

Location can be carried out passively or actively. For active location the required electromagnetic field is generated using the **G 100** generator or a sonde. Passive location makes use of the existing electromagnetic fields.

As with other systems, it is always recommended to check the plausibility of the result of the **UtiliTrac** locating process.

### 1.3 Components of UtiliTrac

**UtiliTrac** includes a receiver (**R 120** or **R 130**) and the **G 100** generator. **UtiliTrac R 110** is ideal for locating sondes in non-metal pipes. It therefore comes without a generator.

The receiver and **G 100** are described in detail in section 2/ section 3. There are various optional accessories available for **UtiliTrac** (see section 8.3).

### 1.4 Intended use

**UtiliTrac** is intended for professional industrial and commercial use. The appropriate specialist knowledge is required to operate the device.



**Note:**

If necessary, learn more about pipeline location theory before commencing practical work with **UtiliTrac**.

The system must only be used for the applications specified in section 1.2.

## 1.5 General safety information

The operating instructions must be read carefully and in their entirety. All advice given in these operating instructions must be followed.



### **WARNING!**

All applicable accident prevention regulations must be observed.

- Handle the devices with care. Set the devices down with care. Do not drop the devices.
- Do not place the devices in places where they are at risk of falling.
- Ensure that no dirt or moisture gets into the connections on the devices (sockets, reset).
- Do not put the devices away when they are wet or damp. If necessary, dry the devices after use.
- Observe the temperature ranges in which the devices may be used and stored (see section 8.1).

### **Receiver**

- Avoid impact to the receiver.
- Keep the receiver in its case when not in use.

### **G 100**

- Always adequately secure the setup location of the **G 100** to prevent injury to persons and damage to vehicles.
- Always place the **G 100** in a stable position.
- Close the cover caps of the **G 100** when not in use.

## 2 Receiver

### 2.1 General

The receiver can receive signals from electromagnetic fields (e.g. from an energized line, sonde). It interprets these signals and illustrates the result of this interpretation on its display, thus directing the user towards a location object.

The receiver is available in three models:

- **R 110** for locating sondes
- **R 120** for locating pipelines
- **R 130** for locating sondes and pipelines

### 2.2 Description

You will find an overview with the names of the receiver parts inside the front cover (fig. 1).

The receiver has an automatic gain control. During the locating process it adjusts to the maximum sensitivity when searching and the optimum sensitivity when determining the exact location.

The receiver features two sets of three inductors which are each arranged three-dimensionally. Three inductors are located in the aerial; the other three are above the pivot point.

The **volume** of the loudspeaker/headphones can be adjusted (see section 2.6.4.2). The volume does not affect the sensitivity of the device, i.e. loud signals are not necessarily strong signals.

The elements that appear on the **display** depend on the selected locating mode. For more detailed information please see section 2.3.

### 2.2.1 Trigger

The receiver can only be operated by the trigger.

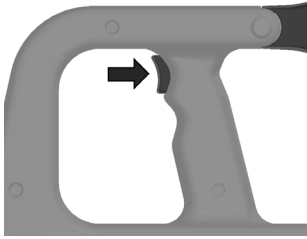

Fig. 4: Trigger on receiver

Two operations can be performed using the trigger.

Action		Function
<b>Click</b>	Press trigger briefly and release immediately	<ul style="list-style-type: none"><li>• Switch device on</li><li>• Switch device off</li><li>• Change menu option (select function or parameter)</li></ul>
<b>Press</b>	Press and hold the trigger	<ul style="list-style-type: none"><li>• Open or apply menu item</li><li>• Open settings menu</li></ul>

### 2.2.2 Connector panel

You will find an overview with the names of the connector panel parts inside the front cover (fig. 2).



**Note:**

The sockets must be covered using the corresponding protective caps when not in use.

### Headphone socket

This socket is intended for connecting headphones.

As soon as headphones are connected to the receiver, the device's loudspeaker will switch off.

### Reset

The reset function restarts the firmware on the receiver without affecting the settings.

To restart the firmware, insert a long, narrow object (e.g. wire of a bent paperclip) into the hole marked **RESET**.



**Note:**

Another way of restarting the firmware is to briefly remove the batteries from the battery compartment.

### Socket for accessories and communication socket



**WARNING!**

The sockets are not currently configured and, therefore, must not be used by the user.

## 2.3 Display

### 2.3.1 Display for LINE and SONDE

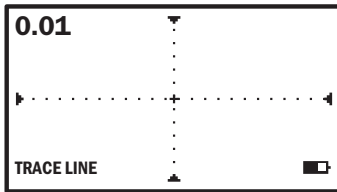
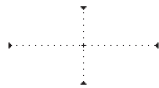

Fig. 5:  
Receiver display - locating in **LINE**  
and **SONDE** modes

When locating in **LINE** and **SONDE** modes the display features the following basic elements:

**0.01**

ANR value



Crosshairs

**TRACE LINE**

Locating mode/frequency

**~83 kHz** 



Battery symbol

In certain situations the message **INTERFERENCE** will appear in the information field.



### 2.3.2 Display for LINE (Peak +) and SONDE (Peak +)

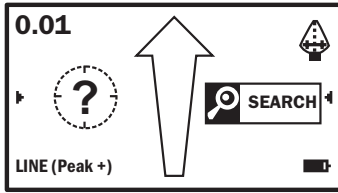







Fig. 6:  
Receiver display - locating  
in **LINE (Peak +)** and  
**SONDE (Peak +)** mode

When locating in **LINE (Peak +)** and **SONDE (Peak +)** modes the display features the following basic elements:

- |                                                                                                                    |                         |
|--------------------------------------------------------------------------------------------------------------------|-------------------------|
| <b>0.01</b>                                                                                                        | ANR value               |
|                                   | Inductor symbol         |
|                                   | Centring circle         |
|                                   | Signal display          |
|                                   | Instruction field       |
| <b>SONDE (Peak +)</b><br>~83 kHz  | Locating mode/frequency |
|                                 | Battery symbol          |

In certain situations the message **PEAK** will appear in the information field.

### 2.3.3 Display for MAX CAMERA

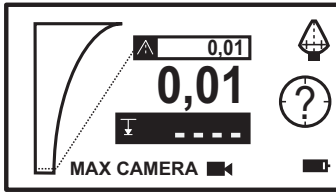

Fig. 7:  
Receiver display - locating in  
**MAX CAMERA** mode

When locating in **MAX CAMERA** mode the display features the following basic elements:

**0,01**

Current ANR value



Maximum ANR value



Inductor symbol



Centring circle



Signal display with slider



Depth

MAX CAMERA 

Locating mode/frequency

640 HZ 

Battery symbol



### 2.3.4 Display for PEAK and NULL

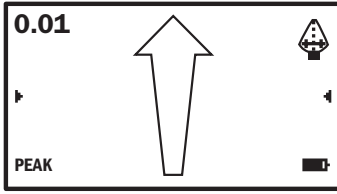

Fig. 8:  
Receiver display - locating in  
**PEAK** and **NULL** modes

When locating in **PEAK** and **NULL** modes the display features the following basic elements:

**0.01**

ANR value



Inductor symbol



Signal display

**PEAK**

Locating mode/frequency

~83 kHz 



Battery symbol

### 2.3.5 Explanation of selected elements

The main elements of the display are explained below. Other symbols or information may appear during the locating process. For the most part these are self-explanatory.

#### 2.3.5.1 Crosshairs/centring circle

The crosshairs (fig. 5)/centring circle (fig. 6) allow you to precisely align the receiver during the locating process. As a result of the locating process the location object must be directly below the centre of the crosshairs/centring circle.

#### 2.3.5.2 ANR value (absolute field strength)

The ANR value (fig. 5 to 8) indicates the absolute field strength of the received signal.

ANR value	Signal quality
> 5	Good
1 – 5	Adequate
< 1	Weak

The ANR value can range between 0 and 15,000. If the ANR value is very high you may need to reduce the output of the generator.

### 2.3.5.3 Signal display (relative field strength)

The signal display (fig. 6 to 8) illustrates the relative field strength. The fill level of the signal display represents the strength of the signal received and the sensitivity. The sensitivity is specified by the receiver using the automatic gain control.

#### Strength of signal received

Minimum      Average      Maximum

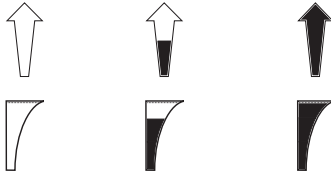



**Note:**

There may be maximum signal reception even if the signal display is not fully black.

### 2.3.5.4 Battery symbol

The battery symbol (fig. 5 to 8) provides information about the state of the batteries.

-  Full battery capacity
-  Reduced battery capacity
-  Battery dead > new batteries required

### 2.3.5.5 Inductor symbol

The inductor symbol (figs. 6 to 8) shows which inductors the receiver is using to receive a signal during the locating process.



**PEAK, LINE (Peak +), SONDE (Peak +),  
MAX CAMERA** locating modes



**NULL** locating mode

### 2.3.5.6 Instruction field

An instruction field is displayed during the locating process when using **LINE (Peak +)** and **SONDE (Peak +)** locating modes. It tells the user what to do next. The depth is shown in the instruction field at the end of a successful location.

Instruction	Description
<b>SEARCH</b>	<ul style="list-style-type: none"> <li>Receiver is out of range</li> <li>Search for range</li> </ul>
<b>MOVE RIGHT</b>	<ul style="list-style-type: none"> <li>Direction in which to move from current position.</li> </ul>
<b>MOVE LEFT</b>	
<b>MOVE AHEAD</b>	
<b>MOVE BACK</b>	
<b>ALIGN</b>	<ul style="list-style-type: none"> <li>Receiver is close to location object</li> <li>Receiver needs to be rotated on its longitudinal axis to obtain optimal alignment (fig. 41 and 46)</li> </ul>
<b>DEPTH</b>	<ul style="list-style-type: none"> <li>Depth of location object</li> </ul>

### 2.3.5.7 Information field

An information field may appear in certain situations.



Fig. 9:  
Receiver display – information field

Information	Description
<b>PEAK</b>	<ul style="list-style-type: none"><li>● Receiver is within the maximum signal range</li><li>● Location object just has to be precisely pinpointed</li><li>● Refers to <b>LINE (Peak +)</b> and <b>SONDE (Peak +)</b> locating modes</li></ul>
<b>INTERFERENCE</b>	<ul style="list-style-type: none"><li>● Explained below</li><li>● Refers to <b>LINE</b> and <b>SONDE</b> locating modes</li></ul>
<b>DETECTED:</b>	<ul style="list-style-type: none"><li>● Shows the output signal frequency determined <b>BY SCAN</b></li><li>● Regardless of locating mode</li></ul>

### INTERFERENCE

**INTERFERENCE** appears when the field strength in the inductors above the pivot point is greater than the field strength in the inductors in the aerial. This may be the case in the following situations:

- The location object is actually above the receiver.  
Example: If, when detecting lines indoors, the pipe is in the ceiling as opposed to the floor. In such cases you will need to hold the receiver up with the aerial.
- Several electromagnetic fields overlap.  
It may help to change the locating mode.
- Signal reception is too weak.  
Increasing the output of the generator may help.

### 2.3.5.8 Time symbol



Fig. 10:  
Receiver display – time symbol

The time symbol shows how much time is left before a visible menu disappears again unless the receiver is used in the meantime.

### 2.3.6 Information on the depth and its accuracy



Fig. 11:  
Receiver display – depth

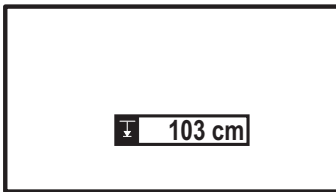

Fig. 12:  
Receiver display – depth  
(**MAX CAMERA** locating mode)



When working in **LINE**, **SONDE**, **LINE (Peak +)**, **SONDE (Peak +)** and **MAX CAMERA** locating modes, the depth of the location object is shown if the receiver is directly above the location object.

The depth can be displayed in various units. The relevant unit can be selected in the settings menu under **GENERAL**.

Please note before any excavation that the calculated depth always refers to the centre of the electromagnetic field. The top edge of large pipelines, therefore, may not be as deep as specified.

### Accuracy of the specified depth



Fig. 13:  
Receiver display – accuracy of specified depth

When using **LINE** and **SONDE** locating modes the accuracy (quality) of the value displayed for the depth is estimated by the device and shown directly below the depth.

The accuracy depends on various factors. For example, the shape of the electromagnetic field affects the accuracy. Round fields provide high accuracy, elliptic fields reduce the accuracy.

#### As a rule of thumb:

- **low figure for the accuracy > depth calculated highly accurate**
- **high figure for the accuracy > depth calculated not very accurate**



#### **Note:**

The accuracy does not indicate the absolute or relative depth error.

## 2.4 Frequencies

The receiver can work on various frequencies. The receiver must always be on the same frequency as the transmitter (**G 100**, sonde/passive source).

There are two ways of adjusting the frequency on the receiver.

1. The transmitter frequency is unknown. The receiver determines the frequency **BY SCAN**.
2. The transmitter frequency is known. The user selects the frequency from a **CATALOG**.

An overview of the available frequencies can be found in section 8.2.

### 2.4.1 Frequency selection BY SCAN

The receiver can only scan for available frequencies.

If the frequency is being determined **BY SCAN**, the **SCANNING** message will always appear on the display. However, the receiver has only been able to determine a frequency if **DETECTED: ...** then appears in the information field.

Following a successful scan the **DO WHAT?** menu will appear.

- **SELECT** applies the determined value to the locating process.
- **ADD TO FAVORITES?** applies the determined value to the locating process and saves it as a favorite.

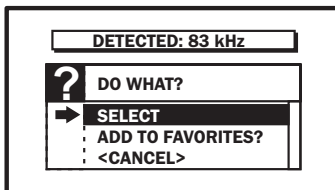

Fig. 14:  
Receiver display – following a successful scan DETECTED appears in the information field

### 2.4.2 Frequency selection from CATALOG

All the available frequencies can be selected from a **CATALOG**. The active frequencies are listed first, followed by the passive frequencies.

Frequency	Source of electromagnetic field
<b>ACTIVE (GENERATOR)</b>	<ul style="list-style-type: none"><li>● Generator</li><li>● Sonde</li></ul>
<b>PASSIVE</b>	<ul style="list-style-type: none"><li>● Power lines (50 Hz)</li><li>● Frequency in VLF range</li><li>● CPS lines</li><li>● etc.</li></ul>

### 2.4.3 Favorites

Frequently used frequencies can be saved as favorites. Favorites are listed in the **SET FREQUENCY** menu. This is a short-cut way of selecting a frequency.

#### Save frequencies as favorites (SET FAVORITES)

The device is switched on.

1. Press the trigger. The settings menu (fig. 17) appears.
2. Click the trigger until the **SET FREQUENCY** menu is selected.  
The selected menu is inverted.
3. Press the trigger. The **SET FREQUENCY** menu opens.
4. Click the trigger until **SET FAVORITES** is selected.
5. Press the trigger. The **SET FAVORITES** menu opens.
6. Click the trigger until the relevant type of frequency (**ACTIVE (GENERATOR)** or **PASSIVE**) is selected.
7. Press the trigger. The available frequencies are listed in the **SET FAVORITES** menu.

A small square is visible in front of each frequency. A black square indicates that the respective frequency has been saved as a favorite. Frequencies with empty squares are not favorites.

Frequencies can be added to and removed from the favorites.

8. Click the trigger until the relevant frequency has been selected.
9. Press the trigger. A small menu will appear at the left-hand edge.
10. Click the trigger until the check (right-hand symbol) is selected.
11. Press the trigger. The selected frequency is added to/removed from the favorites.
12. Repeat steps 8 to 11 for other frequencies as necessary.
13. Click the trigger until **<EXIT>** is selected.
14. Likewise, close the next menu via **<EXIT>**. The device will continue locating.

### 2.5 Power supply

The receiver is powered by alkaline batteries (8x mignon/LR6/AA). Four batteries are stored in the battery compartment, another four are in the lid of the battery compartment.

An empty battery symbol indicates that the batteries need to be replaced (see section 2.3.4.4).

#### Battery change

The receiver is **switched off**.

1. Extend the aerial.
2. Open the battery compartment by first sliding the battery compartment lid slightly (away from the connector panel). Then take the battery compartment lid off by pulling it up at an angle.
3. Change the batteries. Ensure that the new batteries are inserted with the correct polarity.
4. Replace the battery compartment lid. You should hear it clicking into place.

### 2.6 Operation

#### 2.6.1 Extend aerial

The receiver is folded up for transportation. The aerial must be extended for work.

- Rotate the aerial arm 180° on its pivot point. At the end point the aerial arm will click into its final position.



**Note:**

The aerial can only be folded out in one direction. There is a locking pin on the other side.

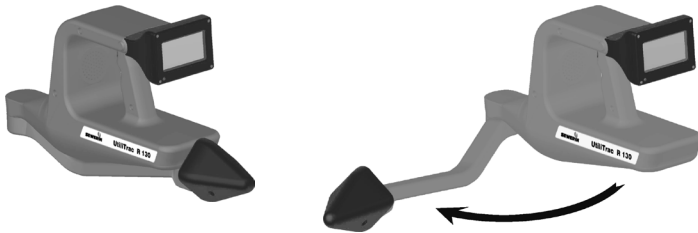

Fig. 15: Receiver folded (left) and extended (right)

### 2.6.2 Switching on the receiver

1. Click the trigger. The receiver switches on.

The Sewerin logo appears briefly on the display. The start menu then appears.

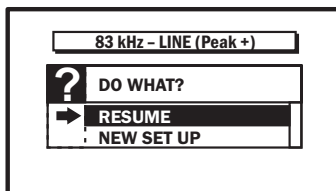

Fig. 16:  
Receiver display – start menu

The current device setting is displayed. (Example in fig. 16: frequency 83 kHz, **LINE (Peak +)** locating mode)

2. If you want to continue using the **current settings**:

Select **RESUME** from the **DO WHAT?** menu. The receiver is ready to locate. The frequency and locating mode can be changed at any time via the settings menu.

OR

If you want to work with **another frequency or locating mode**:

Select **NEW SET UP** from the **DO WHAT?** menu. The **SET FREQUENCY** menu will appear.

- Select the relevant frequency. The **LOCATING MODE** menu will appear.
- Select the relevant locating mode. The receiver is ready to locate.

### Select a passive frequency via **NEW SET UP**

Once a passive frequency has been selected via **NEW SET UP**, the receiver will automatically specify a locating mode for lines (**LINE**, **LINE (Peak +)**, **PEAK** or **NULL**). You can then change the locating mode via the settings menu.

### 2.6.3 Switching off the receiver

To switch off the receiver, click the trigger. If a menu is still open in the display, you must first close it before switching off the device.

The receiver switches off automatically if it has not been used for 10 minutes.







### 2.6.4 Settings menu

You can change the settings during the locating process via the settings menu.



Fig. 17: Receiver display - settings menu

The settings menu consists of six submenus.

Symbol	Menu	Function
	<b>SET FREQUENCY</b>	<ul style="list-style-type: none"> <li>• Set frequency</li> </ul>
	<b>SET LOCATING MODE</b>	<ul style="list-style-type: none"> <li>• Select locating mode</li> </ul>
	<b>VOLUME</b>	<ul style="list-style-type: none"> <li>• Adjust the volume of loud-speaker/headphones</li> </ul>
	<b>SET CONTRAST</b>	<ul style="list-style-type: none"> <li>• Adjust the contrast of the display</li> </ul>
	<b>BACKLIGHT THRESHOLD</b>	<ul style="list-style-type: none"> <li>• Adjust the threshold for automatic switch-on and switch-off of the display illumination</li> </ul>
	<b>GENERAL</b>	<ul style="list-style-type: none"> <li>• Select language and unit of length</li> <li>• Display information about the device (device information)</li> </ul>



### 2.6.4.1 Selecting Frequency, Locating mode, General

The device is switched on.

1. Press the trigger. The settings menu (fig. 17) appears.
2. Click the trigger until the relevant menu has been selected.  
The selected menu is inverted.
3. Press the trigger. The menu opens.
4. Click the trigger until the relevant item in the menu has been selected.

The selected menu item is inverted. In addition, a small arrow on the left-hand side points to the selected menu item.

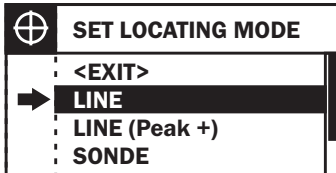

Fig. 18:  
**LOCATING MODE** menu

Select **<EXIT>** to close the menu without changing any settings.

5. Press the trigger. The selected setting will be applied. The device will continue locating.

### 2.6.4.2 Adjusting the volume, contrast, backlight threshold

The device is switched on.

1. Press the trigger. The settings menu (fig. 17) appears.
2. Click the trigger until the relevant menu has been selected.  
The selected menu is inverted.
3. Press the trigger. The menu opens.



Fig. 19:  
Adjustment bar in the  
**CONTRAST** menu

4. Decide whether you want to reduce or increase the value.  
Click the trigger until the relevant arrow symbol in the top right corner has been selected.  
The selected symbol is highlighted in black.

**Explanation:**

- Arrow to left: Value is reduced
  - Arrow to right: Value is increased
5. Press the trigger. The adjustment bar will change in the specified direction.
  6. Click the trigger until the cross (between the two arrows) in the top right corner has been selected.
  7. Press the trigger. The set value will be applied. The device will continue locating.

## 3 G 100 generator

### 3.1 General

The **G 100** generator can be used to energize lines both directly (galvanically) and inductively. The **G 100** is, therefore, also referred to as a transmitter.

There are various power outputs and frequencies available for energizing.

The **G 100** is integrated in the carrying case for the receiver.



**Note:**

The **G 100** is only designed for use with the **R 120** and **R 130** receivers.

### 3.2 Description of device

You will find an overview and all the part names of the **G 100** in the front cover (fig. 3).

The **cover flaps** are used to close the carrying case and also protect the control and connector panel when the **G 100** is not in use.

Either a special rechargeable battery or a battery case can be fitted in the **battery compartment**.

### 3.2.1 Control panel

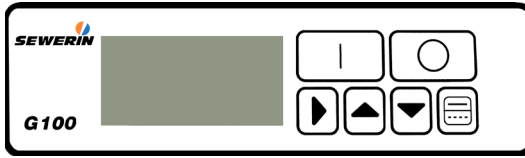

Fig. 20: G 100 control panel

The **display** shows the mode (see section 3.2.3) and the type of energizing. If no direct output socket is in use energizing will be carried out **INDUCTIVE**, otherwise it will take place **DIRECT**.

#### Description of keys

Symbol	Designation	Function
	<b>ON key</b>	<ul style="list-style-type: none"> <li>• Switch on G 100</li> </ul>
	<b>OFF key</b>	<ul style="list-style-type: none"> <li>• Switch off G 100</li> </ul>
	<b>SELECT key</b>	<ul style="list-style-type: none"> <li>• Select mode</li> </ul>
	<b>UP key</b>	<ul style="list-style-type: none"> <li>• Select next setting up</li> </ul>
	<b>DOWN key</b>	<ul style="list-style-type: none"> <li>• Select next setting down</li> </ul>
	<b>PULSE key</b>	<ul style="list-style-type: none"> <li>• Pulsate output signal (briefly press key)</li> <li>OR</li> <li>• Show battery charge (hold key down for at least 2 s)</li> </ul>

### 3.2.2 Connector panel

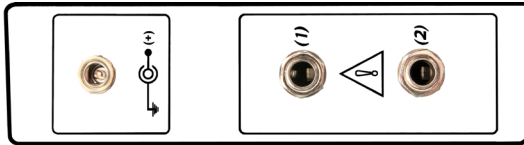

Fig. 21: **G 100** connector panel with socket for direct current power supply (left) and direct output sockets (1) and (2) (right)

#### Socket for direct current power supply

This socket is used to connect the **G 100** to the external power supply (see section 3.3.2).



**Note:**

The socket for the direct current power supply must not be used to charge the rechargeable battery.

#### Direct output sockets

These sockets are used to connect the **G 100 cable set** or the **AZ 135 cable clamp**.

The type of energizing is determined by the number of direct output sockets in use.

Plug in socket		G 100 energizes...	
(1)	(2)		
–	–	inductively	
×	–	directly	● with the set power output and frequency
–	×	directly	
×	×	directly	● set power output is divided over the two sockets

Direct energizing using both direct output sockets is only possible with two **G 100 cable sets**. A dedicated frequency must be set for each socket (signal).

### 3.2.3 G 100 modes

The **G 100** can display three different modes: frequency, power output, current. When the **G 100** is switched on, the first mode to appear is always the frequency.

#### 3.2.3.1 Frequencies

The line to be located is energized directly or inductively with the frequency set on the **G 100** (location frequency).



Fig. 22:  
G 100 display – frequency mode

The frequency setting is shown in **Hz** or **kHz**.

With **direct energizing** the display also shows which direct output socket is in use (**SIGNAL1** or **SIGNAL2**). If both direct output sockets are in use, the last socket to be connected is shown.

#### 3.2.3.2 Power output

The maximum electrical power emitted by the **G 100** (output power) depends on the selected frequency and the external resistance.

In power mode you can set what percentage of the output power should be emitted for energizing. This value can be 10 %, 25 %, 50 % or 100 %.

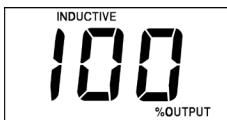

Fig. 23:  
G 100 display – power mode

The power setting is shown in **%OUTPUT**.

#### 3.2.3.3 Current

The current depends on the frequency and power settings. It also indicates the magnitude of the external resistance.



Fig. 24:  
G 100 display – current mode

The current is shown in **mA**.

### 3.3 Power supply

The **G 100** can be powered either internally or externally.

#### 3.3.1 Internal power supply

The device is powered internally by a special lithium-ion rechargeable battery as standard. Disposable batteries can also be used.

##### 3.3.1.1 Rechargeable battery

Detailed information about the rechargeable battery can be found in separate operating instructions.

#### Inserting and connecting the rechargeable battery

1. Insert the plug of the cable in the battery compartment into the power connector on the battery case.



Fig. 25: Battery compartment for the **G 100** with connector cable

2. Place the rechargeable battery in the battery compartment.
3. Tighten the thumb screws.

### 3.3.1.2 Disposable batteries

If you wish to use disposable batteries to power the **G 100** (8x baby/LR14/C), these must be placed in a battery case. Use the adapter cable provided to connect the battery case in the **G 100**.

#### Checking the charge

- Hold the PULSE key down for at least 2 s.

Whilst the PULSE key is held down the display alternates between **bAt** and a number between 0 and 100.

The number represents the battery charge. The bigger the number, the greater the remaining battery capacity.



#### Note:

Only the charge of disposable batteries can be checked using the PULSE key. If the **G 100** is powered by rechargeable battery, the displayed **bAt** value will always be **100**. The LED on the rechargeable battery indicates its charge.

#### Changing the batteries

When the batteries need changing, **bAt** flashes on the display.

The **G 100** is **switched off**.

1. Undo the thumb screws.
2. Remove the battery compartment lid.
3. Remove the battery case from the battery compartment. Disconnect the plug (battery compartment) from the connecting socket (adapter cable).
4. Change the batteries. Ensure that the new batteries are inserted with the correct polarity.
5. Reconnect the plug (battery compartment) to the connecting socket (adapter cable).



6. Place the battery case into the battery compartment. The battery case must not lie on top of the cable.
7. Replace the battery compartment lid.
8. Tighten the thumb screws.

#### 3.3.2 External power supply

The **G 100** can be powered externally using the **G 100 AC/DC adapter** or the **G 100 vehicle cable**. These are connected at the direct current power supply socket on the connector panel (fig. 21).

### 3.4 Operation

#### 3.4.1 Switching on the G 100

1. Prepare the **G 100** for location according to the actual situation.

To directly energize a line:

Connect the **G 100 cable set** or the **AZ 135 cable clamp** to the direct output sockets (see section 3.2.2).

2. Press the ON key.

**On** will initially appear on the display. The current version of the firmware will then appear.

Once the frequency appears, the **G 100** is ready for operation (fig. 22).

#### Switching off the G 100

To switch off the **G 100**, press the OFF key.

### 3.4.2 Switching mode

The **G 100** is switched on.

- Press the SELECT key. The next mode will appear.

The selection does not need to be confirmed. The modes appear recurrently in the following order: frequency – power output – current.

### 3.4.3 Setting the frequency

There are several frequencies available for selection (see section 8.2.2).

The **G 100** is switched on. The device is in **frequency** mode.

- Select the relevant frequency using the UP/DOWN key.

The set value will be used by the **G 100**.



**Note:**

If both direct output sockets are used for direct energizing, the frequency must be set individually for each socket (signal).

### 3.4.4 Setting the power output

The **G 100** is switched on.

1. Select the **power output** mode using the SELECT key.
2. Select the relevant power output using the UP/DOWN key.

The set value will be used by the **G 100**.

#### 3.4.5 Pulsate output signal (pulse function)

The output signal of the **G 100** can be pulsated. This saves electricity.



**Note:**

The **G 100** offers a pulse function as standard. However, it is only suitable for use with the **R 120** and **R 130** receivers in certain circumstances.

If both direct output sockets are used for direct energizing, only the output signal of the socket shown on the display (**SIGNAL1** or **SIGNAL2**) can be pulsated.

#### Switching on the pulse function

1. Select the **frequency** mode using the SELECT key.
2. Briefly press the PULSE key. The output signal will pulsate. **INDUCTIVE** or **DIRECT** will flash on the display depending on the type of energizing.

#### Switching off the pulse function

- Press the PULSE key again briefly. The output signal will stop pulsating.

## 4 Pipeline location

### 4.1 General

Pipelines and cables can be located by detecting electromagnetic fields. These fields are generated by energizing the respective line. The **UtiliTrac** receiver reacts to electromagnetic fields along the piping.

One of the prerequisites for pipeline location is that the line is electroconductive. Lines that are not electroconductive must be located using sondes (see section 5).

The approximate location of the line must also be known.

The receiver cannot display bends and forks in the piping. As each individual locating process determines points along the line, determining several points can indicate the course of a line.

Carry out the following steps to locate a line:

1. Energize line
2. Locate line

### 4.2 Energize line

In order to be able to locate a line, it must carry a current with a certain frequency, so that an electromagnetic field is generated. To this end, the line is directly (galvanically) or inductively energized.

### 4.2.1 Direct energizing

Direct energizing involves supplying power from a generator to the line via a cable.

**This is only possible if** an electrical connection can be made at an open part of the line.



#### **WARNING!**

The terminals of the **G 100 cable set** must never be connected to live pipelines.

The **G 100** is **switched off**.

1. Plug the **G 100 cable set** into one of the direct output sockets of the **G 100**. Use direct output socket (1) or (2).
2. Connect one of the terminals to the open part of the line.
3. Firmly stick an earthing spike into the ground.
4. Connect the other terminal to the earthing spike.
5. Switch on the **G 100**.
6. Set a frequency.
7. Set the power output.

The line is energized with the selected frequency and power.

### 4.2.2 Inductive energizing

Inductive energizing involves positioning the generator above the line to be located. The electromagnetic field generated by the generator causes a current flow in the line to be located.

The **G 100** is **switched off**. There are **no cables in the direct output sockets** of the **G 100**.

1. Switch on the **G 100**.
2. Set a frequency.
3. Set the power output.
4. Close the cover caps on the case (**G 100**).
5. Position the case as parallel as possible above the line.
6. Rotate the **G 100** approx.  $15^\circ$  away from the assumed direction of the pipeline.

The line is energized with the selected frequency and power.

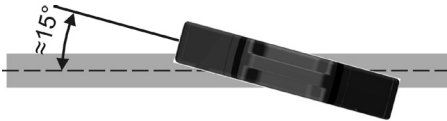

Fig. 26: Inductive energizing – **G 100** aligned above the line

### 4.3 Locating the line

The line is energized (see section 4.2).

1. Switch on the receiver.
2. Select a frequency for the receiver (see sections 2.4 and 2.6.4.1).



**Note:**

The receiver and transmitter (**G 100**) must be on the same frequency.

3. Select a suitable locating mode. **LINE**, **LINE (Peak +)**, **PEAK** and **NULL** are suitable modes.
4. Hold the receiver vertically downwards.
5. Locate the line. The locating process varies according to the selected locating mode. Detailed information about the locating modes can be found in section 6.

### 4.4 Sources of error

Interference fields are the most common sources of error. Interference fields can distort the electromagnetic fields along the line, thus producing erroneous location results. This can apply to both the position and the depth of the line.

Electromagnetic fields that are too weak or distorted can also lead to incorrect location results. Distorted fields occur, for example, when other lines cross the line to be located or at junctions and bends.

If there are lines close beside or below one another in parallel, the receiver will only be able to determine one line. The line determined is an imaginary line between those that are actually present.

## 5 Location using sondes

### 5.1 General

Lines that are not electroconductive can be located using sondes, which are placed in the line. When switched on, sondes generate an electromagnetic field which can be located by the **UtiliTrac** receiver.

Sondes come in different shapes and sizes. They can also be integrated in pipeline diagnostic cameras.

Follow the steps below to locate lines using sondes:

1. Switch on sonde
2. Tune the receiver and sonde into each other
3. Locate sonde

### 5.2 Locating the sonde

1. Switch on the sonde. Further information can be found in the sonde operating instructions.
2. Switch on the receiver.
3. Select a frequency for the receiver (see sections 2.4 and 2.6.4.1).

When using analogue sondes the frequency must be determined **BY SCAN**.



**Note:**

The receiver and sonde must be on the same frequency.

4. Select a suitable locating mode. **SONDE**, **SONDE (Peak +)**, **MAX CAMERA**, **PEAK** and **NULL** are suitable locating modes.
5. Check that the sonde is working and can be located by the receiver by performing a location test outside of the line.
6. Insert the sonde into the line to be located.



7. Hold the receiver vertically downwards and locate the sonde.

It is recommended to do this gradually. Push the sonde in slightly and locate it. Push the sonde in a bit further and locate it again. Keep doing this until the sonde is at its final position.

The locating process varies according to the selected locating mode. Detailed information about the locating modes can be found in section 6.

### 5.3 Note on the representation of the sonde

In **SONDE**, **SONDE (Peak +)** and **MAX CAMERA** locating modes the sonde is displayed as soon as the receiver is in the vicinity of the sonde (in range).

If the sonde is in a line parallel to the earth's surface, i.e. perpendicular to the receiver, the sonde will be represented as a rectangle. The receiver can determine the precise depth.

If the sonde is in a line which is not parallel to the earth's surface, the sonde will be represented as a cylinder. The receiver may not be able to determine the exact depth. In this case try holding the receiver at an angle so that the receiver and the sonde are at right angles to each other again.

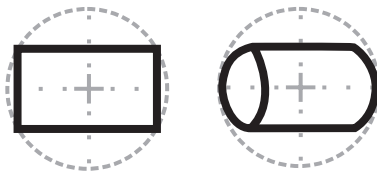

Fig. 27: Alignment of receiver to sonde: at right angles (left) / not at right angles (right)

### 5.4 Sources of error

Interference fields are the most common sources of error. Interference fields can distort the electromagnetic fields along the line, thus producing erroneous location results. This can apply to both the position and the depth of the sonde in the line.

Electromagnetic fields that are too weak or distorted can also lead to incorrect location results. Distorted fields occur, for example, when the sonde is close to a metal line.

## 6 Locating modes

### 6.1 Overview

Locating mode	Locating		Remark
	Line	Sonde	
<b>LINE</b>	×		<ul style="list-style-type: none"> <li>● for metal lines</li> <li>● developed user support</li> <li>● lower detection depth than with <b>LINE (Peak +)</b></li> <li>● depth display</li> </ul>
<b>SONDE</b>		×	<ul style="list-style-type: none"> <li>● for sondes e.g. in plastic piping</li> <li>● developed user support</li> <li>● lower detection depth than with <b>SONDE (Peak +)</b></li> <li>● depth display</li> <li>● not available for location with passive frequencies</li> </ul>
<b>LINE (Peak +)</b>	×		<ul style="list-style-type: none"> <li>● for locating lines where signal is weak</li> <li>● combination of <b>LINE</b> and <b>PEAK</b> modes</li> <li>● depth display</li> </ul>
<b>SONDE (Peak +)</b>		×	<ul style="list-style-type: none"> <li>● for locating lines where signal is weak</li> <li>● combination of <b>SONDE</b> and <b>PEAK</b> modes</li> <li>● depth display</li> <li>● not available for location with passive frequencies</li> </ul>
<b>PEAK</b>	×	×	<ul style="list-style-type: none"> <li>● for locating lines where signal is weak</li> <li>● considerable detection depth</li> </ul>
<b>NULL</b>	×	×	<ul style="list-style-type: none"> <li>● for locating lines in overlapping fields</li> </ul>
<b>MAX CAMERA</b>		×	<ul style="list-style-type: none"> <li>● for locating lines where signal is weak</li> <li>● depth display</li> </ul>

## 6.2 Signal curve

Successful location depends on knowing the signal curve close to the location object. The signal curve indicates where there is maximum/minimum signal reception inside the range (e.g. minimum directly above the location object).

The signal curve depends on the locating mode.

Thorough knowledge of the signal curve is particularly essential for **PEAK** and **NULL** locating modes.

When using **LINE**, **SONDE**, **LINE (Peak +)**, **SONDE (Peak +)** and **MAX CAMERA** locating modes, the receiver interprets the received signals and displays information on the direction of movement.

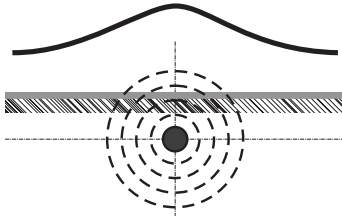

Fig. 28:  
Signal curve when using **PEAK** and  
**LINE (Peak +)** locating modes

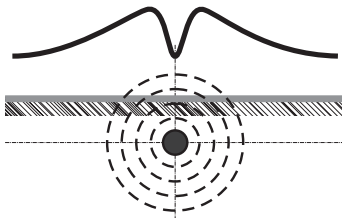

Fig. 29:  
Signal curve when using **NULL**  
locating mode

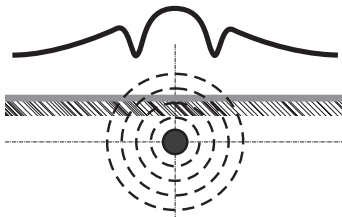

Fig. 30:  
Signal curve when using **SONDE**  
**(Peak +)** and **MAX CAMERA**  
locating modes

### 6.3 Locating in LINE mode

**LINE** mode is ideal for locating metal pipelines. The course of the line is shown on the display during the locating process. If the receiver is directly above the line, the depth of the line is shown.



**Note:**

In **LINE** locating mode only an approximate value is determined for the depth in some cases. Use the **LINE (Peak +)** locating mode to check the specified depth if you need an exact value.

The device is ready to start locating (see section 4).

1. Move away from the coupling point/**G 100**.
2. Move in a circle around the coupling point/**G 100**. Walking in this way usually means that you will pass the line twice (unless you are at the end of the line).

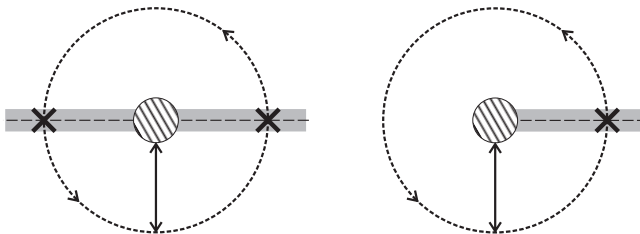

Fig. 31: Passing over a line at a central section of pipe (left) or at the end of the pipeline (right)

An acoustic signal can be heard close to the line (range). This signal changes when you pass over the line.

3. Monitor the receiver display and listen to the acoustic signal.  
The display will direct you towards the line. Move with the receiver as indicated. The ANR value increases as you get closer to a line.

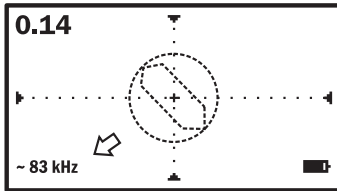

Fig. 32:  
Receiver is in the range of the field.  
The arrow shows the direction of movement.

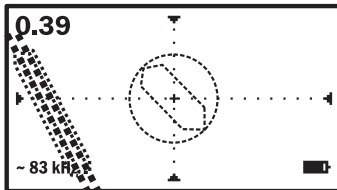

Fig. 33:  
The display shows the line to be located. Move with the receiver towards the line (in this example move to the left)

The **objective** of your movement:

- The **line** should be **centred beneath the crosshairs**.
- The **ANR value** should be at its **maximum**.

When this is the case, you have located a point on the line.

4. Keep the receiver steady over the located point on the line until the depth value has stabilised. You have calculated the **depth of the line**.

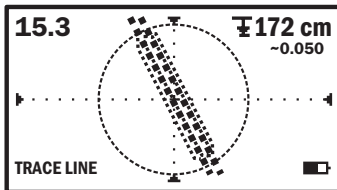

Fig. 34:  
Receiver is exactly above the line to be located (line in crosshairs). The depth of the line is shown at the top right.

You will need to calculate further points to determine the course of the line.

- Move along the line as shown on the display.
- Determine other points on the line as explained above.

## 6.4 Locating in SONDE mode

**SONDE** mode is ideal for locating sondes. The position and alignment of the sonde are shown on the display during the locating process. If the aerial is directly above the sonde, the depth of the sonde will be shown.

The device is ready to start locating (see section 5). You are close to the sonde.

An acoustic signal can be heard close to the sonde (range). This signal changes when you are directly above the sonde.

1. Monitor the receiver display and listen to the acoustic signal.

The display will direct you towards the sonde. Move with the receiver as indicated. The ANR value increases as you get closer to the sonde.

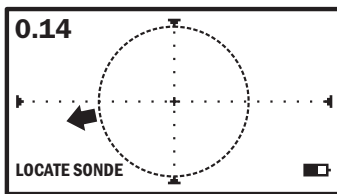

Fig. 35:  
Receiver is in the range of the field.  
The arrow shows the direction of movement.

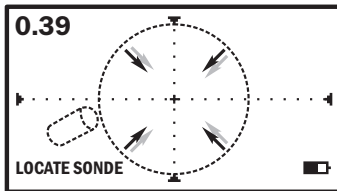

Fig. 36:  
The sonde to be located appears on the display. Move with the receiver towards the sonde (in this example move to the left)

The **objective** of your movement:

- The **sonde** should be **centred beneath the crosshairs**.
- The **ANR value** should be at its **maximum**.

When this is the case you have located the sonde.

2. Keep the receiver steady over the sonde until the depth value has stabilised. You have calculated the **depth of the sonde**.

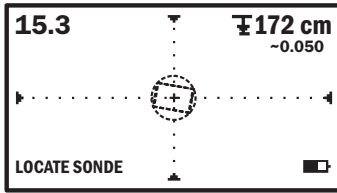

Fig. 37:  
Receiver is directly over the sonde (sonde in crosshairs). The depth of the sonde is shown at the top right.

## 6.5 Locating in LINE (Peak +) mode

**LINE (Peak +)** mode is a combination of **LINE** and **PEAK** modes. It is ideal for locating lines where the signal is weak.

The receiver directs you towards the line (same as with **LINE**). It searches for the maximum value of the relative field strength to determine the exact location of the line (same as with **PEAK**). If the receiver is directly above the line, the depth of the line is shown.

**LINE (Peak +)** is a directional locating mode. The receiver must, therefore, always be at a right angle and close to the course of the line to be located.

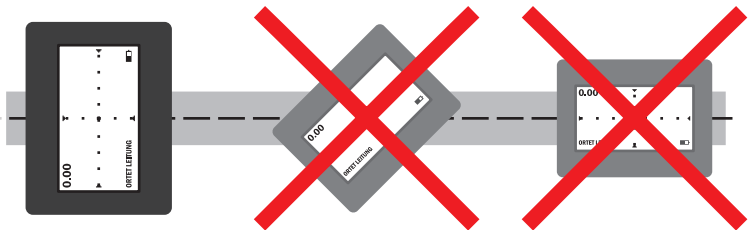

Fig. 38: **LINE (Peak +)** locating mode - receiver aligned correctly above the pipeline (left)

The device is ready to start locating (see section 4).

1. Move away from the coupling point/**G 100**.



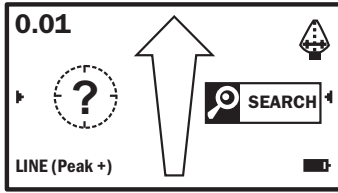

Fig. 39:  
Receiver is outside of the range of the field.

2. Move in a circle around the coupling point/**G 100**. Walking in this way usually means that you will pass over the line twice (fig. 31).

An acoustic signal can be heard close to the line (range). This signal changes when you pass over the line.

3. Monitor the receiver display and listen to the acoustic signal.

The display will direct you towards the line (visually by the centring circle and verbally in the instruction field). Move with the receiver as indicated. The ANR value increases as you get closer to a line. The signal received by the signal display should become stronger and stronger.



**Note:**

The automatic gain control works particularly well when you move the receiver continuously and steadily.

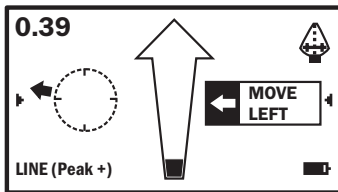

Fig. 40:  
Receiver is in the range of the field.  
Information about the direction of movement will appear in the instruction field.

The **objective** of your movement:

- The **line** should be **centred in the centring circle**.
- The **ANR value** should be at its **maximum**.
- The **signal display** should receive a **maximum signal**, i.e. the signal display should be filled.

- **ANR value** and **signal display** should have settled at stable values.

The ANR value is inverted when right beside the line.

4. Continue to move with the receiver as directed on the display.

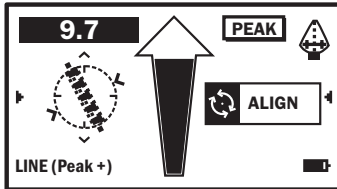

Fig. 41:  
Receiver is exactly above the line to be located (line in centring circle). The ANR value is inverted.

When this is the case, you have located a point on the line.

5. The receiver must be correctly aligned to determine the depth (fig. 38). Rotate the receiver so that the display is at a right angle to the line. Check the alignment even if you are not instructed to **ALIGN** in the instruction field.
6. Keep the receiver steady over the located point on the line until the depth value has stabilised. You have calculated the **depth of the line**.

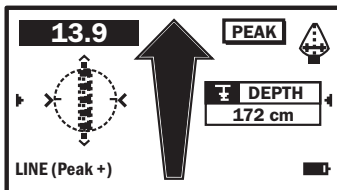

Fig. 42:  
Receiver aligned correctly above the line (pipeline vertical in centring circle). The depth of the line is shown in the instruction field.

You will need to calculate further points to determine the course of the line.

- Move along the line as shown on the display.
- Determine other points on the line as explained above.

### 6.6 Locating in SONDE (Peak +) mode

**SONDE (Peak +)** mode is a combination of **SONDE** and **PEAK** locating modes. It is ideal for locating sondes where the signal is weak.

The receiver directs you towards the sonde (same as with **SONDE**). It searches for the maximum value of the relative field strength to pinpoint exactly the sonde (same as with **PEAK**). If the receiver is directly above the sonde, the depth of the sonde is shown.

**SONDE (Peak +)** is a directional locating mode. The receiver must therefore always be parallel to the course of the line close to the sonde to be located.

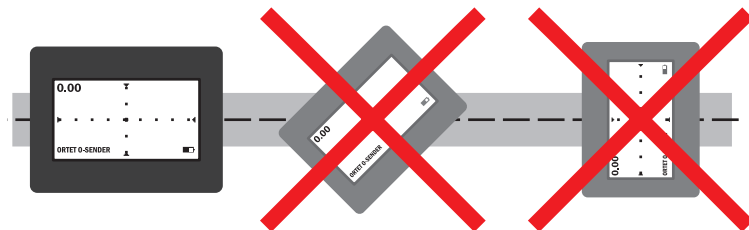

Fig. 43: **SONDE (Peak +)** locating mode - receiver aligned correctly above the line (left)

The device is ready to start locating (see section 5).

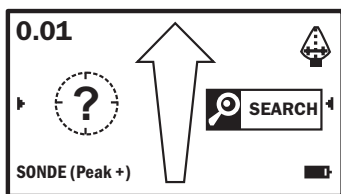

Fig. 44: Receiver is outside of the range of the field.

1. Move close to the sonde.  
An acoustic signal can be heard close to the sonde (range). This signal changes when you are directly above the sonde.
2. Monitor the receiver display and listen to the acoustic signal.  
The display will direct you towards the sonde (visually by the centring circle and verbally in the instruction field). Move with

the receiver as indicated. The ANR value increases as you get closer to the sonde. The signal received by the signal display should become stronger and stronger.

**Note:**

The automatic gain control works particularly well when you move the receiver continuously and steadily.

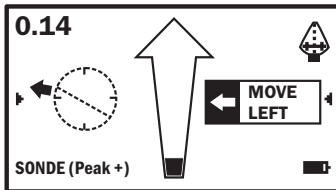

Fig. 45:

Receiver is in the range of the field. Information about the direction of movement will appear in the instruction field.

The **objective** of your movement:

- The **sonde** should be **centred in the centring circle**.
- The **ANR value** should be at its **maximum**.
- The **signal display** should receive a **maximum signal**, i.e. the signal display should be filled.
- **ANR value** and **signal display** should have settled at stable values.

The ANR value is inverted when right beside the line.

3. Continue to move with the receiver as directed on the display.

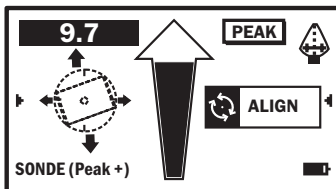

Fig. 46:

Receiver is directly over the sonde (sonde in centring circle). The ANR value is inverted.

When this is the case you have located the sonde.

- The receiver must be correctly aligned to determine the depth (fig. 43). Turn the receiver so that the display is parallel to the line with the sonde. Check the alignment even if you are not instructed to **ALIGN** in the instruction field.
- Keep the receiver steady over the sonde until the depth value has stabilised. You have calculated the **depth of the sonde**.

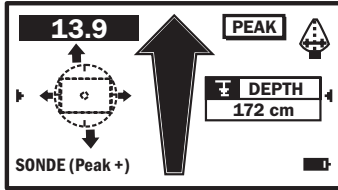

Fig. 47:  
Receiver correctly aligned above the sonde (sonde horizontal in centring circle). The depth of the sonde is shown in the instruction field.

## 6.7 Locating in MAX CAMERA mode

**MAX CAMERA** mode is intended for locating sondes. Weak electromagnetic fields can be used for location.

It searches for the maximum value of the relative field strength to pinpoint exactly the sonde (same as with **PEAK**). If the receiver is directly above the sonde, the depth of the sonde is shown.

**MAX CAMERA** is a directional locating mode. The receiver must therefore always be parallel to the course of the line close to the sonde to be located.

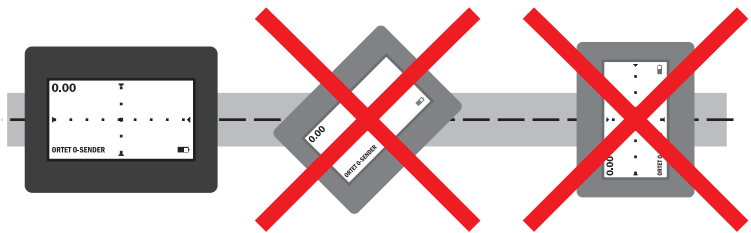

Fig. 48: **MAX CAMERA** locating mode - receiver aligned correctly above the line (left)

The device is ready to start locating (see section 5).

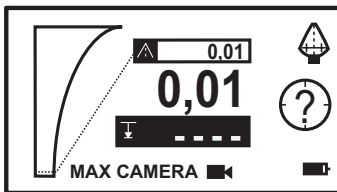

Fig. 49: Receiver is outside of the range of the field.

1. Move close to the sonde.
 

An acoustic signal can be heard close to the sonde (range).  
The sonde is visible in the centring circle.
2. Continue to move towards the sonde. Monitor the receiver display and listen to the acoustic signal.
 

The acoustic signal changes when you are directly above the sonde.

The ANR value increases as you get closer to the sonde. The signal received by the signal display becomes stronger and stronger.

In addition to the current ANR value, the maximum ANR value reached is also displayed and marked in the signal display by the slider.



**Note:**

The automatic gain control works particularly well when you move the receiver continuously and steadily.

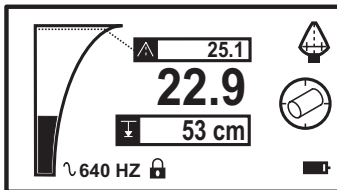

Fig. 50:  
Receiver is in the range of the field.

The **objective** of your movement:

- The **sonde** should be **centred in the centring circle** (see section 5.3).
  - The **ANR value** should be at its **maximum**. The current and maximum **ANR value** should match.
  - The **signal display** should receive a **maximum signal**, i.e. the signal display should be filled as far as the slider.
  - **ANR value** and **signal display** should have settled at stable values.
3. Move with the receiver so that you are close to the target of the movement (see above).

As soon as the sonde is displayed as a rectangle in the centring circle, you have detected the sonde.

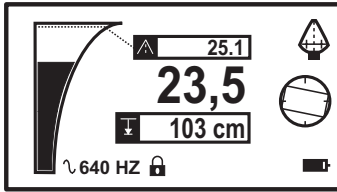

Fig. 51:  
Receiver is directly over the sonde  
(sonde in centring circle).

4. The receiver must be correctly aligned to determine the depth (fig. 48). Turn the receiver so that the display is parallel to the line with the sonde.
5. Keep the receiver steady over the sonde until the depth value has stabilised. You have calculated the **depth of the sonde**.

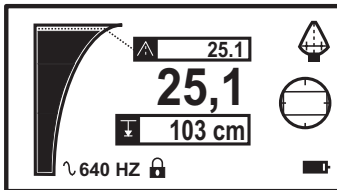

Fig. 52:  
Receiver correctly aligned above  
the sonde (sonde horizontal in cen-  
tring circle). The correct depth of the  
sonde is displayed.



### 6.8 Locating in PEAK mode

**PEAK** mode is ideal for locating lines and sondes. The receiver responds even to low signals in **PEAK** mode. This allows weak electromagnetic fields to be used for location. It also means a greater detection depth than **LINE**, **SONDE**, **LINE (Peak +)** and **SONDE (Peak +)** modes.

The display does not direct you towards the location object. The depth cannot be calculated directly.

The device is ready to start locating (see section 4/5).

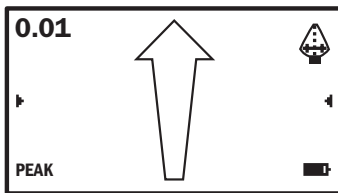

Fig. 53:  
Receiver is outside of the range of the field.

1. Move with the receiver into the range of the field.

Pipeline location:

- Move away from the coupling point/**G 100**.
- Move in a circle around the coupling point/**G 100**. Walking in this way usually means that you will pass over the line twice (fig. 31).

Locating sondes:

- Move close to the sonde.

An acoustic signal can be heard in the range of the field. This signal changes when you are directly above the sonde.

2. Continue to move towards the location object. Monitor the receiver display and listen to the acoustic signal.



**Note:**

The automatic gain control works particularly well when you move the receiver continuously and steadily.

The **objective** of your movement:

- The **ANR value** should be at its **maximum**.
- The **signal display** should receive a **maximum signal**, i.e. the signal display should be filled.

When this is the case you have located the location object.

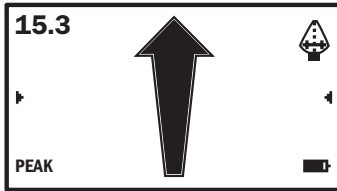

Fig. 54:  
Receiver is above the location object. ANR value and signal display are at maximum.

### 6.9 Locating in NULL mode

**NULL** mode is ideal for locating lines and sondes. The receiver responds even to low signals in **NULL** mode. This allows overlapping electromagnetic fields to be used for location.

The display does not direct you towards the location object. The depth cannot be calculated directly.

The device is ready to start locating (see section 4/5).

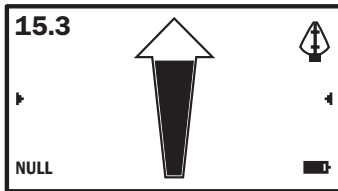

Fig. 55:  
Receiver is outside of the range of the field.

1. Move with the receiver into the range of the field.

Pipeline location:

- Move away from the coupling point/**G 100**.
- Move in a circle around the coupling point/**G 100**. Walking in this way usually means that you will pass over the line twice (fig. 31).

Locating sondes:

- Move close to the sonde.

An acoustic signal can be heard in the range of the field. This signal changes when you are directly above the sonde.

2. Continue to move towards the location object. Monitor the receiver display and listen to the acoustic signal.



**Note:**

The automatic gain control works particularly well when you move the receiver continuously and steadily.

The **objective** of your movement:

- The **ANR value** should be as **low as possible**.
- The **signal display** should receive a **minimum signal**, i.e. the signal display should be empty.

When this is the case you have located the location object.

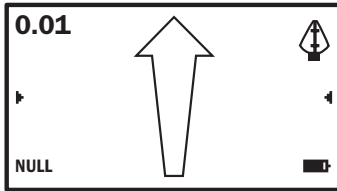

Fig. 56:  
Receiver is above the location object. ANR value and signal display are at minimum.

## 7 Troubleshooting

The occurrence of a problem when working with the **UtiliTrac** system does not always indicate a serious fault. The information below is intended to help you troubleshoot and fix faults. Please contact Sewerin Service if you cannot resolve the problem.

### 7.1 Problems with the receiver

#### 7.1.1 General problems

Problem	Possible cause	Corrective action
Cannot switch on receiver	Insufficient power supply	<ul style="list-style-type: none"> <li>• Change disposable batteries</li> <li>• Check battery contact</li> </ul>
	Processor error	<ul style="list-style-type: none"> <li>• Perform RESET</li> </ul>
Display blank	Contrast setting too low	<ul style="list-style-type: none"> <li>• Open settings menu &gt; increase contrast</li> </ul>
No acoustic signal audible	Volume at zero	<ul style="list-style-type: none"> <li>• Open settings menu &gt; increase volume</li> </ul>
Display shows unusually fluctuating values	Interference fields present	<ul style="list-style-type: none"> <li>• Eliminate interference fields: e.g. switch off computers, monitors, light dimmers, industrial appliances</li> <li>• Locate in <b>PEAK</b> or <b>NULL</b> mode instead of in <b>LINE (Peak +)</b> or <b>SONDE (Peak +), MAX CAMERA</b></li> </ul>
Signal display close to location object: – not filled or only slightly filled <b>(LINE (Peak +), SONDE (Peak +), PEAK), MAX CAMERA</b> or – completely or almost completely filled ( <b>NULL</b> )	Signal too weak	<ul style="list-style-type: none"> <li>• Move the attachment point or <b>G 100</b> towards the location object</li> </ul>
	Automatic gain control does not switch automatically to the next sensitivity range	<ul style="list-style-type: none"> <li>• Move the receiver out of the electromagnetic field for a moment (e.g. by swinging it to the side)</li> </ul>

### 7.1.2 Errors with BY SCAN frequency selection

Problem	Possible cause	Corrective action
Short, low tone (humming) audible; display not showing result	<b>G 100</b> /sonde not emitting output signal	<ul style="list-style-type: none"> <li>• Check power supply of <b>G 100</b>/sonde</li> </ul>
	Not enough current flowing through the line	<ul style="list-style-type: none"> <li>• Increase power at generator</li> </ul>
	No current in the line; line made of plastic	<ul style="list-style-type: none"> <li>• Use sonde for location</li> </ul>
	Receiver too far away from sonde	<ul style="list-style-type: none"> <li>• Hold receiver 0.5 to 1 m away from sonde</li> </ul>
Frequency determined does not correspond to frequency emitted from <b>G 100</b> /sonde	Receiver too close to sonde	<ul style="list-style-type: none"> <li>• Hold receiver 0.5 to 1 m away from sonde</li> </ul>
	Too much current flowing through the line	<ul style="list-style-type: none"> <li>• Reduce power at <b>G 100</b></li> <li>• Hold receiver further away from line</li> <li>• Adjust <b>ACTIVE (GENERATOR)</b> frequency at receiver manually</li> </ul>

7.2 Problems with the G 100

Problem	Possible cause	Corrective action
G 100 cannot be switched on	Insufficient power supply	<ul style="list-style-type: none"> <li>• Charge rechargeable battery</li> <li>• Change disposable batteries</li> </ul>
	ON key not pressed long enough	<ul style="list-style-type: none"> <li>• Press ON key for at least 1 s</li> </ul>
	Rechargeable battery has switched itself off (e.g. due to short circuit when inserted)	<ul style="list-style-type: none"> <li>• Charge battery briefly: connect charger and remove again immediately</li> </ul>
Direct energizing not working	Line is not electro-conductive	<ul style="list-style-type: none"> <li>• Use sonde for location</li> </ul>
	<b>G 100 cable set</b> faulty	<ul style="list-style-type: none"> <li>• Replace faulty <b>G 100</b> cable set</li> </ul>
	<b>G 100 cable set</b> not correctly connected	<ul style="list-style-type: none"> <li>• Check connection of <b>G 100 cable set</b></li> </ul>
Inductive energizing not working	<b>G 100</b> set to direct energizing	<ul style="list-style-type: none"> <li>• Remove cables from direct output sockets</li> </ul>
	<b>G 100</b> faulty	<ul style="list-style-type: none"> <li>• Check that <b>G 100</b> is working: Switch on <b>G 100</b> and receiver &gt; Hold receiver aerial towards <b>G 100</b> from approx. 2.5 m &gt; Receiver must receive a signal of the same frequency</li> </ul>
<b>G 100</b> switches off during the locating process	Insufficient power supply	<ul style="list-style-type: none"> <li>• Reduce power at <b>G 100</b></li> <li>• Charge rechargeable battery</li> <li>• Change disposable batteries</li> </ul>

## 8 Appendix

### 8.1 Specifications and permitted operating conditions

#### 8.1.1 Receiver

Protection rating:	IP54
Power supply:	8 disposable alkaline batteries, type: mignon/ LR6/AA
Operating time:	10 - 20 h
Weight:	1.9 kg (incl. batteries)
Dimensions (W × H × D):	10 × 54 × 23 cm folded down 10 × 90 × 23 cm unfolded
Display dimensions (W × H):	7 × 4 cm
Operating temperature:	-20 °C – +70 °C
Storage temperature:	-20 °C – +70 °C
Frequency range:	512 Hz - 200 MHz

#### 8.1.2 G 100 generator

Protection rating:	IP54
Power supply:	either: <ul style="list-style-type: none"> <li>● <b>G 100 rechargeable battery:</b> Li-Ion 45 Wh</li> <li>● Disposable batteries: 8x Baby/LR14/C also possible: externally via <b>G 100 vehicle cable</b></li> </ul>
Operating time:	3 – 36 h
Weight:	5 kg (with <b>G 100 rechargeable battery</b> )
Dimensions (W × H × D):	62 × 32 × 12 cm
Operating temperature:	-20 °C – +60 °C
Storage temperature:	-20 °C – +60 °C
Transmitting power:	up to 10 W
Frequency range:	512 Hz - 200 MHz



## 8.2 Available frequencies

### 8.2.1 Receiver

#### 8.2.1.1 Active frequencies

Frequency	Remark
512 Hz	
640 Hz	
1.1 kHz [C]	• Frequency of FERROPHON G1/G2
8 kHz	
9.8 kHz	
9.95 kHz [B]	• Frequency of FERROPHON G1/G2
33 kHz	
41.66 kHz [A]	• Frequency of FERROPHON G1/G2
51.2 kHz	
65 kHz	
82 kHz	
82.3 kHz	
83 kHz	
98.2 kHz	
116 kHz	
126 kHz	
200 kHz	

### 8.2.1.2 Passive frequencies

Passive frequencies can only be used for pipeline location.

If a passive frequency is selected the receiver automatically specifies a locating mode for lines. You can change from one locating mode to another via the settings menu.

Frequency	Remark
50 Hz 1-phase 60 Hz 1-phase *)	<ul style="list-style-type: none"> <li>• For locating single-phase power lines</li> <li>• Good locating results with stable load</li> </ul>
50 Hz 60 Hz *)	<ul style="list-style-type: none"> <li>• For locating single-phase and three-phase power lines</li> <li>• Good locating results with unstable load</li> </ul>
50 Hz + 60 Hz + *)	<ul style="list-style-type: none"> <li>• For locating three-phase power lines</li> </ul>
50 Hz < 80 KV 60 Hz < 80 KV *)	<ul style="list-style-type: none"> <li>• For locating high-voltage power lines</li> </ul>
50 Hz > 50 KV 60 Hz > 50 KV *)	<ul style="list-style-type: none"> <li>• For locating high-voltage power lines</li> </ul>
RADIO	<ul style="list-style-type: none"> <li>• Frequency range 11.6 – 31.4 kHz (VLF range)</li> </ul>
CPS	<ul style="list-style-type: none"> <li>• DC 100 Hz, synchronised</li> </ul>
CATV	<ul style="list-style-type: none"> <li>• For locating cable TV pipelines</li> <li>• Frequency range 30.275 – 34.65 kHz</li> </ul>

\*) Special frequency

#### Note on the location of power lines and high-voltage power lines

SEWERIN recommends trying out all available **50 Hz frequencies** (alternatively: 60 Hz frequencies) at the start of the locating process. Although in theory each frequency is ideally suited for a particular locating situation, in practice another frequency can sometimes receive more stable signals and therefore deliver more accurate results.

8.2.2 G 100 generator

Frequency	
Direct energizing	Inductive energizing
512 Hz	
640 Hz	
8 kHz	8 kHz
33 kHz	33 kHz
51.2 kHz	
65 kHz	
83 kHz	
116 kHz	116 kHz
126 kHz	
131 kHz	
200 kHz	

### 8.3 Accessories



#### Sonde

Art. no.: on request

- Different models available for various applications and location depths



#### Fibre glass rods

Art. no.: on request

- Models:
  - 60 m long with 4.5 mm or 6 mm diameter
  - 100 m long with 6 mm diameter
- Mounted on reel



#### Sheaths for fibre glass rods

Art. no.: on request

- For inserting fibre glass rods into pressurised lines (up to 10 bar)
- Connection thread 1" (external thread)



#### G 100 rechargeable battery

Art. no.: SU01-Z1000

- Lithium-ion rechargeable battery



### **G 100 battery case**

Art. no.: 9081-0020

- Required to power the **G 100 generator** with disposable batteries
- Holds 8 batteries Baby/LR14/C



### **G 100 vehicle cable**

Art. no.: 9081-0009

- For powering the **G 100 generator** with 12 V=

### **G 100 AC/DC adapter**

Art. no.: on request

- For powering the **G 100 generator** from the mains



### **75 W inverter**

Art. no.: 9042-0041

- For charging the **G 100 rechargeable battery** in vehicle
- Converts 12 V= into 230 V~/50 Hz
- Input: plug for vehicle socket, output: socket outlet with earthing contact
- With low voltage cut-out

**Vehicle twin coupler 12 V=**

Art. no.: 9042-0042

- Max. 2 × 8 A
- Input: plug for vehicle socket, output: 2 couplers for vehicle socket

**Vehicle extension cable 12 V=**

Art. no.: 9042-0043

- Max. 8 A
- Max. length 3 m
- Input: plug for vehicle socket, output: coupler for vehicle socket

**G 100 cable set**

Art. no.: 9081-0014

- For energizing
- With plug for connecting to **G 100 generator** and 2 terminal clamps
- Two G 100 cable sets are required for simultaneously energizing two pipelines

**Cable clamp AZ 135**

Art. no.: SS16-10000

- For energizing pipelines and cables up to 135 mm in diameter



**G 100 side pocket**

Art. no.: 9081-0008

- For holding accessories (e.g. **G 100 cable set, cable clamp AZ 135**)
- Fixed to outside of **G 100 generator** or carrying case

Other accessories are available for the device. Please contact our sales department for further information.

#### 8.4 EU declaration of conformity

Hermann Sewerin GmbH hereby declares that the **UtiliTrac** system fulfils the requirements of the following guidelines:

- 2014/30/EU
- 2014/35/EU

The complete declaration of conformity can be found online ([www.sewerin.com](http://www.sewerin.com)).

#### 8.5 Advice on disposal

The European Waste Catalogue (EWC) governs the disposal of appliances and accessories.

Description of waste	Allocated EWC waste code
Device	16 02 13
Disposable battery, rechargeable battery	16 06 05

#### End-of-life equipment

Used equipment can be returned to Hermann Sewerin GmbH. We will arrange for the equipment to be disposed of appropriately by certified specialist contractors free of charge.



## 8.6 Terminology and abbreviations

<b>ANR</b>	<ul style="list-style-type: none"> <li>• Abbreviation for: absolute field strength (absolute numeric response) of the signal received</li> <li>• Value can be between 0 and 15,000</li> </ul>
<b>Attachment point</b>	<ul style="list-style-type: none"> <li>• Point at which the cable set etc. is connected to the open end of the line</li> </ul>
<b>CPS</b>	<ul style="list-style-type: none"> <li>• Abbreviation for: Cathodic Corrosion Protection</li> </ul>
<b>Direct energizing</b>	<ul style="list-style-type: none"> <li>• Also known as: galvanic energizing</li> </ul>
<b>Direction of movement</b>	<ul style="list-style-type: none"> <li>• Specifies the direction in which the receiver is to be moved to find the location object</li> <li>• Appears as visual or verbal information for <b>LINE</b>, <b>SONDE</b>, <b>LINE (Peak +)</b>, <b>SONDE (Peak +)</b> and <b>MAX CAMERA</b> locating modes</li> </ul>
<b>External resistance</b>	<ul style="list-style-type: none"> <li>• Total resistance (excluding resistance in generator)</li> <li>• Depends on the moisture of the soil, length and material of connection cable, material and coating of the line, transfer resistance at attachment point etc.</li> </ul>
<b>Firmware</b>	<ul style="list-style-type: none"> <li>• Receiver's internal software</li> </ul>
<b>Input signal</b>	<ul style="list-style-type: none"> <li>• Signal received by the receiver</li> </ul>
<b>Line</b>	<ul style="list-style-type: none"> <li>• Generic term for cables and pipes</li> </ul>
<b>Location frequency</b>	<ul style="list-style-type: none"> <li>• Frequency with which the line to be located is directly or inductively energized</li> </ul>
<b>Output signal</b>	<ul style="list-style-type: none"> <li>• Signal emitted by the generator or sonde</li> </ul>
<b>Range</b>	<ul style="list-style-type: none"> <li>• Area in which the signals of the electromagnetic field are recorded by the receiver</li> </ul>
<b>Scan</b>	<ul style="list-style-type: none"> <li>• Receiver function which determines the frequency of the output signal</li> <li>• Automatically aligns the frequencies of the transmitter and receiver</li> </ul>
<b>Sonde</b>	<ul style="list-style-type: none"> <li>• Battery-powered transmitter inserted inside a pipe to locate a line.</li> <li>• Also: mini pig transmitter</li> </ul>
<b>VLF</b>	<ul style="list-style-type: none"> <li>• Abbreviation for: Very Low Frequency</li> </ul>

---

## 9 Index

### A

- Absolute field strength *see* ANR value
- Aerial
  - extending 20
- ALIGN (instruction) 13
- ANR value 11

### B

- Backlight threshold 23
  - setting 25
- bAt 31
- Batteries (G 100 generator) 31
  - charging 31
  - replacing 31
- Batteries (receiver) 20
  - replacing 20
- Battery symbol 12
- BY SCAN (frequency selection) 17
  - error 61

### C

- Cable clamp AZ 135 28
- Carrying case 26
- CATALOG (frequency selection) 18
- Centring circle 11
- Click 5
- Communication socket 6
- Components 2
- Connector panel 6, 28
- Contrast 23
  - setting 25
- Control panel 27
- Cover caps 26
- Crosshairs 11
- Current 30

### D

- Depth 15
  - accuracy 16
- DEPTH (instruction) 13
- DETECTED (information) 14
- Device information 23
- Direct energizing 27, 28, 36
- DIRECT (information) 27

- Direct output sockets 28
- Display (G 100 generator) 27
- Display (receiver) 4
  - backlight 23
  - contrast 23
  - for LINE 7
  - for LINE (Peak +) 8
  - for MAX CAMERA 9
  - for NULL 10
  - for PEAK 10
  - for SONDE 7
  - for SONDE (Peak +) 8
- DOWN key 27

### F

- Favorites 18
- Firmware
  - restarting 6
- Frequency (G 100 generator)
  - overview 66
  - selecting 33
- Frequency (receiver)
  - active 64
  - favorites 18
  - overview 64
  - passive 22, 65
  - selecting 17, 18, 23, 24

### G

- G 100 *see* Generator G 100
  - switching off 32
- G 100 cable set 28
- Gain control
  - automatic 4
- General 23
  - selecting 24
- Generator G 100
  - current 30
  - frequencies 29
  - keys 27
  - modes 29
  - power output 29, 33
  - power supply 30, 32
  - problems 62
  - switching mode 33
  - switching on 32

### H

Headphone socket 6

### I

Inductive energizing 27, 28, 37  
INDUCTIVE (information) 27  
Inductors 4  
Inductor symbol 13  
Information about the device *see* Device information  
Information field 14  
Instruction field 13  
INTERFERENCE (information) 14

### L

Language  
  selecting 23  
LINE (locating mode) 44  
LINE (Peak +) (locating mode) 47  
Locate  
  with LINE 44  
  with LINE (Peak +) 47  
  with MAX CAMERA 53  
  with NULL 58  
  with PEAK 56  
  with SONDE 46  
  with SONDE (Peak +) 50, 53  
Locate line 35, 38  
  procedure 35  
  requirement 35  
  sources of error 38  
Locate sonde 39  
  procedure 39  
  representation in centring circle 40  
  sources of error 41  
Locating mode  
  overview 42  
  selecting 23, 24  
Location frequency *see* Generator  
  G 100: Frequencies

### M

MAX CAMERA (locating mode) 53  
MOVE AHEAD (instruction) 13  
MOVE BACK (instruction) 13  
MOVE LEFT (instruction) 13  
MOVE RIGHT (instruction) 13

### N

NULL (locating mode) 58

### O

OFF key 27  
ON key 27  
Output power *see* Power output  
Output signal 34

### P

PEAK (information) 14  
PEAK (locating mode) 56  
Pipeline location *see* Locate line  
Power output 29  
  selecting 33  
Press 5  
Pulse function 34  
  switching off 34  
  switching on 34  
PULSE key 27  
Purpose 2

### R

Receiver  
  aerial 20  
  battery change 20  
  frequencies 17  
  power supply 20  
  problems 60  
  switching off 22  
  switching on 21  
Rechargeable battery 30  
Relative field strength *see* Signal display  
Reset 6

### S

SEARCH (instruction) 13  
SELECT key 27  
Sensitivity *see* Gain control  
Settings menu 23  
Signal curve 43  
Signal display 12  
Signal quality 11  
Socket  
  communication 6  
  direct output 28  
  for accessories 6

for direct current power supply 28

headphone 6

Sonde *see* Locate sonde

SONDE (locating mode) 46

SONDE (Peak +) (locating mode) 50,  
53

Switching mode 33

## T

Time symbol 15

Transmitter *see* Generator G 100

Trigger 5

click 5

press 5

Troubleshooting 60

## U

Unit of length

selecting 23

UP key 27

Use

intended 2

## V

Volume 4, 23

setting 25

**Hermann Sewerin GmbH**  
Robert-Bosch-Straße 3 · 33334 Gütersloh · Germany  
Telefon +49 5241 934-0 · Telefax +49 5241 934-444  
[www.sewerin.com](http://www.sewerin.com) · [info@sewerin.com](mailto:info@sewerin.com)