

SeCorr[®]
C 200 receiver
RT 200 transmitter



C 200 receiver

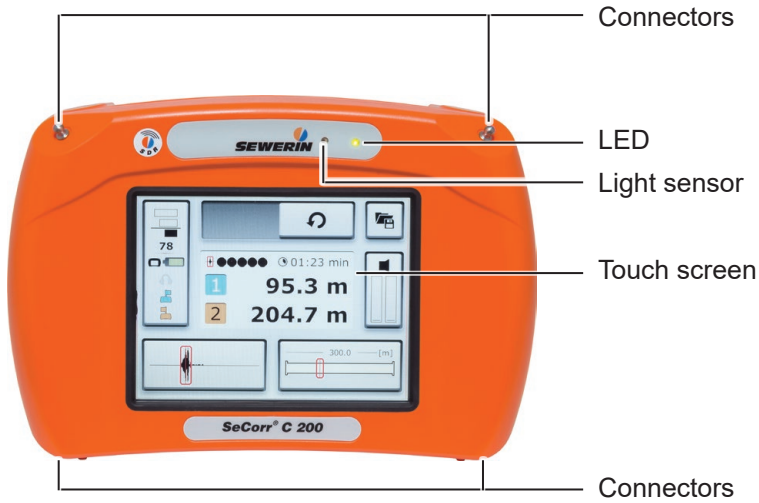

Fig. 1: C 200 receiver without aerial, front

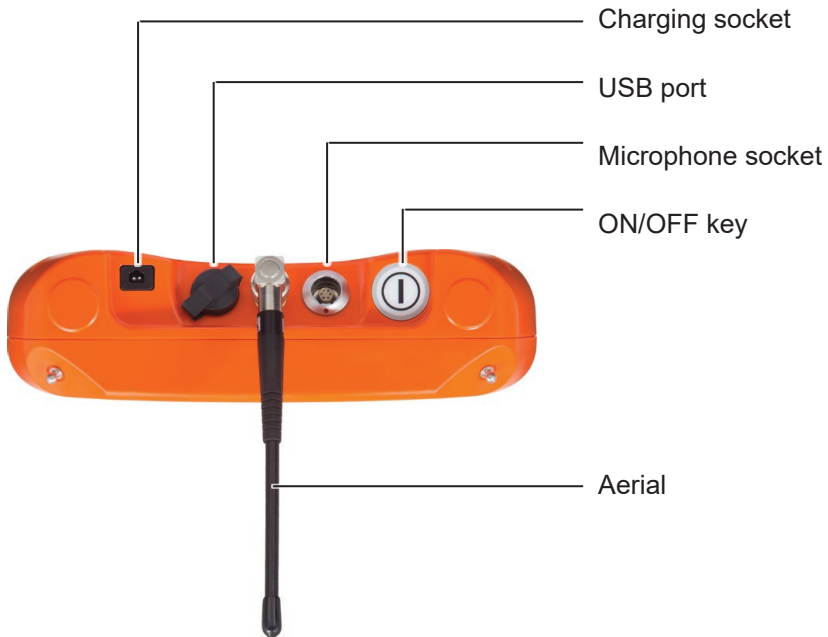

Fig. 2: C 200 receiver, top view

RT 200 transmitter

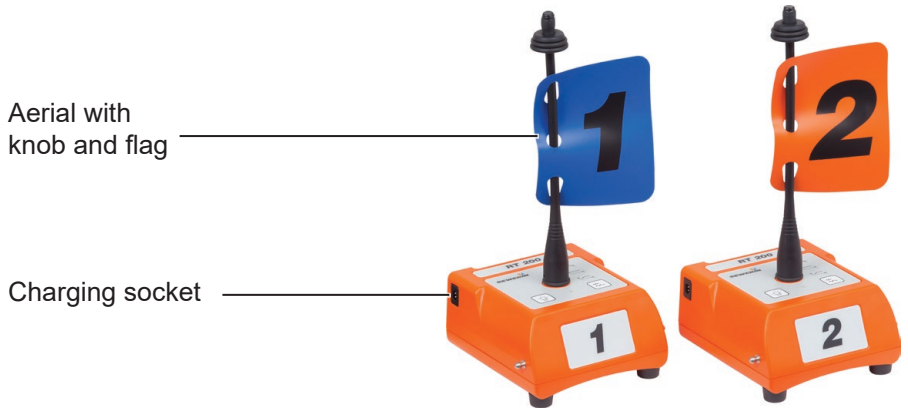

Fig. 3: Transmitter 1 with blue flag and transmitter 2 with orange flag

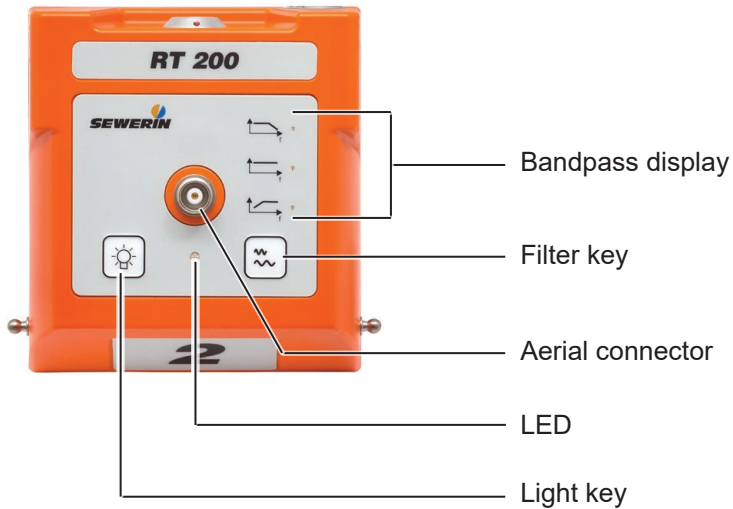

Fig. 4: RT 200 transmitter without aerial, top view

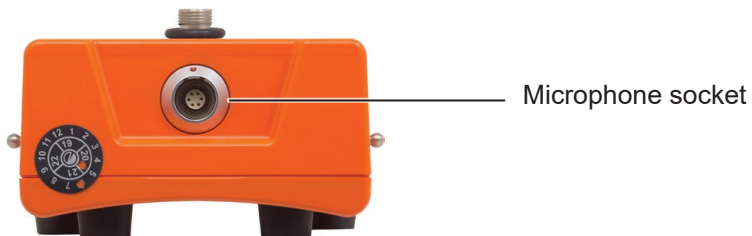

Fig. 5: RT 200 transmitter, back

Information about this document

The warnings and notes in this document mean the following:



WARNING!

Risk of personal injury. Could result in serious injury or death.



CAUTION!

Risk of personal injury. Could result in injury or pose a risk of health.

NOTICE!

Risk of damage to property.

Note:

Tips and important information.

Numbered lists (numbers, letters) are used for:

- Instructions that must be followed in a certain order

Lists with bullet points (point, dash) are used for:

- Lists
- Instructions that only involve one step

1	Introduction	1
1.1	Warranty	1
1.2	Purpose	2
1.3	Intended use	2
1.4	General safety information	3
1.5	Radio communication	4
2	SeCorr system	5
2.1	General information about the system	5
2.2	System components	5
2.2.1	Overview	5
2.2.2	C 200 receiver	6
2.2.2.1	Setup	6
2.2.2.2	Carrying the system	8
2.2.2.3	Automatic power off	9
2.2.2.4	Main view	9
2.2.2.5	How interference suppression works	15
2.2.3	RT 200 transmitter	15
2.2.3.1	Setup	16
2.2.3.2	Switching the transmitter on and off	17
2.2.4	Microphones	18
2.2.4.1	UM 200 universal microphone	18
2.2.4.2	HY 200 hydrophone	19
2.3	Switching on and off	19
2.3.1	Receiver	19
2.3.2	Transmitter	20
2.4	Filter options (overview)	20
2.5	Plug connection between microphone and RT 200 transmitter	20
2.6	Power supply to the components	21
3	Using the system	22
3.1	Preparing the system	22
3.2	Measurement steps (overview)	22
3.3	Configuring the pipe sections	22
3.3.1	Setting the number of pipe sections	23
3.3.1.1	Adding a pipe section	24
3.3.1.2	Deleting a pipe section	24
3.3.2	Adjusting the pipe data	25

3.4	Performing a measurement.....	25
3.4.1	Starting a measurement.....	26
3.4.1.1	Starting the measurement after configuring pipe sections	26
3.4.1.2	Continuing measurement.....	26
3.4.1.3	Repeating a measurement.....	27
3.4.2	Stopping a measurement.....	27
3.4.3	Saving a measurement.....	27
3.4.3.1	Loading a saved measurement.....	28
3.4.3.2	Deleting a saved measurement.....	30
3.5	Optimising the correlation result using filters.....	31
3.5.1	Filter menu (overview).....	31
3.5.1.1	Frequency graph.....	33
3.5.1.2	Correlation curve.....	34
3.5.1.3	Quality of peak.....	34
3.5.2	Selecting and adjusting filters.....	34
3.5.2.1	Selecting automatically calculated filters.....	35
3.5.2.2	Manually adjusting filters.....	35
3.5.2.3	Applying the filters (exiting the Filter menu).....	38
3.6	Plausibility check.....	38
3.6.1	Moving the marker.....	38
3.6.2	Hide peak.....	39
3.6.3	Sound velocity measurement.....	40
3.6.3.1	Artificial leak outside of the measuring section.....	41
3.6.3.2	Artificial leak within the measuring section.....	41
3.7	Listening to noises.....	42
3.7.1	Information about the radio connection during listening.....	42
3.7.2	Transmitter menu (overview).....	42
3.7.3	Adjusting the volume.....	44
3.7.4	Selecting a transmitter.....	45
3.8	Microphone function for acoustic leak detection.....	45
3.8.1	Microphone menu (overview).....	46
3.8.2	Performing a noise measurement.....	47
3.9	Locking and unlocking the display.....	48
4	Settings.....	49
4.1	Overview.....	49
4.2	Setting actions.....	49
4.2.1	Selecting.....	50
4.2.2	Enabling/disabling.....	50
4.2.3	Setting a value.....	50
4.3	Settings in the Measurement menu.....	52

4.3.1	General	53
4.3.1.1	Units	53
4.3.1.2	Interference suppression.....	53
4.3.1.3	Correlation curve.....	54
4.3.1.4	Blocking filter.....	54
4.3.2	Filter basis.....	54
4.3.2.1	Coherence.....	55
4.3.2.2	Cross spectrum	55
4.3.2.3	Spectrum 1 or Spectrum 2	55
4.3.2.4	Sound velocity.....	55
4.3.3	Pipe data (Default)	56
4.3.3.1	Length	56
4.3.3.2	Material	56
4.3.3.3	Diameter.....	56
4.3.3.4	Sound velocity.....	56
4.4	Settings in the Device menu	56
4.4.1	General	58
4.4.1.1	Switching off the device	58
4.4.1.2	Switching off the backlight.....	58
4.4.1.3	Automatic brightness.....	59
4.4.1.4	Brightness	59
4.4.2	Time/Date.....	59
4.4.2.1	Time	59
4.4.2.2	Date.....	59
4.4.3	Region.....	60
4.4.3.1	Date format	60
4.4.3.2	Time format.....	60
4.4.3.3	Language	60
4.4.4	Service	60
4.4.4.1	Information	60
4.4.4.2	Calibration.....	61
5	Maintenance	62
5.1	Charging the batteries.....	62
5.1.1	Charging the batteries in the case	62
5.1.2	Charging batteries using the AC/DC adapter or vehicle cable.....	63
5.2	Handling faulty lithium-ion rechargeable batteries	64
5.2.1	Identifying faulty batteries	64
5.2.2	Removing the batteries from the C 200 receiver.....	65
5.2.3	Removing the battery from the RT 200 transmitter	66
5.3	Calibrating the touch screen	67

5.4	Care	68
5.5	Maintenance.....	68
6	Appendix.....	69
6.1	Technical data	69
6.1.1	C 200 receiver.....	69
6.1.2	RT 200 transmitter.....	71
6.1.3	UM 200 universal microphone	73
6.1.4	HY 200 hydrophone	74
6.2	Symbols on the touch screen of the C 200 receiver	75
6.3	Significance of LED signals.....	77
6.3.1	C 200 receiver.....	77
6.3.2	RT 200 transmitter.....	78
6.4	Troubleshooting.....	79
6.5	Accessories	79
6.6	Declaration of conformity	79
6.7	Licences in the EEA	80
6.8	Note about the firmware (open source software)	81
6.9	Advice on disposal	81
7	Index.....	82

1 Introduction

1.1 Warranty

The following instructions must be complied with in order for any warranty to be applicable regarding functionality and safe operation of this equipment.

- Read these operating instructions prior to operating the product.
- Use the product only as intended.
- Repairs and maintenance must only be carried out by specialist technicians or other suitably trained personnel. Only spare parts approved by Hermann Sewerin GmbH may be used when performing repairs.
- Changes or modifications to this product may only be carried out with the approval of Hermann Sewerin GmbH.
- Use only Hermann Sewerin GmbH accessories for the product.

Hermann Sewerin GmbH shall not be liable for damages resulting from the non-observance of this information. The warranty conditions of the General Terms and Conditions (AGB) of Hermann Sewerin GmbH are not broadened by this information.

In addition to the warnings and other information in these Operating Instructions, always observe the generally applicable safety and accident prevention regulations.

The manufacturer reserves the right to make technical changes.

1.2 Purpose

SeCorr is a system used for correlation.

The **SeCorr** system can be used for:

- Detecting leaks in water pipes
-

Note:

All descriptions in these operating instructions refer to the system as delivered (factory settings). The operating instructions apply to the **C 200** receiver with firmware version 2.x and higher. The manufacturer reserves the right to make changes.

1.3 Intended use

The **SeCorr** system is intended for professional industrial and commercial use. The appropriate specialist knowledge is required to operate the system.

Note:

If necessary, learn more about the principles of the technology before commencing practical work with the system.

The system must only be used for the applications specified in section 1.2.

1.4 General safety information

This product was manufactured in keeping with all binding legal and safety regulations. It corresponds to the state of the art and complies with conformity requirements. The product is safe to operate when used in accordance with the instructions provided.

However, if you handle the product improperly or not as intended, the product may present a risk to persons and property. For this reason, observe the following safety information without fail.

Risk of personal injury (health risk)

- Handle the components carefully and safely both during transport and when working.
- Proceed with extreme caution in the vicinity of electrical lines.

Hazards for the product and other property

- Always handle the components carefully.
- Do not drop the components.
- Do not place the components in places where they are at risk of falling.
- The aerials of the **C 200** receiver and **RT 200** transmitter must not be damaged.
 - Never bend, kink or cut the aerial.
 - Never carry the **C 200** receiver by its aerial.
- Before starting work, check that the components are in good working order. Never use damaged or defective components.
- Ensure that no dirt or moisture gets into the connections on the components.
- Always observe the permitted operating and storage temperatures.

1.5 Radio communication

The **SeCorr** system uses the following data transmission technologies:

- Near-field radio
- SDR (Sewerin Digital Radio)

Near-field radio

The transmitter and receiver communicate by near-field radio. The **RT 200** transmitter is classed as radio equipment according to EU Directive 2014/53/EU. It may, therefore, be subject to some use restrictions.

Note:

Users of the **SeCorr** system are responsible for ensuring compliance with local country regulations regarding the registration and use of radio equipment. This applies even if there is an explicit licence for a country.

You can find a list of the countries of the European Economic Area (EEA) where this equipment is licensed for use in section 6.7 on page 80.

Note:

Radio systems that use the same frequencies can interfere with each other.

- Switch off the transmitters when not in use.
-

SDR radio

Receivers and wireless headphones communicate by bidirectional SDR (SDR: Sewerin Digital Radio). SDR is only used when listening to noises.

For more detailed information about the special features of this radio connection, please refer to section 3.7.1 on page 42.

2 SeCorr system

2.1 General information about the system

The **SeCorr** system works using the correlation method, whereby measurements are taken at two fittings (e.g. slide gate, hydrant) at the same time. Highly sensitive microphones record the noises at the fittings. The two microphones are each connected to a radio transmitter. The radio transmitters transmit the signals to a receiver – the correlator. The correlator determines the run time difference between the signals, i.e. the time lag between the noises reaching the two measuring points. This is then used, together with the pipe data, by the correlator to calculate the leak position.

The advantage of the correlation method is that the leak position is determined independently of the hearing and experience of the user.

The system features a function which can also locate leaks acoustically if there is no suitable technology available specifically for pinpointing or prelocation.

2.2 System components

2.2.1 Overview

SeCorr is a modular system. The main system components are as follows:

- **C 200** receiver (correlator)
- 2 **RT 200** transmitters (1 pair)
 - Transmitter 1 with blue flag
 - Transmitter 2 with orange flag
- 2 microphones, e.g.:
 - **UM 200** universal microphone

OR

- **HY 200** hydrophone

One microphone is required for each **RT 200** transmitter. The same type of microphone must always be used for the two transmitters.

- **F8** wireless headphones (optional)
- **AC 200 SK 4** case

The system can be transported and stored in the case. The batteries for the components **C 200**, **RT 200** and **F8** can be simultaneously charged in the case using the AC/DC adapter **L**.

Accessories can be added to the system at any time.

Note:

Information about **F8** wireless headphones can be found in the relevant operating instructions.

2.2.2 **C 200 receiver**

The **C 200** receiver receives data from the **RT 200** transmitter. The receiver calculates the leak position from the run time difference between the signals of the two receivers.

The **C 200** receiver is also known as a correlator.

2.2.2.1 **Setup**

Overviews with the names of all the parts of the receiver can be found inside the front cover (fig. 1 and fig. 2).

Its symmetrical housing means that it can be operated by both right-handed and left-handed users with ease.

Touch screen

The receiver features a touch screen. Certain areas of the touch screen are touch-sensitive. Actions are performed by touching these areas (buttons).

All of the buttons have a thick, dark grey outline.

Only your finger or a touch pen should be used to operate the touch screen.

- Always touch the buttons briefly without exerting too much pressure.

NOTICE! Risk of damage

The surface of the touch screen is sensitive.

- Do not use any hard or sharp objects (e.g. pens) to operate the screen.
 - Protect the touch screen against aggressive substances (e.g. acidic or abrasive detergents).
-

An overview with the symbols that might appear on the touch screen can be found in section 6.2 on page 75.

Light sensor

The light sensor analyses the ambient lighting conditions.

If the automatic brightness setting is enabled, the light sensor always adjusts the brightness of the touch screen to the ambient lighting conditions.

Information about the automatic brightness setting can be found in section 4.4.1.3 on page 59.

ON/OFF key

The ON/OFF key has the following functions:

- Switching the receiver on and off
- Locking and unlocking the display

LED

The LED indicates the operating status.

Information about what the LED signals mean can be found in section 6.3.1 on page 77.

Aerial

When using the receiver, the aerial must be pointing upwards (fig. 6). It can be folded down for storage in the case.



Fig. 6: Receiver in its normal position of use
The aerial is pointing upwards.

Ports

The receiver features the following ports:

- Charging socket
For charging the rechargeable battery.
- Microphone socket
For connecting a microphone, e.g. **UM 200** universal microphone.
- USB port
For connecting to a computer.

Connectors

Carrying systems (**Vario**, lap belt), the **triangle 200** carrying strap or a hand loop can be attached to the connectors.

The connectors are parts of the quick-release fasteners.

2.2.2.2 Carrying the system

The receiver is usually carried in front of the body so that the user looks diagonally down at the touch screen.

SEWERIN recommends: Use a carrying system for locating operations. The carrying system prevents you from tiring during work. It also reduces the possibility of radio interference. Radio interference can occur if the user accidentally covers certain components in the receiver.

2.2.2.3 Automatic power off

The power supply to the receiver is designed in such a way that a fully charged battery will allow one full day's work without interruption. However, it is still recommended to conserve energy whilst working.

The receiver therefore offers the following automatic power-off options:

- **Switching off the device**

The receiver switches off if it is not operated for a specified period of time. It must be switched back on again when you want to continue work.

- **Switching off the backlight**

The receiver backlight switches off if it is not operated for a specified period of time. The receiver remains switched on.

If and when the automatic power off is activated depends on the settings (**Device menu > General > Switch off device or Switch off backlight**).

2.2.2.4 Main view

The touch screen of the receiver displays the main view when the system is ready for use.

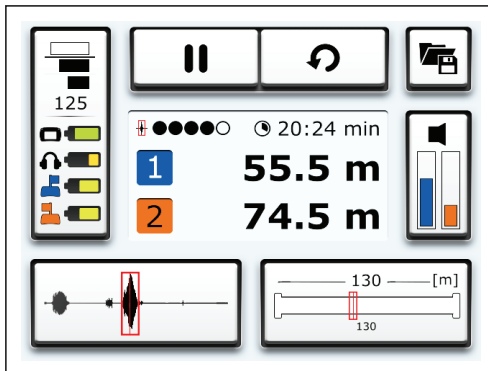

Fig. 7: Main view

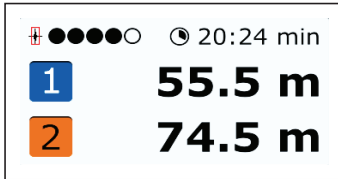

Fig. 8: Results display (detail of main view)

The following is shown in the centre of the main view (fig. 8):

- Leak position
 - Distance of leak from transmitter 1 and transmitter 2
- Quality of peak
- Duration of measurement

The main view also contains the following buttons:

- **Measurement**
- **File**
- **Transmitter**
- **Pipe sections**
- **Filter**
- **Settings**

These buttons can be used to open submenus. Most of the buttons also display information. The information displayed depends on the situation.

Measurement

The **Measurement** button is divided into different sections. The appearance of the **Measurement** button depends on what the program is doing (fig. 9).

- **Start measurement** button
 - OR
 - Stop measurement** button
- **Reset** button

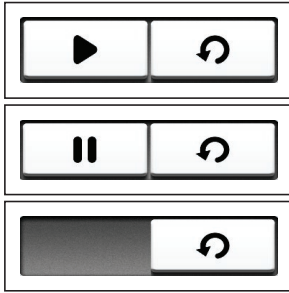

Fig. 9: **Measurement** button at various stages of the program
 Top image: A measurement can be started.
 Centre image: A measurement can be stopped.
 Bottom image: The calculation data must be reset before a measurement can be started.

For more detailed information on performing measurements, please refer to section 3.4 on page 25.

File

The **File** menu is opened by pressing the **File** button. The following actions can be performed in this menu:

- Save measurement
- Load saved measurement
- Delete saved measurement



Fig. 10: **File** button

For information about saving, loading and deleting measurements, please refer to section 3.4.3 on page 27.

Transmitter

The **Transmitter** button displays the following information:

- Current noise level of the transmitters
 - Left: Transmitter 1 (blue)
 - Right: Transmitter 2 (orange)

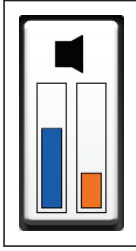

Fig. 11: **Transmitter** button

The **Transmitter** menu is opened by pressing the **Transmitter** button. The following settings can be made in this menu:

- Transmitters from which noises can be heard through headphones
- Volume of noise on headphones

Information about the two transmitters is also displayed.

For more detailed information about the **Transmitter** menu and listening to noises, please refer to section 3.7 on page 42.

Pipe sections

The **Pipe sections** button displays the following information:

- Total length of measuring section
- Number and length of pipe sections
- Marker

Indicates the leak position in the pipe section concerned.

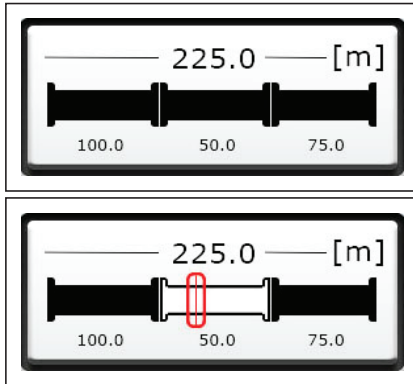

Fig. 12: **Pipe sections** button, *here*: Measuring section with three pipe sections
 Top image: Before starting a measurement.
 Bottom image: After starting/stopping a measurement

The **Pipe sections** menu is opened by pressing the **Pipe sections** button. The following settings can be made in this menu:

- Number of pipe sections in a measuring section
- Pipe data for every pipe section
 - Material
 - Diameter
 - Length
 - Sound velocity

For more detailed information about configuring the pipe sections, please refer to section 3.3 on page 22.

Filter

The **Filter** button displays the following information:

- Correlation curve
- Marker
 - Corresponds to the leak position.

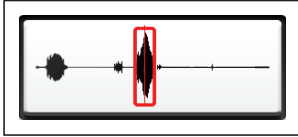

Fig. 13: **Filter** button

The **Filter** menu is opened using the **Filter** button. This menu allows you to optimise the correlation result using filters.

For more detailed information on filters, please refer to section 3.5 on page 31.

Settings

The **Settings** button displays the following information:

- Interference suppression setting
- Number of calculations
- Connected components and information about the charge of the relevant batteries

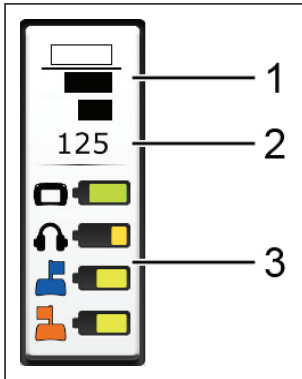

Fig. 14: **Settings** button

- 1 Interference suppression, 2 Calculations
- 3 Components and charge of relevant batteries

The **Settings** menu is opened using the **Settings** button. The following settings can be adjusted in this menu:

- Measurement
- Device

For more detailed information on the **Settings** menu, please refer to section 4 on page 49.

2.2.2.5 How interference suppression works

The interference suppression function allows you to exclude noises from the correlation that may have a negative effect on the result (e.g. sound interference from passing vehicles).

How interference suppression works depends on the settings (**Measurement** menu > **General**).

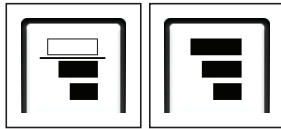

Fig. 15: Interference suppression (detail of **Settings** button)

Left image: Interference suppression on

Right image: Interference suppression off

Whenever interference suppression is active during a measurement, the interference suppression symbol turns red on the **Settings** button.



Fig. 16: Interference suppression active

2.2.3 RT 200 transmitter

The **RT 200** transmitters send the measurement data from the microphones to the **C 200** receiver. The transmitters are always used in pairs.

The two transmitters are marked with a number and a colour to make them distinct.

- Transmitter 1 with blue flag
- Transmitter 2 with orange flag

Note:

The **C 200** receiver uses the same number and colour assignment, e.g. when displaying results.

2.2.3.1 Setup

Overviews with the names of all the parts of the transmitter can be found inside the front cover (fig. 3 to fig. 5).

Ports

The transmitter features the following ports:

- Charging socket
For charging the rechargeable battery.
- Microphone socket
For connecting a microphone.

Filter key



Note:

The **SeCorr** system has filter options for various purposes. An overview of these can be found in section 2.4 on page 20.

The bandpass can be adjusted using the filter key. A bandpass is a filter that only allows signals through from a certain frequency range.

This function can be used to adjust the noise transmission to the current situation. For example, when performing correlation on plastic pipes, the quality of the measurement can be improved if necessary using the **low pass** setting.

The options are:

- **Low pass**  Allows all signals below a limit frequency through. Blocks any signals above the limit frequency.
- **Default**  Allows all signals through.
- **High pass**  Allows all signals above a limit frequency through. Blocks signals below the limit frequency.

There is an LED next to each symbol. The LED of the set band-pass turns green.

The **RT 200** always switches to the **Default** setting when switched on.

Light key

The light key is used to switch the light source of the **UM 200** universal microphone on and off.

LED

The LED indicates the operating status.

Information about what the LED signals mean can be found in section 3.2 on page 22.

Aerial

There is a knob at the top end of the aerial for convenient carrying of the transmitter.

2.2.3.2 Switching the transmitter on and off

Switching on

The transmitter automatically switches on as soon as a microphone is connected.

Switching off

The transmitter automatically switches off as soon as the microphone is disconnected from the transmitter.

For more detailed information about the plug connection between the microphone and the transmitter, please refer to section 2.5 on page 20.

2.2.4 Microphones

The microphones record noises at the measurement locations. This data is then sent to the transmitters via cable.

The system can be used with different microphones. One microphone is required for each **RT 200** transmitter. The same type of microphone must always be used for the two transmitters.

2.2.4.1 UM 200 universal microphone

The **UM 200** is a highly sensitive microphone for picking up structure-borne noise.

The **UM 200** is connected directly to the **RT 200** receiver with a cable.

Accessories can be attached to the **UM 200**. The right accessories can be used to secure the microphone at various measurement locations.

The microphone features a light which can be used to illuminate the measurement location (torch function).



CAUTION! Risk of glare

The light source comprises two powerful LEDs.

- Do not look directly into the light.
 - Never shine the light into the eyes of another person.
-

Contact adapter

The contact adapter is an accessory with which the microphone can be attached directly to the measuring point.



CAUTION!

Danger when using the contact adapter

The contact adapter contains a strong magnet.

- Keep the contact adapter away from magnetic storage media (e.g. hard drives, credit cards) and medical devices (e.g. pacemakers, insulin pumps).
-

The contact adapter is supplied with a short-circuit disc.

- Remove the short-circuit disc before using the contact adapter for the first time.

2.2.4.2 HY 200 hydrophone

The **HY 200** hydrophone records noises directly from the water column.



CAUTION! Risk of contamination

The **HY 200** is designed for use in drinking water networks.

- Always disinfect the **HY 200** before use.
-

2.3 Switching on and off

2.3.1 Receiver

Switching on

- Press the on/off key until the LED turns green.

Switching off

1. Briefly press the ON/OFF key. The **Switch off** dialog will appear.
2. Tap **Switch off device**. The receiver switches off.

2.3.2 Transmitter

Switching on

The transmitter automatically switches on as soon as a microphone is connected.

Switching off

The transmitter automatically switches off as soon as the microphone is disconnected from the transmitter.

For more detailed information about the plug connection between the microphone and the transmitter, please refer to section 2.5 on page 20.

2.4 Filter options (overview)

Filters can be used both on the transmitter and the receiver. Filters are used for different purposes.

- **RT 200** transmitter
 - The bandpass can be adjusted using the filter key (section 2.2.3.1 on page 16).
- **C 200** receiver
 - The correlation result can be optimised using filters (section 3.5 on page 31).
 - A blocking filter can be used to minimise the effects of current-carrying electrical lines on the noise (section 4.3.1.4 on page 54).
 - Date filters can be used to search for specific measurements in the list of saved measurements (section 3.4.3.1 on page 28).

2.5 Plug connection between microphone and RT 200 transmitter

The plug connection is coded. For clarity, the following are each marked with a red dot:

- Plug on microphone cable
- Microphone socket on **RT 200** transmitter

Connecting the microphone

- Align the two red dots with each other. The plug can be inserted into the microphone socket.

Disconnecting

- Pull back the cover on the microphone plug. This will release the connection. The microphone cable can now be removed.

2.6 Power supply to the components

The following components are powered by a special, inbuilt rechargeable lithium-ion battery.

- **C 200** receiver
- **RT 200** transmitter

The **F8** wireless headphones come with a rechargeable NiMh battery.

For information on charging the batteries, please refer to section 5.1 on page 62.

NOTICE! Risk of damage when changing lithium-ion batteries

The battery compartments of the components contain parts that could get damaged when the batteries are being replaced.

- Only SEWERIN service personnel or other authorised specialists may replace rechargeable lithium-ion batteries.
-



WARNING! Risk of explosion due to short-circuit

Faulty lithium-ion rechargeable batteries can explode due to internal short-circuit.

- Components containing a faulty lithium-ion battery must not be shipped.
-

3 Using the system

3.1 Preparing the system

Two suitable measurement locations must be found depending on conditions on the ground. Suitable measurement locations include, for example, fittings or the pipe itself.

1. Attach a microphone to each of the measurement locations.
 - The same microphone type must be used at the two measurement locations.
2. Connect each of the microphones to an **RT 200**. The **RT 200** will switch on automatically.
3. Switch on the **C 200** receiver. The system is ready for use.

3.2 Measurement steps (overview)

Once the system has been prepared, location can begin.

A measurement comprises the following steps:

1. Configuring the pipe sections (section 3.3 on page 22)
2. Starting a measurement (section 3.4.1 on page 26)
3. Stopping a measurement (section 3.4.2 on page 27)
4. Selecting and adjusting filters (optional) (section 3.5.2 on page 34)
5. Saving a measurement (optional) (section 3.4.3 on page 27)

3.3 Configuring the pipe sections

A measuring section can comprise one or more pipe sections. Each pipe section is characterised by its pipe data. New pipe sections are automatically assigned values from the **Pipe data (Default)**.

Note:

The quality of the correlation result depends greatly on the configuration of the pipe sections.

- Make sure you configure the pipe sections completely and correctly in accordance with the conditions on the ground.
 - Adjust the settings before starting the measurement. Any changes made after the start of a measurement will mean that it will not be possible to continue the measurement afterwards.
-

The main view is open.

1. Tap the **Pipe sections** button. The **Pipe sections** menu will appear.

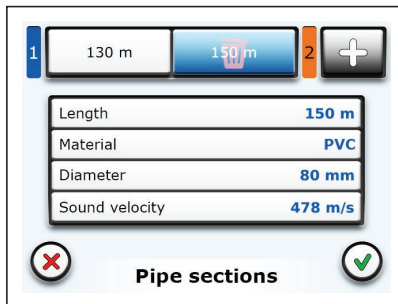

Fig. 17: **Pipe sections** menu

- Top: Diagram of pipe sections, *here*: measuring section with two pipe sections, 2nd pipe section selected (highlighted blue)
- Top right: **Add** button
- Centre: Pipe data from the selected pipe section

2. Set the number of pipe sections (section 3.3.1).
3. Adjust the pipe data for every pipe section (section 3.3.2).

3.3.1 Setting the number of pipe sections

A measuring section consists of:

- at least one pipe section
- a maximum of five pipe sections

3.3.1.1 Adding a pipe section

The first pipe section is set on transmitter 1.

- Up to four more pipe sections can be added between the first pipe section and transmitter 2.
- New pipe sections are added to the right of the selected pipe section.

The **Pipe sections** menu is open.

1. Tap on the pipe section beside which you want to add a new pipe section. The pipe section will be highlighted in blue.
2. Tap on the **Add** button. A new pipe section will be added.

Note:

Adjust the pipe data for the new pipe section (section 3.3.2).

3. Apply the settings by pressing **Confirm**. The receiver will switch back to the main view.

3.3.1.2 Deleting a pipe section

Pipe sections can be deleted.

The last remaining pipe section cannot be deleted. The pipe data for it, however, can be reset to the default values by going through the deletion process.

The **Pipe sections** menu is open.

1. Tap the pipe section to be deleted. The pipe section will be highlighted in blue.
2. Tap the selected pipe section again. The pipe section will be deleted without any further confirmation prompt.
3. Apply the settings by pressing **Confirm**. The receiver will switch back to the main view.

3.3.2 Adjusting the pipe data

Pipe sections are characterised by the following features:

- Length of pipe
- Diameter of pipe
- Pipe material
- Sound velocity in the pipe section

Adjoining pipe sections in a measuring section can have different pipe data.

New pipe sections are automatically assigned values from the **Pipe data (Default)**. The values must then be adjusted according to the conditions on the ground.

For more detailed information about the selection options and value ranges, please refer to section 4.3.3 on page 56.

The **Pipe sections** menu is open.

1. Tap the pipe section for which you want to adjust the pipe data. The pipe section will be highlighted in blue.
2. Adjust the pipe data.
3. Apply the settings by pressing **Confirm**. The receiver will switch back to the main view.

Note:

After a sound velocity measurement (section 3.6.3), the **Sound velocity** symbol is displayed next to the numerical value in the **Pipe sections** menu under **Sound velocity**.

If you manually adjust the preset sound velocity, the **Manual** symbol is displayed next to the numerical value in the **Pipe sections** menu under **Sound velocity**.

3.4 Performing a measurement

Each measurement must be started manually and stopped at a suitable time.

Once a measurement has been stopped, it can be saved, continued or repeated.

3.4.1 Starting a measurement

Note:

The quality of the correlation result also depends on the general noise level at the start of a measurement.

- Wherever possible, try to start a measurement when there is no loud sound interference in the background (e.g. no passing vehicles, extraction from house connections).
-

The main view is open. The **Start measurement** button is visible (fig. 9, image above).

- Tap the **Start measurement** button when the general noise level is suitable. The measurement will start. The **Stop measurement** button will appear.

3.4.1.1 Starting the measurement after configuring pipe sections

Once the pipe sections have been configured, the calculation data must be reset before a new measurement can be started.

The main view is open. The **Start measurement** button is not visible (fig. 9, image below).

1. Tap the **Reset** button. The **Start measurement** button will appear.
2. Tap the **Start measurement** button when the general noise level is suitable. The measurement will start. The **Stop measurement** button will appear.

3.4.1.2 Continuing measurement

Measurements can be continued under the following conditions:

- The measurement has been stopped.
- The pipe sections have not been changed.
- The calculation data has not been **reset**.

To continue the measurement, it must be restarted.

- Tap the **Start measurement** button when the general noise level is suitable. The measurement will start. The **Stop measurement** button will appear.

3.4.1.3 Repeating a measurement

Measurements can be repeated under the following conditions:

- The measurement has been stopped.
- The pipe sections have not been changed.

To repeat a measurement, it must be restarted.

1. Tap the **Reset** button. The **Start measurement** button will appear.
2. Tap the **Start measurement** button when the general noise level is suitable. The measurement will start. The **Stop measurement** button will appear.

3.4.2 Stopping a measurement

Ongoing measurements can be stopped at any time.

In order to achieve a reliable result, SEWERIN recommends: Not stopping the measurement until the marker, leak position and quality of the peak stop changing.

The main view is open. A measurement is ongoing.

- Tap the **Stop measurement** button. The measurement will stop. The **Start measurement** button will appear.

Stopped measurements can be saved or continued.

3.4.3 Saving a measurement

Measurements can be saved. Approximately 70 measurements can be saved.

A message will appear when the memory is full. Measurements can be deleted from the memory to free up space. For information about deleting saved measurements, please refer to section 3.4.3.2 on page 30.

Saved measurements are indicated by:

- Date (day and time measurement was saved)
- Optional: Comment

The main view is open. The measurement was stopped

1. Tap the **File** button. The **File** menu will appear.
2. Tap the **Save** button. The **Comment** menu appears.
3. Measurements can be saved with or without additional information.
 - Tap **Confirm** to save the measurement without additional information.

OR

- a) Enter a comment using the virtual keyboard.

The comment can be up to a maximum of 25 characters long.

- b) Tap **Confirm** to save the measurement with additional information.

The receiver will switch back to the main view.

3.4.3.1 Loading a saved measurement

Saved measurements can be loaded from the memory. Information about the measurement can also be displayed.

Note:

Only one measurement can be loaded at a time.

The main view is open.

1. Tap the **File** button. The **File** menu will appear.
2. Tap the **Load** button. The **Load** menu will appear.

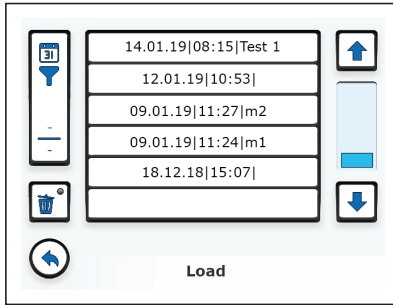

Fig. 18: **Load** menu
 Top left: **Filter by date** button
 Centre: List of saved measurements

3. Tap the relevant measurement in the list. The measurement will immediately appear in the main view.

Searching for saved measurements

Date filters can be set in the list of saved measurements to search for specific measurements.

The following date filters are available:

- Year
- Year and month

The **Load** menu is open.

1. Tap the **Filter by date** button on the top left. The **Filter by date** menu will appear.
2. Set the values for the search.
 - Left field: Year, right field: Month
 - **Any** means that no date filter will be set.
 - Only values that have been saved for the data are available for the search.

Example:

Measurements were saved in 2017 and 2019. No measurements were saved in 2018. The filter criteria available for selection are: Any, 2017, 2019.

3. Apply the filters by pressing **Confirm**. The receiver will switch back to the **Load** menu.

The list will show all the measurements that match the search criteria. The date filter settings are displayed on the **Filter by date**.

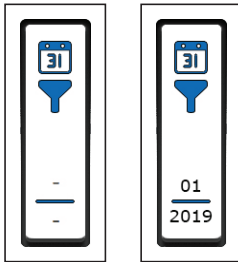

Fig. 19: **Filter by date** button

Left image: No date filter set

Right image: Date filter set (year: 2019, month: 01 January)

3.4.3.2 Deleting a saved measurement

Saved measurements can be deleted individually. To do this delete mode needs to be enabled.

NOTICE! Risk of data loss

In delete mode, measurements are deleted immediately without further prompting.

- Work with extreme care in delete mode.
-

The main view is open.

1. Tap the **File** button. The **File** menu will appear.
2. Tap the **Load** button. The **Load** menu will appear.
3. Tap the **Clear** button. Delete mode is enabled. The dot on the **Clear** button turns red. The measurements in the list appear in red.
4. Tap the measurement you want to delete in the list. The measurement will be deleted immediately without further prompting.

5. Finally, disable delete mode.

- To do this, tap the **Clear** button again. Delete mode is disabled. The dot on the **Clear** button turns grey again. The measurements in the list appear in black.

OR

- Tap **Back**.

3.5 Optimising the correlation result using filters

Note:

The **SeCorr** system has filter options for various purposes. An overview of these can be found in section 2.4 on page 20.

Filters can help optimise the correlation result and thus locate leaks more reliably. Filters are set in the frequency graph.

A well-applied filter will have the following effect on the correlation curve:

- Peaks will be displayed in higher quality, i.e. sharper, with steeper sides, etc.
- The peak of a potential leak noise will be accentuated compared to other noises (e.g. sound interference).

Aim of optimisation

The aim is to obtain the highest quality peak possible in the correlation curve.

3.5.1 Filter menu (overview)

The **Filter** menu displays the frequencies, correlation curve and the result of the measurement as a graph.

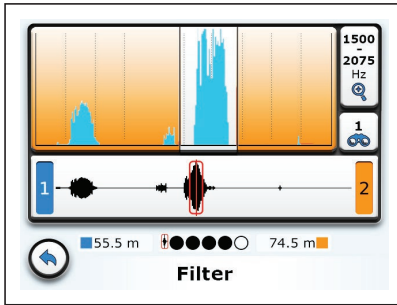

Fig. 20: **Filter** menu

Top: Frequency graph

Centre: Correlation curve



Bottom: Result of measurement and quality of peak

Right (top to bottom): **Lower filter limit,**
Current filter, here: Auto 1

Available filters

Various filters can be applied.

The options are:

- **Auto 1**  Automatically calculated filter 1
- **Auto 2**  Automatically calculated filter 2
- **Manual**  Manually set filter

The symbol of the active filter is displayed on the **Current filter** button.

Manually set filters are saved with a measurement.

3.5.1.1 Frequency graph

The receiver displays the spectra of the noises in the frequency graph.

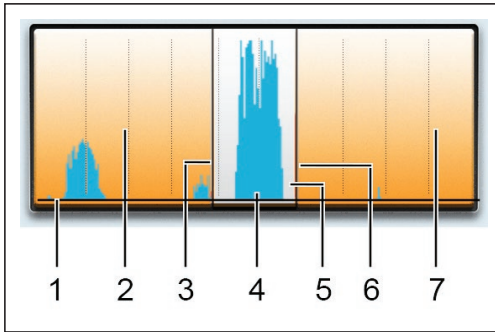

Fig. 21: Frequency graph
1 Frequency axis, 2 Lower stopband, 3 Lower filter limit,
4 Graph of functions, 5 Passband,
6 Upper filter limit, 7 Upper stopband

In the settings you can specify whether to display one or two functions (**Measurement** menu > **Filter basis**).

If two functions are displayed:

- Areas in which the two functions overlap are shown in black.
- If the values of one function are lower than the values of the other function across the whole frequency range, you will only be able to see the function with the higher values and the overlap.

One filter is always set in the frequency graph. This filter can be changed.

- The filter currently applied will be shown on the **Current filter** button.
- The values of the filter limits will be specified on the **Filter limits** buttons.

Dashes will be shown instead of digits if an automatic filter calculates the entire frequency range as the passband.

3.5.1.2 Correlation curve

The run time difference between the signals of the two transmitters is displayed in the correlation curve.



Fig. 22: Correlation curve with marker (red rectangle)

The area around the highest peak of the curve is marked with a red rectangle. This marker indicates the calculated leak position.

If a correlation curve shows several significant peaks, a plausibility check should be carried out (section 3.6).

3.5.1.3 Quality of peak

The sharper or clearer the peak, the better the quality. The quality can be improved by setting filters.

The quality of a peak is rated by dots. The more black dots, the higher the quality.



Fig. 23: Quality of peak
Left image: Very high quality
Right image: Poor quality

Note:

The quality of a peak does not correlate to the accuracy of the calculated leak position.

3.5.2 Selecting and adjusting filters

One filter is always set in the frequency graph when the **Filter** menu is opened. Whether an automatically calculated filter or a manually set filter is applied first depends on the starting point. Once the menu has been opened, you can switch between filters.

Automatic filters are always recalculated when the **Filter** menu is opened.

Opening the filter menu

The main view is open.

- Tap the **Filter** button. The **Filter** menu appears (fig. 20).

Note:

Any ongoing measurements will be stopped when the **Filter** menu is opened.

3.5.2.1 Selecting automatically calculated filters

Note:

Filters **Auto 1** and **Auto 2** are identical if the calculation algorithms on which they are based do not detect any differences.

The **Filter** menu is open.

- Repeatedly tap the **Current filter** button. If the **Auto 1** or **Auto 2** symbol appears, automatically calculated filter 1 or 2 will be applied.

3.5.2.2 Manually adjusting filters

There are two ways of manually adjusting the filter limits:

- Quick adjustment
- Exact adjustment

Performing a quick filter adjustment

A quick adjustment involves resetting both filter limits.

The **Filter** menu is open.

1. Tap the frequency graph (fig. 21).
 - as accurately as possible.

The **Filter** menu will change its appearance (fig. 24). The first filter limit is set.

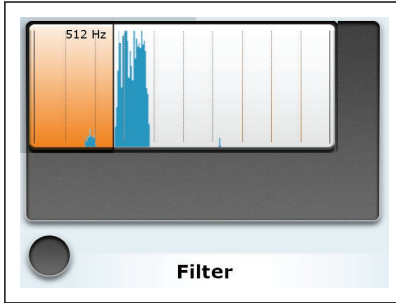

Fig. 24: **Filter** menu: Quick filter adjustment

2. Tap the frequency graph a second time.
 - The higher of the two tapped frequency values will be assigned to the upper filter limit.

The **Filter** menu will return to its default view (fig. 20). The second filter limit is set. The **Manual** symbol is visible on the **Current filter** button.

Performing an exact filter adjustment

When performing an exact adjustment, the upper and lower filter limits are set independently of each other. The filter limits can be moved in very small increments.

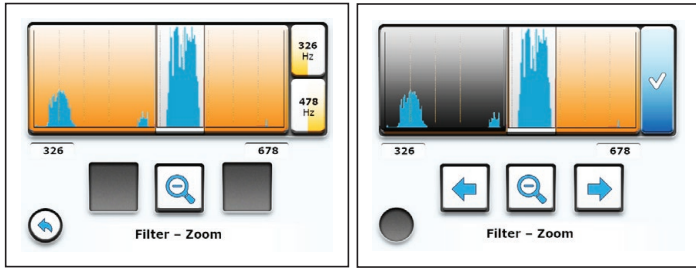

Fig. 25: **Filter – Zoom** menu: Exact filter adjustment
 Left image: With the **Upper filter limit**, **Lower filter limit** (right) and **Zoom** (centre) buttons
 Right image: With the **Confirm** button

The **Filter** menu is open.

1. Tap the **Filter limits** button. The receiver will switch to the **Filter – Zoom** menu (fig. 25, left image).
2. Reset the filter limit. Tap one of the **Upper filter limit** or **Lower filter limit** buttons. The **Filter – Zoom** menu will change its appearance (fig. 25, right image).

The filter limit stop range that can be adjusted is displayed in orange.

- Tap **Zoom**. The display changes immediately.
 - Tap the frequency graph to roughly set the filter limit.
 - Tap one of the **Move** buttons to define the filter limit exactly.
3. Apply the setting by pressing **Confirm**. The receiver will switch back to the previous view.
 4. If necessary, repeat all the steps for the other filter limit.
 5. Tap **Back**. The receiver will return to the **Filter** menu. The **Manual** symbol is visible on the **Current filter** button (see fig. 26).

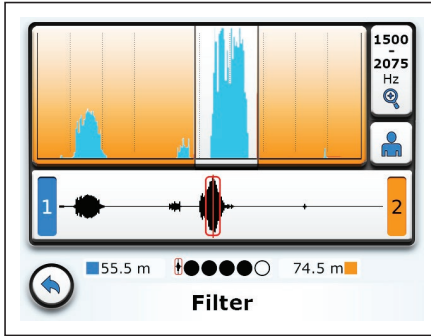

Fig. 26: **Filter** menu: After manual adjustment, the **Manual** symbol appears under the **Filter limits** button.

3.5.2.3 Applying the filters (exiting the Filter menu)

The settings can be applied once the filter limits have been adjusted.

The **Filter** menu is open.

- Tap **Back**. The filter settings will now be applied. The receiver will switch back to the main view.

3.6 Plausibility check

The correlator cannot determine whether there is an actual leak at a calculated position or whether the noise is interference (e.g. open house connection).

This can pose a problem if the correlation curve shows more than one significant peak. In such cases, we recommend checking the plausibility of the correlation result.

The following options are available for checking the plausibility:

- Moving the marker
- Hide peak
- Sound velocity measurement

3.6.1 Moving the marker

Correlation curves can show several significant peaks. The position of another noise source is calculated by moving the marker.

The **Filter** menu is open.

1. Tap the correlation curve. The receiver will switch to the **Correlation** menu (fig. 27).
2. Place the marker on another peak. Tap the desired position in the correlation curve.
3. Read the newly calculated position.
4. Check the conditions on the ground.
 - Is there another noise source at the calculated location?

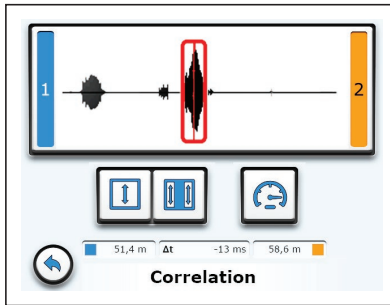

Fig. 27: **Correlation** menu

Top: Correlation curve

Below (from left): **Show peak**, **Hide peak**, **Sound velocity** buttons

Bottom: Display of leak position and run time difference Δt

5. Tap **Back**. The receiver will switch to the **Filter** menu. The newly set marker is applied to the correlation curve.

3.6.2 Hide peak

Noise from sources of interference can overlap leak noise. The peak of an interference noise can be faded out in a targeted manner.

The **Filter** menu is open.

1. Tap the correlation curve. The receiver will switch to the **Correlation** menu (fig. 27).
2. Tap the **Hide peak** button.

3. Select the area you want to hide.
 - a) Tap the correlation curve to set the first limit.
 - b) Tap the correlation curve again to set the second limit.
 The hidden area is displayed in orange.
 4. Tap **Back**. The settings are applied. The receiver will switch to the **Filter** menu. The correlation curve shows the hidden area.
- Hidden peaks can be shown again at any time.
- Tap the **Show peak** button in the **Correlation** menu. The selected area is deleted. The selected peak is visible again.

3.6.3 Sound velocity measurement

The sound velocity depends to a large degree on the pipe data (length, diameter, material). The receiver has default values for the sound velocity which are used to calculate the leak position.

In practice, there may be deviations from the known or assumed pipe data on a measuring section. These deviations can have a significant effect on the accuracy of the measurement. This applies in particular to leaks that are not located in the middle of the measuring section. A sound velocity measurement is recommended in such cases.

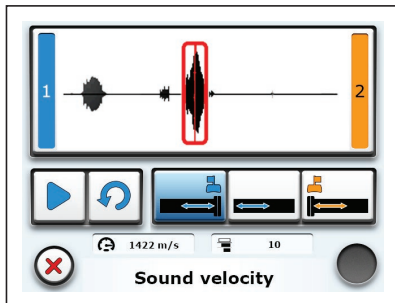

Fig. 28: **Sound velocity** menu
 Top: Correlation curve
 Below (from left): **Start measurement, Reset, Outside 1, Between the transmitters, Outside 2** buttons
 Bottom: Measured sound velocity, number of calculations

3.6.3.1 Artificial leak outside of the measuring section

In the ideal case, it is possible to generate an artificial leak outside of the measuring section.

1. Generate an artificial leak (e.g. open hydrant) outside of the measuring section.

Open the **Filter** menu on the device.

2. Tap the correlation curve. The **Correlation** menu appears.
3. Tap the **Sound velocity** button. The **Sound velocity** menu will appear.
4. Specify whether the artificial leak is outside transmitter 1 or outside transmitter 2. Tap the corresponding button.
5. Tap the **Start measurement** button. The measurement will start. The **Stop measurement** button will appear.
6. Stop the measurement when the current value for the measured sound velocity has stabilised.
7. Apply the measured sound velocity by pressing **Confirm**.

The sound velocity measurement is complete. The receiver will switch back to the **Correlation** menu. The measured sound velocity is applied to the current measurement.

3.6.3.2 Artificial leak within the measuring section

In certain cases it is not possible to generate an artificial leak outside of the measuring section. The sound velocity can also be measured using an artificial leak within the measuring section.

1. Open the **Sound velocity** menu.
2. Tap the **Between the transmitters** button. The dialog **Distance (from 1) [m]** appears.
3. Enter the distance of the artificial leak from transmitter 1.
4. Confirm the entry. The receiver will switch back to the **Sound velocity** menu.
5. Tap the **Start measurement** button. The measurement will start. The **Stop measurement** button will appear.

6. Stop the measurement when the current value for the measured sound velocity has stabilised.
7. Apply the measured sound velocity by pressing **Confirm**.

The sound velocity measurement is complete. The receiver will switch back to the **Correlation** menu. The measured sound velocity is applied to the current measurement.

3.7 Listening to noises

Note:

F8 wireless headphones are required for listening to noises.

3.7.1 Information about the radio connection during listening

The **C 200** receiver and **F8** wireless headphones communicate by bidirectional SDR (SDR: Sewerin Digital Radio).

SDR transmits uncompressed signals in real time. Radio interference can, therefore, cause a short clicking noise in the headphones.

SDR uses the same frequency ranges as, for example, WLAN or Bluetooth. In rare cases, SDR can, therefore, be affected by other radio connections.

These effects can be minimised by the following measures:

- Avoid drops in the SDR radio connection caused by obstructions, e.g. your own body. Carry the receiver in such a way that the transmission path to the headphones is not obscured.
- If you are carrying electronic devices that use WLAN and Bluetooth directly on your body: Disable the WLAN and Bluetooth function if necessary.

3.7.2 Transmitter menu (overview)

The **Transmitter** menu displays information about the transmitters connected by radio.

The following noise settings can be adjusted:

- Volume on the headphones
- Transmitter selection

The microphone function can be opened if a microphone is connected to the receiver.

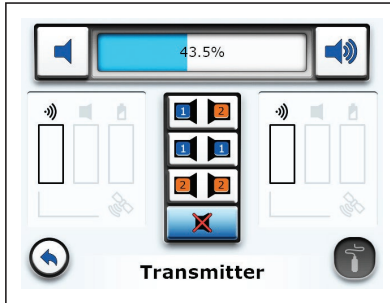

Fig. 29: **Transmitter** menu without a connected transmitter

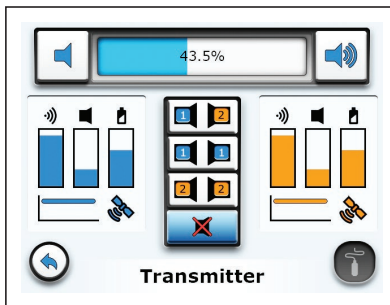

Fig. 30: **Transmitter** menu with connected transmitters

Top: Volume
 Centre: Transmitter selection
 Left/right: Information about transmitter 1/2

Information about the transmitters

The following information appears as soon as an **RT 200** transmitter is connected:

- Strength of radio signal at receiver
- Current noise level at transmitter
- Battery charge

- Bandpass setting
- Satellite reception

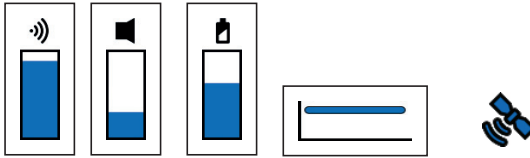

Fig. 31: Information about the transmitter, *here*: Transmitter 1
From left to right: Radio signal, noise level, rechargeable battery, bandpass, satellite reception

Note:

The information is not constantly updated as radio transmission of the noise takes precedence. It can sometimes take up to 20s for changes to be displayed.

3.7.3 Adjusting the volume

The volume determines how loudly the noises are played back through the headphones.



CAUTION! Health hazard

Excessive noise can damage hearing and lead to irreversible damage to health.

- Always adjust the volume to the current situation.
 - Choose as low a volume as possible.
-

The main view is open.

1. Tap the **Transmitter** button. The **Transmitter** menu will appear.
2. Adjust the volume. To do this, tap on either:
 - the **volume** symbols
 - in the area between the two **volume** symbols

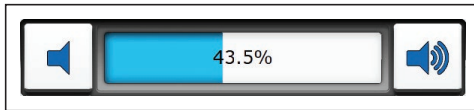

Fig. 32: Adjusting the volume





3. Apply the settings by pressing **Confirm**. The receiver will switch back to the main view.

The settings are stored until they are next adjusted.

3.7.4 Selecting a transmitter

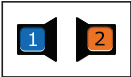
The noises from the two measuring points can be listened to together or separately.

The options are:

- Noises from transmitters 1 and 2 
- Noises from transmitter 1 
- Noises from transmitter 2 
- No noise 

The main view is open.

1. Tap the **Transmitter** button. The **Transmitter** menu will appear.
2. Tap the relevant transmitter selection. The setting is applied immediately.

The setting is stored until it is next adjusted.

3.8 Microphone function for acoustic leak detection

The microphone function is an extra function on the **C 200** receiver.

The microphone function can be used to listen to noises directly at a measurement location. It can be used when there is no suitable technology available specifically for pinpointing or prelocation.

Note:

The microphone function cannot be used for correlation.

The following system components are required for acoustic leak detection:

- **C 200** receiver
- Microphone, e.g. **UM 200** universal microphone
- **F8** wireless headphones

3.8.1 Microphone menu (overview)

A measurement to listen to noises can be performed in the **Microphone** menu. The results of the measurement are displayed in a graph and as numerical values.

Note:

The **Microphone** menu can only be opened when a microphone is connected to the receiver.

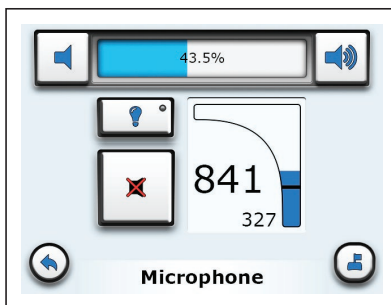

Fig. 33: **Microphone** menu

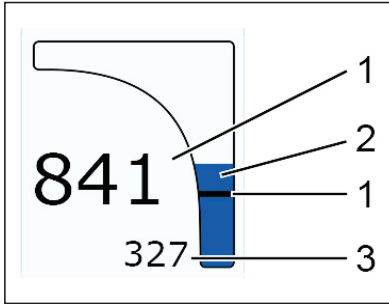

Fig. 34: Display of measurement values (detail of **Microphone** menu)

- 1 Current minimum noise level
- 2 Current noise level
- 3 Previous minimum noise level

The following measurement values are displayed (fig. 34):

- Current noise level
- Current minimum noise level
- Previous minimum noise level

The **Microphone** menu also contains the following buttons:

- **Volume**
- **Light**
- **Listen to microphone**
- **Turn off noise**

The volume for the microphone function (**Microphone** menu) is independent of the volume for listening to noises (**Transmitter** menu). The volume must be set separately in the two menus. The setting procedure is identical.

The **Light** key can be used to switch the microphone's light source on and off.

3.8.2 Performing a noise measurement

The current noise level is always displayed in the **Microphone** menu. However, the noises can only be heard once a measurement has started.

The receiver is switched on. The main view is open.

1. Connect a microphone (e.g. **UM 200**) to the microphone socket on the receiver.
2. Attach the microphone to a suitable measurement location.
3. Tap the **Transmitter** button. The **Transmitter** menu will appear. The **Microphone** button can be seen at the bottom right.
Which microphone symbol appears on the **Microphone** button depends on the microphone connected.
4. Tap the **Microphone** button. The **Microphone** menu will appear.
5. Tap the **Listen to microphone** button to start a measurement.
6. Adjust the volume to the current situation.
 - Proceed as explained in section 3.7.3 on page 44.
 - Please note the health hazard warning in the same section.
7. Tap the **Switch noise off** button when you want to stop the measurement.

Exiting the Microphone menu

- To return to the **Transmitter** menu, tap the **Transmitter** button.
- To return to the main view, tap **Back**.

3.9 Locking and unlocking the display

The display can be locked against unintentional operation.

Locking

1. Briefly press the ON/OFF key. The receiver switches to the **Switching off** menu for 3 seconds.
2. Tap **Lock display**. The display switches off immediately.

Unlocking

- Briefly press the **ON/OFF key** again. The receiver displays the **Switching off** menu. The display changes to the last view shown after 3 seconds.

4 Settings

4.1 Overview

All settings are managed using the **C 200** receiver. The settings can be changed at any time. The following menus are available:

- **Measurement**
- **Device**

4.2 Setting actions

The settings in the **Measurement** and **Device** menus are implemented as follows:

- Select
- Enable/disable
- Set value

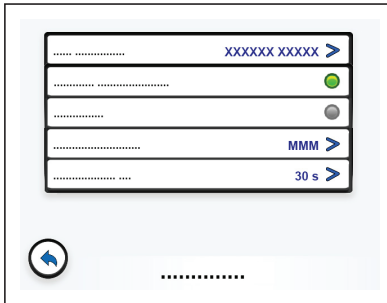

Fig. 35: Menu (sample diagram)

- Very top: Menu item with selected settings
- Below: Menu items with enabled/disabled settings
- Bottom: Menu items with set values

Menu items in which settings can be selected or values set are indicated by the **next** symbol.

Menu items in which settings can be enabled/disabled are marked with a check box (dot).

4.2.1 Selecting

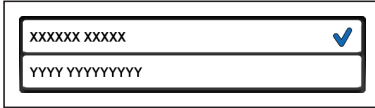

Fig. 36: Selecting a setting (sample diagram)

Top: Setting selected
Bottom: Setting not selected

Selected settings are indicated by the **tick** symbol.

1. In one of the menus, tap on the menu item for which you wish to change the setting.

A sub-menu will appear.

2. Tap the relevant setting.

The setting is applied immediately without further confirmation. The receiver goes back up a menu level.

The selected setting is displayed in the higher menu level.

4.2.2 Enabling/disabling

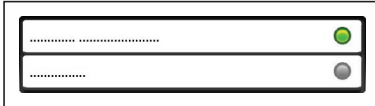

Fig. 37: Enabling/disabling a setting (sample diagram)

Top: Setting enabled
Bottom: Setting disabled

Enabled settings are indicated by a green check box. Disabled settings have a grey check box.

- In one of the menus, tap on the menu item you wish to enable or disable.

The setting is applied and displayed immediately without further confirmation.

4.2.3 Setting a value

Values are set either via a picklist or a numeric keypad.

Picklist

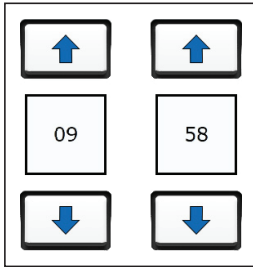

Fig. 38: Picklist

Values are set using the arrow keys.

1. Tap an arrow key.
 - The up key increases the value.
 - The down key decreases the value.
2. Apply the settings by pressing **Confirm**.
The receiver goes back up a menu level.

Numeric keypad

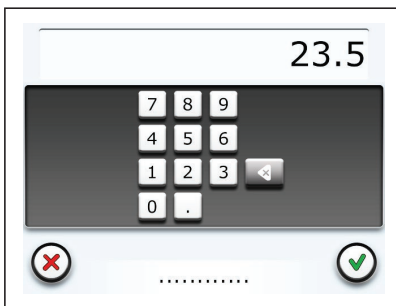

Fig. 39: Numeric keypad

1. Tap the relevant number keys. The selected numbers will be displayed via the numeric keypad.
2. Apply the value by pressing **Confirm**.
The value is rounded up or down if it is outside the value range or has an invalid number of decimal places.
The receiver goes back up a menu level.

4.3 Settings in the Measurement menu

The settings in the **Measurement** menu apply to the measurements.

General	
Units >	Metric Anglo-American
Interference suppression >	high low Off
Correlation curve >	Positive Positive & negative
Blocking filter >	60 Hz 50 Hz Off
Filter basis	
Coherence >	blue red Off
Cross spectrum >	blue red Off
Spectrum 1 >	blue red Off
Spectrum 2 >	blue red Off
Sound velocity >	blue red Off
Pipe data (Default)	
Length >	...
Material >	AC Copper ...
Diameter >	...
Sound velocity >	...

Fig. 40: **Measurement** menu

The main view is open.

1. Tap the **Settings** button. The **Settings** menu appears.
2. Tap the **Measurement** button. The **Measurement** menu appears.
3. Adjust the settings as required.

The **Measurement** menu is divided into three views **General**, **Filter basis** and **Pipe data (Default)**.

Switch between the views using the **Scroll** buttons.

The settings options are explained in the next sections.

4. Finally, tap **Back**. The **Settings** menu appears.
5. Tap **Back** again to return to the main view.

4.3.1 General

4.3.1.1 Units

Different units can be used for specifying the pipe data.

The options are:

- **Metric**

Length specified in metres (m) and diameter specified in millimetres (mm).

- **Anglo-American**

Length specified in feet (ft.) and diameter specified in inches (in.).

4.3.1.2 Interference suppression

Excessive noise can be suppressed to varying degrees

The options are:

- **On**

Interference suppression is enabled. Some slightly quieter noises may be excluded from the correlation.

- **Off**

Interference suppression is disabled.

4.3.1.3 Correlation curve

The correlation curve can be displayed in different ways.

The options are:

- **Positive**

Displays the magnitude of the positive and negative values. The correlation curve is above the x-axis.

- **Positive and negative**

Displays both positive and negative values. The correlation curve oscillates around the x-axis.

4.3.1.4 Blocking filter

The blocking filter is an electronic filter which filters out the mains frequency of the power supply. This minimises the impact of current-carrying electrical lines on the noise.

The options are:

- **60 Hz | 50 Hz**

Mains frequency that can be selected.

- **Off**

The blocking filter is disabled.

4.3.2 Filter basis

The noises can be displayed as a graph based on different functions in the **Filter** menu.

The options are:

- **Coherence**

- **Cross spectrum**

- **Spectrum 1**

- **Spectrum 2**

- **Sound velocity**

Up to a maximum of two functions can be displayed at the same time.

4.3.2.1 Coherence

Coherence of noises transmitted by transmitters 1 and 2 to the receiver.

The options are:

- **Blue | Red**

Colour that can be selected for the graph.

- **Off**

The function is not displayed.

4.3.2.2 Cross spectrum

Cross power spectrum of noises transmitted from transmitters 1 and 2 to the receiver.

The options are:

- **Blue | Red**

Colour that can be selected for the graph.

- **Off**

The function is not displayed.

4.3.2.3 Spectrum 1 or Spectrum 2

Auto-power spectrum of the noises transmitted from transmitter 1 or transmitter 2 to the receiver.

The options are:

- **Blue | Red**

Colour that can be selected for the graph.

- **Off**

The function is not displayed.

4.3.2.4 Sound velocity

The options are:

- **Blue | Red**

Colour that can be selected for the graph.

- **Off**

The function is not displayed.

4.3.3 Pipe data (Default)

The default values, which are automatically assigned to each new pipe section created, are set in the **Pipe data (Default)** view.

SEWERIN recommends: When selecting default settings, choose typical values that commonly occur in your everyday work. For example, if you primarily work on cast iron pipes, set the material to cast iron.

4.3.3.1 Length

Indicates the length of a pipe section.

- Value range: 0.5 m – 3000 m
- Decimal places: 1

4.3.3.2 Material

Indicates the material of the pipe in the pipe section.

There is a wide range of materials available for selection.

4.3.3.3 Diameter

Indicates the diameter of the pipe in the pipe section.

- Value range: 10 mm – 3000 mm
- Decimal places: None

4.3.3.4 Sound velocity

The sound velocity is automatically calculated by the device from the diameter and the pipe material.

The calculated value can be changed. This change is saved temporarily. However, as soon as other settings are selected for the diameter or the material, the sound velocity is recalculated.

- Value range: 220 m/s – 2000 m/s
- Decimal places: None

4.4 Settings in the Device menu

The settings in the **Device** menu apply to the receiver.

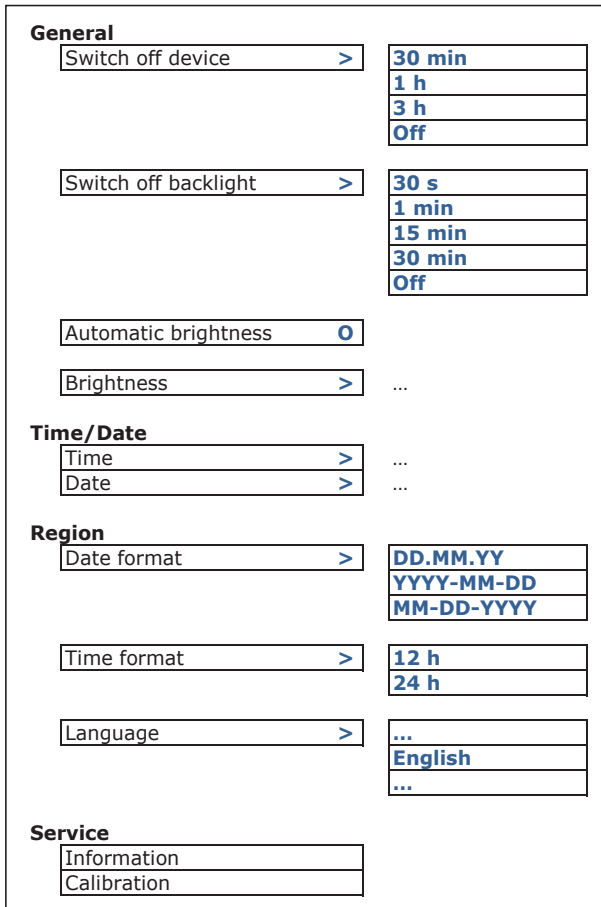

Fig. 41: **Device** menu

The main view is open.

1. Tap the **Settings** button. The **Settings** menu appears.
2. Tap the **Device** button. The **Device** menu appears.
3. Adjust the settings as required.

The **Device** menu is divided into the four views **General**, **Time/Date**, **Region** and **Service**.

– Switch between the views using the **Scroll** buttons.

The settings options are explained in the next sections.

4. Finally, tap **Back**. The **Device** menu appears.
5. Tap **Back** again to return to the main view.

4.4.1 General

4.4.1.1 Switching off the device

The receiver can switch off automatically if it is not operated for a specified period of time.

Note:

This function helps save energy. It means that the receiver can be used for longer without being recharged.

The options are:

- **30 min | 1 h | 3 h**

Duration that can be selected.

- **Off**

The receiver does not switch itself off.

4.4.1.2 Switching off the backlight

The touch screen backlight can switch off automatically if it is not operated for a specified period of time. The receiver remains switched on.

Note:

This function helps save energy. It means that the receiver can be used for longer without being recharged.

The options are:

- **30 s | 1 min | 15 min | 30 min**

Duration that can be selected.

- **Off**

The backlight does not switch itself off.

4.4.1.3 Automatic brightness

The brightness of the touch screen can automatically adjust to the ambient lighting conditions thanks to the light sensor. This means that the touch screen is clearly legible in every situation.

This function can be enabled or disabled.

- When this function is disabled, you can set the brightness manually.

4.4.1.4 Brightness

Note:

Brightness only appears in the menu when the **Automatic brightness** function is disabled.

When the **Automatic brightness** function is disabled, a permanent value can be set for the brightness of the touch screen.

4.4.2 Time/Date

4.4.2.1 Time

The receiver features an internal clock. The time is used to identify the measurements.

Note:

The format of the time can be set under **Time format** in the menu.

4.4.2.2 Date

The date is used to identify the measurements.

Note:

The format of the date can be set under **Date format** in the menu.

4.4.3 Region

4.4.3.1 Date format

The date can be written in various ways. The options are:

- **DD.MM.YY**
- **YYYY-MM-DD**
- **MM-DD-YYYY**

The letters refer to the following:

D: day

M: month

Y: Year

4.4.3.2 Time format

The time can be written in various ways.

The options are:

- **12 h**
12 hour clock
- **24 h**
24 hour clock

4.4.3.3 Language

The text on the user interface can be displayed in various languages.

There is a range of languages to choose from.

4.4.4 Service

4.4.4.1 Information

The relevant current technical information is stored in each receiver.

The following information will be displayed:

- Firmware version number
- Hardware version number

4.4.4.2 Calibration

The touch screen can be calibrated by the user.

For more detailed information on calibration, please refer to section 5.3 on page 67.

5 Maintenance

5.1 Charging the batteries

The batteries for the following components must be recharged when necessary:

- **C 200** receiver (lithium-ion rechargeable battery)
- **RT 200** transmitter (lithium-ion rechargeable battery)
- **F8** wireless headphones (NiMH rechargeable battery)

The typical charging time is less than 7.5 hours. The batteries are protected against overcharging. The components can, therefore, remain connected to the power supply after they are fully charged.

Always observe the permitted temperature range during charging. If the temperature falls below or exceeds the limit values, charging stops until the temperature returns to within the permitted range.

There are two ways of charging the components:

- All components at the same time in the **AC 200 SK 4** case
- Each component individually using the AC/DC adapter or vehicle cable

5.1.1 Charging the batteries in the case

The batteries of the components can all be charged simultaneously in the **AC 200 SK 4** case. The case is connected to the power supply using AC/DC adapter **L** or vehicle cable **L**.

The AC/DC adapter and the vehicle cable are available to buy as accessories.

The connection cable for the components can be found in the case. There is a connection socket on the outside of the case for connecting to the power supply.



Fig. 42: **AC 200 SK 4** case
White circles: Connection cable
Black arrow: Connection socket (on the outside)

1. Place the components in the dedicated spaces in the case.
 2. Connect the components using the connection cables.
 3. Connect the case to the power supply using the AC/DC adapter **L** or vehicle cable **L**. Charging starts automatically.
- After less than 7.5 hours the charging process is complete.

5.1.2 **Charging batteries using the AC/DC adapter or vehicle cable**

The components are connected directly to the power supply for charging using AC/DC adapter **M4** or vehicle cable **M4**. Each component is charged individually.

The AC/DC adapter and the vehicle cable are available to buy as accessories.

When the battery is fully charged, the LED on the **C 200** receiver and **RT 200** transmitters emits a double flash (green).

5.2 Handling faulty lithium-ion rechargeable batteries

Lithium-ion batteries are always classed as dangerous goods for transport purposes.

The transportation of faulty lithium-ion batteries is only permitted under certain conditions (e.g. must not be transported as air freight). Where transportation is permitted (e.g. by road or rail), it is subject to strict regulations. Faulty lithium-ion batteries must, therefore, always be removed from components before shipping. Transportation by road or rail must occur in compliance with the current applicable version of the ADR regulations ¹.

NOTICE! Risk of damage when removing lithium-ion rechargeable batteries

When opening the housing, the components can be damaged mechanically or by electrostatic discharge.

- Lithium-ion batteries must only be removed if there is reasonable suspicion that they might be faulty.
 - Only SEWERIN Service personnel or an authorised specialist may replace rechargeable batteries.
-

5.2.1 Identifying faulty batteries

A lithium-ion battery is considered to be faulty if one of the following criteria applies²:

- Housing damaged or badly deformed
- Liquid leaking from battery
- Smell of gas from battery
- Rise in temperature with the receiver switched off (more than hand-hot)
- Plastic parts melted or deformed
- Connection leads melted

¹ French abbreviation for: Accord européen relatif au transport international des marchandises dangereuses par route, Engl.: European Agreement concerning the International Carriage of Dangerous Goods by Road

² According to: EPTA – European Power Tool Association

5.2.2 Removing the batteries from the C 200 receiver

NOTICE! Risk of damage

There are parts in the battery compartment of the receiver which can be damaged mechanically or by electrostatic discharge when removing the batteries.

- Always read section 5.2 and section 5.2.1.
 - Avoid electrostatic discharges at all costs, e.g. by using an ESD workstation.
-



Fig. 43: Back of the **C 200** receiver
White circles: Screws of the battery compartment cover

The batteries are in the battery compartment. The battery compartment is sealed with the battery compartment cover.

The receiver must be switched off.

1. Undo the four screws securing the battery compartment cover.
 2. Lift off the battery compartment cover with extreme care.
-

NOTICE! Risk of damage

There is an aerial in the battery compartment cover. That is why the battery compartment cover has an electrical connection (cable) from the inside into the device interior.

- Please ensure that the cable does not get severed.
 - Never touch the solder joint on the inside of the battery compartment cover.
-

3. Disconnect the electrical supply to the faulty battery by pulling off the white plug.
Never sever the cable.
4. Remove the battery.
5. Screw the battery compartment cover back on.

5.2.3 Removing the battery from the RT 200 transmitter

The battery is located inside the device.

NOTICE! Risk of damage

When opening the housing, the transmitter can be damaged mechanically or by electrostatic discharge.

- It is essential to read section 5.2 and section 5.2.1 before removing the battery.
 - Avoid electrostatic discharges at all costs, e.g. by using an ESD workstation.
-

There should be no microphone connected to the transmitter.

1. Undo the four screws on the bottom section of the housing.
2. Carefully lift off the bottom section of the housing.
The top section and the bottom section of the housing are connected by means of the cable from the battery to the circuit board.
3. Disconnect the electrical supply to the faulty battery by unplugging the white connector on the circuit board.
Do not under any circumstances rip out the cable.
4. The battery is fixed in place in the bottom section of the housing by means of a retaining plate. Loosen the three screws on the retaining plate.
5. Remove the battery.
6. Screw down the retaining plate again.
7. Screw the bottom section of the housing to the top section again.

5.3 Calibrating the touch screen

The touch screen of the **C 200** receiver is calibrated when it leaves the factory. If the touch screen responds incorrectly when operated, it can be recalibrated.

Calibration involves two stages, which occur automatically in succession. Firstly the areas are reset. Then the reset areas need to be confirmed.

Note:

If the calibration process is interrupted, the touch screen may be so misaligned that it cannot be used.

- Never switch the receiver off during the calibration process.
 - Always use a touch pen for calibration.
 - Work with extreme care.
-

The main view is open.

1. Tap the **Settings** button. The **Settings** menu appears.
2. Tap the **Device** button. The **Device** menu appears.
3. Switch to the **Service** view (**Device 4/4**).
4. Tap **Calibration**. The calibration begins.
5. Follow the instructions.
 - The individual steps must be completed within a limited time. If the time limit is exceeded, the calibration process will be aborted.
 - The active area is marked with crosshairs. Non-active areas are grey.
 - **Blue** crosshairs: Set area
 - **Red** crosshairs: Confirm area
 - Try to hit the centre of the active area as accurately as possible.

Once the screen has been successfully calibrated, the receiver automatically switches back to the **Service** view.

5.4 Care

All that is necessary to care for the components is to wipe them down with a damp cloth.

SEWERIN recommends: Always remove significant contamination immediately.

5.5 Maintenance

SEWERIN recommends: Have the system serviced regularly by SEWERIN Service or an authorised professional. Only regular servicing can ensure that the system is always ready for use.

6 Appendix

6.1 Technical data

6.1.1 C 200 receiver

Device data

Dimensions (W x D x H)	225 x 62 x 155 mm
Weight	1.2 kg
Material	polycarbonate (housing)

Certificates

Certificate	FCC, CE, IC, MIC
Marking	Contains: FCC ID WSP-EZ1300102 IC 7994A-EZ1300102

Features

Display	5.7" TFT display, 640 x 480 pixels (VGA), LED backlight
Interface	micro USB
Memory	90 MB (internal)
Processor	RISC 32-bit, DSP
Operation	Touch screen, ON/OFF key

Operating conditions

Operating temperature	-20 – 60 °C
Storage temperature	-25 – 50 °C (briefly +60 °C)
Humidity	15 – 90 % r.h., non-condensing
Protection rating	IP65/IP67
Non-permitted operating environments	in potentially explosive areas

Power supply

Power supply	2 x lithium-ion batteries (rechargeable) [1357-0002]
Operating time, typical	> 10 h
Battery power	2 x 24 Wh
Charging time	< 7.5 h
Charging temperature	0 – 40 °C
Charging voltage	12 V
Charging current	1.2 A
Charger	AC/DC adapter L (charge in case)

Data logging

Filter	automatic or manual
Sampling rate	16 bit, 24 kHz

Data transmission

	Near-field radio	SDR (Sewerin Digital Radio)
Transmission frequency	433.9/434.4 MHz 444.5500/444.9875 MHz 458.5125 /458.7875 MHz 468.5/469.6 MHz	2.408 – 2.476 GHz, 38 channels
Radio range	> 500 m	> 2 m
Transmission bandwidth	0 – 5 kHz	0 – 12 kHz
Power	500 mW	10 mW

Additional data

Attachment option	Quick-release fastener
Transport	Case AC 200 SK4, case SK10
Shipping instructions	UN 3481: lithium-ion batteries contained in equipment or lithium-ion batteries packed with equipment net weight of battery/batteries: 0.196 kg

6.1.2 RT 200 transmitter

Device data

Dimensions (W x D x H)	115 × 115 × 68 mm 115 × 115 × 244 mm with aerial
Weight	430 g (with aerial)
Material	polycarbonate (housing)
Models	country-specific

Certificates

Certificate	FCC, CE, IC
Marking	– everywhere apart from USA: Contains: 70TX-D2 – USA only: Contains: 70TX-D, FCC-ID:PUX70TX-D

Features

Signal light	1 LED red/green for operating status 3 LEDs green for filter
Interface	internal (USB)
Processor	DSP, 16 bit / 120 MHz
Operation	membrane keypad

Operating conditions

Operating temperature	-20 – 60 °C
Storage temperature	-25 – 50 °C (briefly 60 °C)
Humidity	15 – 90 % r.h. non-condensing
Protection rating	IP65 IP67 with aerial
Non-permitted operating environments	in potentially explosive areas

Power supply

Power supply	lithium-ion battery (rechargeable) [1357-0002], built-in
Operating time, minimum	> 8 h (23 °C)
Battery power	24 Wh
Charging time	< 6 h
Charging temperature	0 – 45 °C
Charging voltage	12 V
Charging current	1.2 A
Charger	AC/DC adapter L (charge in case)

Measurement

Filter	– 3 bandpasses: 0 – 500 Hz, 0 – 4000 Hz, 200 – 4000 Hz – Notch filter
Sampling rate	16 bit, 48 kHz
Measurement ranges	0 – 1 Vrms
Sensitivity	automatic amplification: 163 levels (-17.25 – 89 dB)

Data transmission

Transmission frequency	international: 433.9/434.4 MHz France: 444.5500/444.9875 MHz UK: 458.5125/458.7875 MHz USA: 468.5/469.6 MHz
Radio range	> 500 m
Transmission bandwidth	5 kHz 0 – 4 kHz: NF 4 – 5 kHz: Control signals
Communication	analogue
Power	500 mW

Positioning GNSS (GPS, Galileo, GLONASS)

Accuracy	2.5 m CEP, 50 %
Aerial	integrated

Additional data

Shipping instructions	UN 3481: lithium-ion batteries contained in equipment or lithium-ion batteries packed with equipment net weight of battery/batteries: 0.098 kg
-----------------------	---

6.1.3 UM 200 universal microphone

Device data

Dimensions (H × Ø)	123 x 45 mm (without cable)
Weight	1055 g
Material	stainless steel
Models	3 cable lengths available

Features

Signal light	2 LEDs white (each 15 cd)
--------------	---------------------------

Operating conditions

Operating temperature	-20 – 80 °C
Storage temperature	-25 – 80 °C
Protection rating	IP68
Non-permitted operating environments	in aggressive media in potentially explosive areas

Measurement

Measurement principle	piezo microphone (analogue)
Sensitivity	approx. 10 V/g (20 – 1000 Hz)

Additional data

Cable type	6-pin, outer diameter 6.2 mm, tensile strength > 3000 N
Cable length	1.3 m / 2.8 m / 6 m

6.1.4 HY 200 hydrophone

Device data

Dimensions (W × H)	55 x 115 mm
Weight	700 g (without cable)
Material	stainless steel

Operating conditions

Operating temperature	-20 – 80 °C
Storage temperature	-25 – 80 °C
Atmospheric pressure	water pressure up to 16 bar
Protection rating	IP68
Non-permitted operating environments	in liquids other than water In aggressive media in potentially explosive areas

Power supply

Power supply	via RT 200
--------------	------------

Measurement

Filter	20 Hz high pass
Measurement principle	piezo microphone (analogue)

Data transmission

Communication	analogue via cable with RT 200
---------------	--------------------------------













Additional data













Cable type	6-pin, outer diameter 6.2 mm
Cable length	2.9 m















6.2 Symbols on the touch screen of the C 200 receiver

















The following tables provide an overview of what the main symbols represent. The symbols can also occur in combination during the program sequence. Many symbols on the touch screen can be displayed in different ways:

- Coloured symbol
Function enabled, system component connected, etc.
- Symbol greyed out
Function disabled, system component not connected, etc.

Symbol	Significance
	Confirm
	Cancel
	Back
	Scroll
	Receiver
	Transmitter
	Universal microphone
	Microphone unknown
	Headphones
	Measurement settings
	Device settings
	Start measurement
	Stop measurement

Symbol	Significance
	Reset
	Add
	Interference suppression
	Quality of peak
	Duration of measurement
	Rechargeable battery
	Battery fully charged
	Battery flat
	Battery charging
	Auto 1
	Auto 2
	Manual
	Volume

Symbol	Significance
	Volume low
	Volume high
	Brightness
	Brightness low
	Brightness high
	Light on microphone
	File
	Charge
	Filter by date
	Save
	Delete
	Selected
	Next
	Move
	Zoom

Symbol	Significance
	Noises from transmitter
	Noises from transmitter 1
	Noises from transmitter 2
	No noises from transmitter
	Listen to microphone
	Signal strength
	Satellite reception
	No satellite reception
	Crosshairs
	Settings Application
	Sound velocity
	Hide peak
	Show peak
	Outside 1
	Between the transmitters
	Outside 2

6.3 Significance of LED signals

6.3.1 C 200 receiver

The LED indicates the operating status.

Colour	Type of signal	Activation (repeat)	Significance
Green	Light permanently on		● C 200 switched on
	Flashing	0.1 s on > 0.9 s off (ongoing)	● Battery charging
	Double flash	0.1 s on > 0.1 s off > 0.1 s on > 0.7 s off (ongoing)	● Battery is fully charged
Red	Light permanently on		● C 200 switched on ● Undervoltage: Battery needs charging
	Flashing	0.1 s on > 0.9 s off (ongoing)	● Error when charging battery (temperature below or above permitted charging temperature)

6.3.2 RT 200 transmitter

The large LED between the two keys indicates operating statuses (see table below).

The three small LEDs above the filter key indicate the bandpass setting.

Colour	Type of signal	Activation (repeat)	Significance
Green	Light permanently on		<ul style="list-style-type: none"> ● RT 200 switched on
	Flashing	0.1 s on > 0.9 s off (ongoing)	<ul style="list-style-type: none"> ● Battery charging
	Double flash	0.1 s on > 0.1 s off > 0.1 s on > 0.7 s off (ongoing)	<ul style="list-style-type: none"> ● Battery is fully charged
Red	Light permanently on		<ul style="list-style-type: none"> ● RT 200 switched on ● Undervoltage: Battery needs charging
	Flashing	0.1 s on > 0.9 s off (ongoing)	<ul style="list-style-type: none"> ● Error when charging battery (temperature below or above permitted charging temperature)

6.4 Troubleshooting

Problems with the receiver

Problem	Possible cause	Corrective action
Touch screen black	Backlight has switched off after specified time	<ul style="list-style-type: none">● Touch the screen > display will light up again● If necessary change backlight time (setting: Switch off backlight)
	Battery flat	<ul style="list-style-type: none">● Recharge battery
	Touch screen or receiver faulty	<ul style="list-style-type: none">● Contact SEWERIN Service

6.5 Accessories

Part	Order number
F8 wireless headphones	EZ13-18000
HY 200 hydrophone (set)	HY20-S0001
UM 200 microphone protector	EM20-Z0201
M10 tripod	4000-0966
Triangle 200 carrying strap	3209-0022
Lap belt carrying system	EA20-Z1000
Padded hand loop	3209-0017
AC/DC adapter L 12 V=	LD26-10000
Vehicle cable L 12 V =	ZL05-10200

Other accessories are available for the system. Please contact our SEWERIN sales department for further information.

6.6 Declaration of conformity

Hermann Sewerin GmbH hereby declares that the **C 200** receiver and **RT 200** transmitter fulfil the requirements of the following directive:

- 2014/53/EU

The complete declaration of conformity can be found online.

6.7 Licences in the EEA

The **RT 200** transmitter may only be used in the following countries of the European Economic Area (EEA) and only at the corresponding frequencies.

Note:

Also refer to the advice regarding near-field radio in section 1.5 on page 4.

Austria	433.9000/434.4000 MHz
Belgium	455.8100/456.1500 MHz
Cyprus	433.9000/434.4000 MHz
Czech Republic	433.9000/434.4000 MHz
Denmark	433.9000/434.4000 MHz
Estonia	433.9000/434.4000 MHz
Finland	433.9000/434.4000 MHz
France	444.5500/444.9875 MHz
Germany	433.9000/434.4000 MHz
Greece	433.9000/434.4000 MHz
Hungary	433.9000/434.4000 MHz
Iceland	433.9000/434.4000 MHz
Ireland	433.9000/434.4000 MHz
Italy	433.9000/434.4000 MHz
Liechtenstein	433.9000/434.4000 MHz
Lithuania	433.9000/434.4000 MHz
Luxembourg	433.9000/434.4000 MHz
Netherlands	433.9000/434.4000 MHz
Norway	433.9000/434.4000 MHz
Poland	433.9000/434.4000 MHz
Romania	433.9000/434.4000 MHz
Spain	433.9000/434.4000 MHz
Sweden	433.9000/434.4000 MHz
Switzerland	433.9000/434.4000 MHz
UK	458.5125/458.7875 MHz

6.8 Note about the firmware (open source software)

The firmware is based on open source software. The source code is provided in accordance with the licence terms for this open source software (GPL / LGPL). Sewerin GmbH stresses that it is not responsible for the source code and it does not form part of the services due.

The source code is available on request at cost price by emailing info@sewerin.com.

The full licence terms can be found online www.sewerin.com.

6.9 Advice on disposal

The European Waste Catalogue (EWC) governs the disposal of appliances and accessories in accordance with EU Directive 2014/955/EU.

Description of waste	Allocated EWC waste code
Device	16 02 13
Disposable battery, rechargeable battery	16 06 05 / 20 01 34

Alternatively, used equipment can be returned to Hermann Sewerin GmbH.

7 Index

A

Acoustic leak detection 45
Aerial 17
Auto 1 / Auto 2 32
Automatic power off 9

B

Bandpass 16
Blocking filter 54
Brightness 59
 automatic 59

C

Calculations, number of 14
Calibration 61, 67
Coherence 55
Communication 4
Correlation curve 34
 display 54
Cross spectrum 55
Current filter (button) 32

D

Data transmission 4
Date 59
Date format 60
Diameter 56

F

Filter
 adjusting 35
 applying 38
 blocking filter 54
 button 13
 date 29
 opening menu 35
 options on the receiver 31
 overview 20
 selecting 35
 transmitter options 16
Frequency graph 33

H

High pass 17
Hydrophone 19

I

Information 60
Interference suppression
 active 15
 operating principle 15

L

Language 60
LED 7, 17
 significance 77
Length 56
License 80
Light key 17
Light sensor 7
Listening to noise 42
Lithium-ion rechargeable battery
 charging 62
 identifying a fault 64
 removing 65, 66
 transport regulations 64
Lock/unlock display 48
Low pass 17

M

Main view 9
Manual 32
Marker 12
 moving 38
Material 56
Measurement
 after configuring pipe sections 26
 charging 28
 continuing 26
 deleting 30
 filtering 29
 measurement steps (overview) 22
 noises 47
 preparing 22
 repeating 27
 saving 27

- starting 26
- stopping 27

Microphone

- connecting 21

Microphone function 45

Minimum noise level 47

N

Near-field radio 4

Noise level 47

Noise measurement 47

P

Peak 34

- hide 39
- quality 34

Pipe data

- adjusting 25

Pipe section

- adding 24
- configuring 22
- deleting 24
- number 23

R

Radio connection

- overview 4
- when listening 42

Receiver 6

- carrying the system 8
- connectors 8
- ports 8
- switching off 9
- switch off backlight 9

Result

- display 10
- optimising 31

S

SDR (Sewerin Digital Radio) 4

Select 50

Settings

- button 14
- device 56
- enable/disable 50
- measurement 52
- options 49
- select 50
- set value 50

Set value 50

Sound velocity

- measuring 40
- setting 56

Spectrum 1 or Spectrum 2 55

Switch off backlight 58

Switch off device 58

Symbols 75

System

- components (overview) 5
- preparing 22

T

Time 59

Time format 60

Touch screen 6

- calibration 67

Transmitter 15

- ports 16
- selecting 45
- switching off 17
- switching on 17

U

Units 53

Universal microphone 18

V

Volume 44, 47



Hermann Sewerin GmbH

Robert-Bosch-Straße 3
33334 Gütersloh, Germany
Tel.: +49 5241 934-0
Fax: +49 5241 934-444
www.sewerin.com
info@sewerin.com

SEWERIN IBERIA S.L.

Centro de Negocios Eisenhower
Avenida Sur del Aeropuerto
de Barajas 28, Planta 2
28042 Madrid, España
Tel.: +34 91 74807-57
Fax: +34 91 74807-58
www.sewerin.com
info@sewerin.es

Sewerin Sp. z o.o.

ul. Twórcza 79L/1
03-289 Warszawa, Polska
Tel.: +48 22 675 09 69
Tel. kom.: +48 501 879 444
www.sewerin.com
info@sewerin.pl

SEWERIN SARL

17, rue Ampère – BP 211
67727 Hoerdt Cedex, France
Tél. : +33 3 88 68 15 15
Fax : +33 3 88 68 11 77
www.sewerin.fr
sewerin@sewerin.fr

Sewerin Portugal, Lda

Rua Sr. Dos Milagres, 16, 2º Esq
3800-261 Aveiro, Portugal
Tlf.: +351 234 133 740
Fax.: +351 234 024 446
www.sewerin.com
info@sewerin.pt

Sewerin Ltd.

Hertfordshire
UK
Phone: +44 1462-634363
www.sewerin.co.uk
info@sewerin.co.uk