



HT9020

User manual



Table of contents:

1. PRECAUTIONS AND SAFETY MEASURES	2
1.1. Preliminary instructions	2
1.2. During use	3
1.3. After use	3
1.4. Definition of measurement (overvoltage) category	3
2. GENERAL DESCRIPTION	4
2.1. Measuring average values and TRMS values	4
2.2. Definition of true root mean square value and crest factor	4
3. PREPARATION FOR USE	5
3.1. Initial checks	5
3.2. Instrument power supply	5
3.3. Calibration	5
3.4. Storage	5
4. OPERATING INSTRUCTIONS	6
4.1. Instrument description	6
4.1.1. Description of the controls	6
4.1.2. Alignment marks	6
4.1.3. Hand protection	7
4.1.4. Indication of the conventional direction of Current	7
4.2. Function keys description	8
4.2.1. F1, F2, F3, F4/OK keys	8
4.2.2. H/ESC/☹ key	8
4.3. Initial screen	8
5. OPERATING INSTRUCTIONS	9
5.1. Instrument settings	9
5.2. AC Voltage detection	9
5.3. DC Voltage measurement	10
5.4. AC/AC + DC Voltage measurement	12
5.4.1. Voltage Harmonics measurement	14
5.4.2. Phase Sequence and Phase Conformity	15
5.5. DC Current measurement	19
5.6. AC/AC + DC Current measurement	21
5.6.1. Current Harmonics measurement	23
5.6.2. Dynamic Inrush current measurement	24
5.7. DC Power and Energy measurement	26
5.8. AC/AC+DC Power and Energy measurement	30
5.9. Resistance and Continuity test measurement	36
6. MAINTENANCE	39
6.1. General information	39
6.2. Battery replacement	39
6.3. Cleaning the instrument	39
6.4. End of life	39
7. TECHNICAL SPECIFICATIONS	40
7.1. Technical characteristics	40
7.1.1. Reference guidelines	42
7.1.2. General characteristics	42
7.2. ENVIRONMENT	42
7.2.1. Environmental conditions for use	42
7.3. Accessories provided	42
8. SERVICE	43
8.1. Warranty conditions	43
8.2. Service	43
9. APPENDIX – THEORETICAL OUTLINE	44
9.1. Calculation of powers in “AC 1P” mode	44
9.2. Calculation of powers in “AC 3P” mode	44
9.3. Calculation of powers in “DC” mode	44
9.4. voltage and current harmonics	45
9.5. Limit values for harmonics	46
9.6. Causes FOR the presence of harmonics	46

1. PRECAUTIONS AND SAFETY MEASURES

The instrument has been designed in compliance with directive IEC/EN61010-1 relative to electronic measuring instruments. For your safety and in order to avoid damaging the instrument, please carefully follow the procedures described in this manual and read all notes preceded by the symbol  paying the utmost attention.

Before and after carrying out measurements, carefully observe the following instructions:

- Do not carry out any voltage or current measurement in humid environments
- Do not carry out any measurement in case of gas, explosive and inflammable materials or dusty environments
- Avoid contact with the circuit under test if no measurement is carried out
- Avoid contact with exposed metal parts, with unused measuring probes, circuits, etc.
- Do not carry out any measurement in case of instrument's anomalies such as deformation, breaks, substance leaks, absence of displayed screen, etc.
- Pay special attention when measuring voltages higher than 20V, since a risk of electrical shock exists

The following symbols are used in this manual and on the instrument:



CAUTION: observe the instructions given in this manual; an improper use could damage the instrument or its components.



High voltage danger: electrical shock hazard.



Double-insulated meter



AC voltage or current



DC voltage or current



Connection to earth

1.1. PRELIMINARY INSTRUCTIONS

- This clamp has been designed for use in environments of pollution degree 2.
- It can be used for **CURRENT** and **VOLTAGE** measurements on installations with measurement category CAT IV 600V and CAT III 1000V. For a definition of measurement categories, see § 1.4.
- We recommend to follow the standard safety rules devised by the procedures for carrying out operations on live systems and using the prescribed PPE to protect the user against dangerous currents and the instrument against incorrect use.
- Only the leads supplied with the instrument guarantee compliance with the safety standards. They must be under good conditions and replaced with identical models, when necessary.
- Do not test circuits exceeding the specified current and voltage limits.
- Check that the battery is correctly inserted.
- Before connecting the test leads to the circuit under test, make sure that the switch is correctly set.
- Make sure that the LCD display and the switch indicate the same function.

1.2. DURING USE

Please carefully read the following recommendations and instructions:



CAUTION

Failure to comply with the Caution notes and/or Instructions may damage the instrument and/or its components or be a source of danger for the operator.

- Before activating the switch, remove the conductor from the clamp jaw or disconnect the test leads from the circuit under test.
- When the instrument is connected to the circuit, do not touch any unused terminal.
- Keep your hands always under the hand protection. This protection is always located in a suitable position to guarantee a correct safety distance from possible exposed or live parts (see Fig. 3)
- Avoid measuring resistance if external voltages are present. Even if the instrument is protected, excessive voltage could cause a malfunction of the clamp.
- During current measurement, any other current near the clamp may affect measurement accuracy.
- When measuring current, always put the conductor as close as possible to the middle of the clamp jaw, to obtain the most accurate reading.
- While measuring, if the value or the sign of the quantity under test remain unchanged, check if the HOLD function is enabled.

1.3. AFTER USE

- When measurement is complete, switch **OFF** the instrument.
- If the instrument is not to be used for a long time, remove the batteries

1.4. DEFINITION OF MEASUREMENT (OVERVOLTAGE) CATEGORY

Standard IEC/EN61010-1: "Safety requirements for electrical equipment for measurement, control and laboratory use, Part 1: General requirements" defines measurement category, commonly called overvoltage category. In § 6.7.4: Measured circuits, circuits are divided into the following measurement categories:

(OMISSIS)

- **Measurement category IV** is for measurements performed at the source of the low-voltage installation.

Examples are electricity meters and measurements on primary overcurrent protection devices and ripple control units.

- **Measurement category III** is for measurements performed on installations inside buildings.

Examples are measurements on distribution boards, circuit breakers, wiring, including cables, bus-bars, junction boxes, switches, socket-outlets in the fixed installation, and equipment for industrial use and some other equipment, for example, stationary motors with permanent connection to fixed installations.

- **Measurement category II** is for measurements performed on circuits directly connected to the low-voltage installation.

Examples are measurements on household appliances, portable tools and similar equipment.

- **Measurement category I** is for measurements performed on circuits not directly connected to MAINS.

Examples are measurements on circuits not derived from MAINS, and specially protected (internal) MAINS-derived circuits. In the latter case, transient stresses are variable; for that reason, the standard requires that the transient withstand capability of the equipment is made known to the user.

2. GENERAL DESCRIPTION

The HT9020 instrument carries out the following measurements:

- DC and AC+DC TRMS voltage
- DC and AC+CD TRMS current
- Phase sequence and conformity test
- AC powers and power factor on single-phase and/or balanced three phase systems
- AC energies on single-phase and/or balanced three-phase systems
- DC power
- AC voltage harmonics up to 25° order and THD%
- AC current harmonics up to 25° order and THD%
- Frequency on voltage (with test leads) and current (with clamp jaw)
- Resistance and continuity test
- Electric motor starting currents (Dynamic Inrush)
- Detection of AC voltage with and without contact with built-in sensor

Each of these functions can be selected using the 6-position selector switch, including OFF position. Keys **F1**, **F2**, **F3**, **F4/OK** and **H / ESC /**  are also provided. For their use, please refer to § 4.2.

2.1. MEASURING AVERAGE VALUES AND TRMS VALUES

Measuring instruments of alternating quantities are divided into two big families:

- AVERAGE-VALUE meters: instruments measuring the value of the single wave signals
- TRMS (True Root Mean Square) VALUE meters: instruments measuring the TRMS value of the quantity being tested

In the presence of a perfectly sinusoidal wave, both families of instruments provide identical results. In the presence of distorted waves, on the other hand, the readings shall differ. Average-value meters provide the RMS value of the sole fundamental wave, TRSM meters, instead, provide the RMS value of the whole wave, including harmonics (within the instrument's bandwidth)

2.2. DEFINITION OF TRUE ROOT MEAN SQUARE VALUE AND CREST FACTOR

The root mean square value of current is defined as follows: "*In a time equal to a period, an alternating current with a root mean square value of the intensity of 1A, circulating on a resistor, dissipates the same energy as that which would have been dissipated by a direct current with the intensity of 1 A during the same time*". This definition results in the numeric expression:

$$G = \sqrt{\frac{1}{T} \int_{t_0}^{t_0+T} g^2(t) dt}$$

The *root mean square value* is indicated with the acronym RMS. The

Crest Factor is defined as the relationship between the Peak Value of a signal and its RMS value: $CF (G) = \frac{G_p}{G_{RMS}}$ This value changes with the signal waveform, for a purely sinusoidal

wave it is $\sqrt{2} = 1.41$. In case of distortion, the Crest Factor takes higher values as wave distortion increases.

3. PREPARATION FOR USE

3.1. INITIAL CHECKS

Before shipping, the instrument has been checked from an electric as well as mechanical point of view. All possible precautions have been taken so that the instrument is delivered undamaged.

However, we recommend generally checking the instrument in order to detect possible damage suffered during transport. In case anomalies are found, immediately contact the forwarding agent.

We also recommend to check whether the package contains all components indicated in § 7.3. In case of discrepancy, please contact the Dealer.

In case the instrument should be replaced, please carefully follow the instructions given in chapter 8.2.

3.2. INSTRUMENT POWER SUPPLY

The instrument is supplied by 2x1.5V LR03 AAA batteries. Replace them following the instructions in § 5.2.

3.3. CALIBRATION

The instrument has the technical specifications described in this manual. The instrument's performance is guaranteed for one year.

3.4. STORAGE

In order to guarantee accurate measurements, after a long storage time under extreme environmental conditions, wait for the instrument to come back to normal condition (see § 7.2.1)

4. OPERATING INSTRUCTIONS

4.1. INSTRUMENT DESCRIPTION

4.1.1. Description of the controls

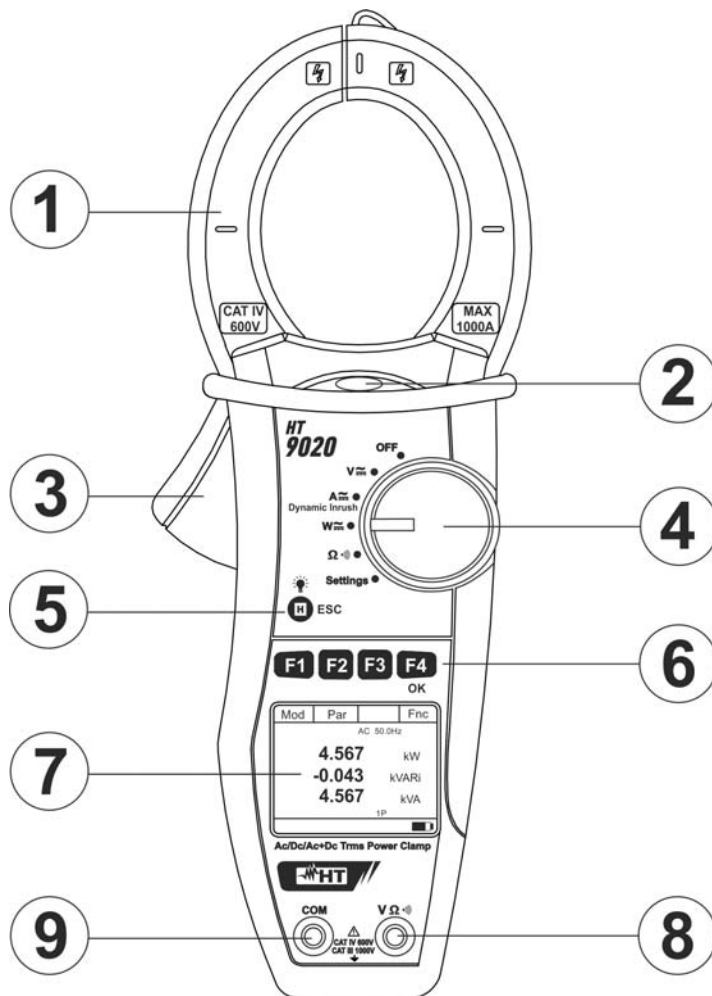

CAPTION:

1. Inductive clamp jaw
2. AC voltage indicator LED
3. Jaw trigger
4. Rotary selector switch
5. **H/ESC** key
6. **F1,F2,F3,F4/OK** function keys
7. LCD display
8. Input terminal **VΩ**
9. Input terminal **COM**

Fig. 1: Instrument description

4.1.2. Alignment marks

Put the conductor as close as possible to the middle of the jaws on the intersection of the indicated marks (see Fig. 2) in order to meet the meter accuracy specifications.

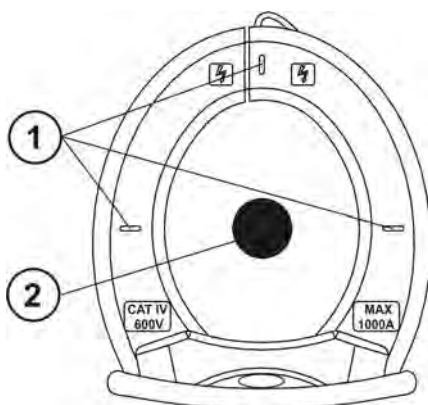

CAPTION:

1. Alignment marks
2. Conductor

Fig. 2: Alignment marks

4.1.3. Hand protection

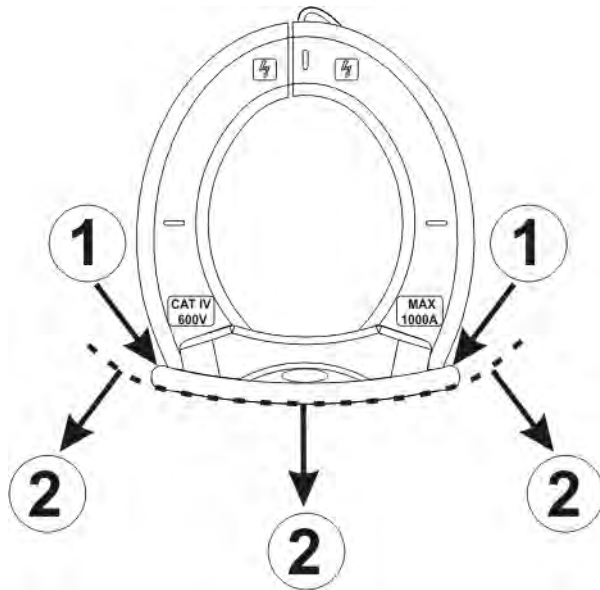

CAPTION:

1. Hand protection
2. Safe area

Fig. 3: hand protection

Always keep your hands under the hand protection. This protection is always located in a suitable position to guarantee a correct safety distance from possible exposed or live parts (see Fig. 3)

4.1.4. Indication of the conventional direction of Current

The Fig. 4 shows an arrow which indicates the conventional direction of current

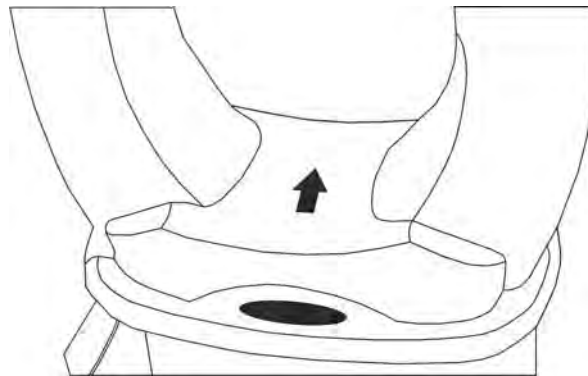



Fig. 4: Current direction arrow

4.2. FUNCTION KEYS DESCRIPTION

4.2.1. F1, F2, F3, F4/OK keys

The **F1**, **F2**, **F3**, **F4/OK** keys perform different functions according to the measurement set (for detailed information, see the single functions).

4.2.2. H/ESC/ key

A single press activates the Data HOLD function and the value of the measurement quantity is frozen at display. The symbol " is displayed when this function is enabled. This operating mode is disabled when "H" key is pressed again or the switch is operated.

To improve the readability of the values measured in dark places, the display has been provided with a backlight function which is turned on and off by long-pressing "H" key. If the feature is set in MAN mode (see § 5.1) the backlight deactivates after approximately 30 seconds after its activation, in order to save battery life.

The same key identify the **ESC** (Exit) functionality inside the different modes of the instrument.

4.3. INITIAL SCREEN

When switching on the instrument, the initial screen appears for a few seconds. It shows:

- The instrument's model
- The instrument's serial number
- The instrument's firmware version

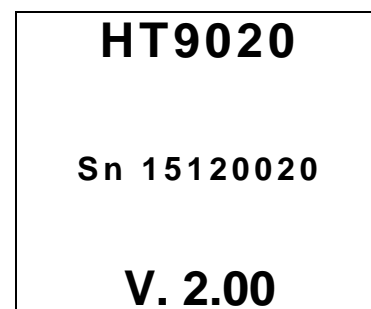

CAUTION

Please note down this information, especially the firmware version, in case it should be necessary to contact the service department.

After a few seconds, the instrument switches to the selected function.

5. OPERATING INSTRUCTIONS

5.1. INSTRUMENT SETTINGS

By positioning the selector switch to “**Settings**”, the screen aside will appear, containing the possible settings of the instrument.

Press **F1 (Sel)** key to see the different selections. Press **F2, F3** (◀, ▶) keys to modify the settings of the selected items and **F4 (OK)** key to confirm the selections.

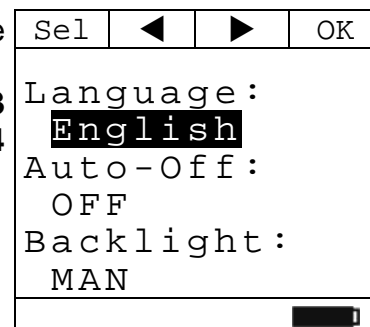

Language

In the “**Language**” section it is possible to set the system language. Press **F2, F3** (◀, ▶) keys for the selection of the available languages and **F4 (OK)** key to confirm the selected item. The “Saved data” message is displayed for a while in the bottom part of display.

Auto - Off

In the “**Auto - Off**” section it is possible to activate/deactivate the auto power off feature. Press **F2, F3** (◀, ▶) keys for the selection of the “ON” or “OFF” options and **F4 (OK)** key to confirm the selected item. The “Saved data” message is displayed for a while in the bottom part of display.

The “**Ⓞ**” symbol is displayed with auto power off feature activated and the instrument switches off after approx.. 5 minutes of idleness.

Backlight

In the “**Backlight**” section it is possible to select the activation mode of display backlight. Press **F2, F3** (◀, ▶) keys for the selection of the “MAN” option (backlight manually activated by pressing “**H**” key and disable after approx. 30 seconds) or “ON” (backlight always active) and **F4 (OK)** key to confirm the selected item. The “Saved data” message is displayed for a while in the bottom part of display.

The “ON” option can result a significant reduction of the battery life.

5.2. AC VOLTAGE DETECTION

With the selector switch set to “**V_~**” by taking the end of the clamp jaw near an AC source, the red LED at the base of the clamp jaw will turn on (see Fig. 1 – part 2), which indicates that voltage is present.



CAUTION

Phase detection is active only when the clamp selector switch is set to “**V_~**” position

5.3. DC VOLTAGE MEASUREMENT



CAUTION

The maximum DC or AC+DC input voltage is 1000V. When the display shows “> 999.9V”, it means that the maximum value that clamp is capable of measuring has been exceeded. Exceeding these limits could result in electrical shocks to the user and damage to the instrument.



Fig. 5: DC Voltage measurement

1. By positioning the selector switch to “V_{DC}”, the screen aside will appear

Mod	Har	Fnc	
	AC	< 42.5	Hz
	---		V

2. Press **F1 (Mod)** key to open the drop-down menu shown on the screen nearby and select the “DC” option with the same key
3. Press the **F4 (OK)** to confirm

Mod	Har	Fnc	OK
AC		< 42.5	Hz
DC			
Ph Seq			
Help		---	V

4. Connect red cable to input lead **VΩ⁽¹⁾**) and black cable to input lead **COM** then position the leads at the desired points of the circuit under test (see Fig. 5)
5. The screen shows an example of DC Voltage measurement.

Mod		Fnc	
	DC		
	9.1	V	
█			

6. Press **F3 (Fnc)** key to open the drop-down menu shown on the screen nearby. At each subsequent pressure of **F3** key, the cursor will scroll through the available items, as follows:

- **Max**: it constantly displays the maximum value of the measured DC Voltage
- **Min**: it constantly displays the minimum value of the measured DC Voltage
- **Cr+**: it constantly displays the maximum positive crest value
- **Cr-**: it constantly displays the minimum negative crest value
- **RST**: (RESET) it deletes all stored Max, Min, Cr+ and Cr- values and re-start with a new measure
- **ESC**: it goes back from **Max/Min/Cr+/Cr-** and return to normal measuring mode

Mod		Fnc	OK
	DC	Max	
	9.	Min	V
		Cr+	
		Cr-	
		RST	
		Esc	
█			

7. By pressing **F4 (OK)**, the selected item is confirmed. Nearby an example of measurement with active Max function. The "Max" symbol indicates the active function

Mod		Fnc	
Max	DC		
	12.0	V	
█			

8. For the use of HOLD and backlight feature see § 5.1



CAUTION

The measurement of the 4 Max, Min, Cr+ and Cr- values is simultaneous, regardless of the displayed value.

5.4. AC/AC + DC VOLTAGE MEASUREMENT



CAUTION

The maximum AC/AC+DC input voltage is 1000V. When the display shows “> 999.9V”, it means that the maximum value which clamp is capable of measuring has been exceeded. Exceeding these limits could result in electrical shocks to the user and damage to the instrument.



Fig. 6: AC/AC + DC voltage measurement

1. By positioning the selector switch to “V_~”, the screen nearby will appear

Mod	Har	Fnc	
	AC	< 42.5	Hz
	---		V
[Battery Icon]			

2. Press **F1 (Mod)** to open the drop-down menu shown on the screen aside and select the “AC” option with the same key
3. Press **F4 (OK)** to confirm

Mod	Har	Fnc	OK
AC		< 42.5	Hz
DC			
Ph Seq			
Help		---	V
[Battery Icon]			

4. Connect red cable to input lead **VΩ⁽¹⁾**) and black cable to input lead **COM** then position the leads to the desired points of the circuit under test (see Fig. 6)

5. The screen shows an example of AC voltage measurement. The instrument allows the evaluation of possible DC components overlapped on a generic alternate waveform (AC+DC) signal and this can be very useful for the measurements on impulsive signals typically of no-linear loads (e.g: welders, electric ovens, etc)

Mod	Har	Fnc	
	AC	50.0	Hz
230.1			V

6. Press **F3 (Fnc)** to open the drop-down menu shown on the screen aside. At each subsequent pressure of key **F3**, the cursor will scroll through the available items, as follows:

- **Max**: it constantly displays the maximum value of the measured AC+DC Voltage
- **Min**: it constantly displays the minimum value of the measured AC+DC Voltage
- **Cr+**: it constantly displays the maximum positive crest value
- **Cr-**: it constantly displays the minimum negative crest value
- **RST**: (RESET) it deletes all stored Max, Min, Cr+ and Cr- values and re-start with a new measure
- **Esc**: it goes back from **Max/Min/Cr+/Cr-** and return to normal measuring mode

Mod	Har	Fnc	OK
	AC	Max	
		Min	
		Cr+	
		Cr-	
	2	RST	V
		Esc	



CAUTION

Note: the measurement of the 4 Max, Min, Cr+ and Cr- values is simultaneous, regardless of the displayed value.

7. By pressing **F4 (OK)**, the selected item is confirmed. Nearby, an example of measurement with active Max function.

Mod	Har	Fnc	
Max	AC	50.0	Hz
231.5			V

8. For the use of HOLD and backlight features see § 5.1

5.4.1. Voltage Harmonics measurement

1. Press **F2 (Har)** key to select the screen of voltage harmonics as shown nearby. Press again **F2 (RMS)** to go back to voltage measurement screen

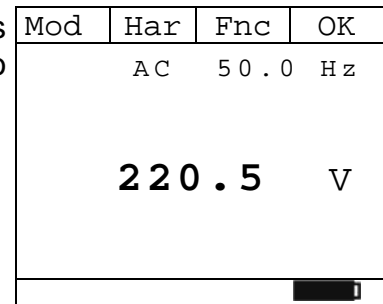

2. By pressing **F1 (◀)** or **F4 (▶)**, it is possible to move the cursor over the graph and select the harmonic to be measured. The correspondent absolute or percentage value of harmonic voltage is shown. It is possible to measure up to the 25th harmonic

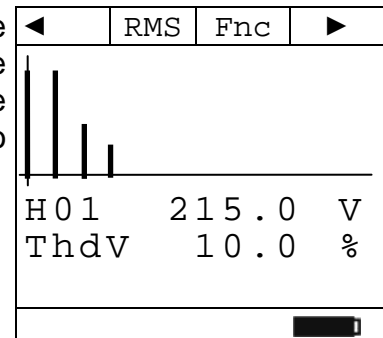

3. While measuring Voltage Harmonics, press **F3 (Fnc)** to open the drop-down menu shown on the screen aside. At each subsequent pressure of **F3**, the cursor will scroll through the available items, as follows:

- **Max**: it constantly displays the maximum RMS value of the selected current harmonic
- **Min**: it constantly displays the minimum RMS value of the selected current harmonic
- **Abs**: it displays the absolute value of the harmonics in Volts
- **%**: it displays the value of the harmonics as percentage value with respect to the fundamental
- **RST (RESET)** it deletes all stored Max, Min values and re-start with a new measure
- **Esc**: it goes back to a normal measuring mode

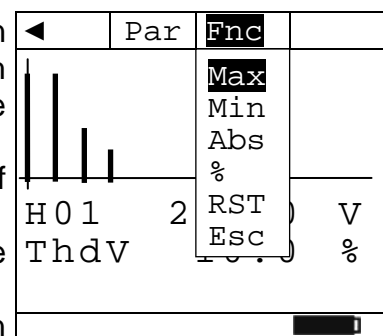

CAUTION

Since the menu contains functions with a different meaning (Max-Min and Abs-%), it is necessary to enter the menu twice: first for displaying Abs or % values and second time to enable the Max or Min functions

4. By pressing **F4 (OK)**, the selected item is confirmed. Nearby, an example of measurement with active Max function. The display shows the active function.

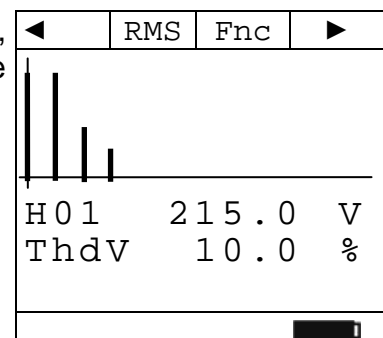

5. For the use of HOLD and backlight features see § 5.1

5.4.2. Phase Sequence and Phase Conformity



CAUTION

While measuring, the instrument must be held in the operator's hand.

Phase sequence test

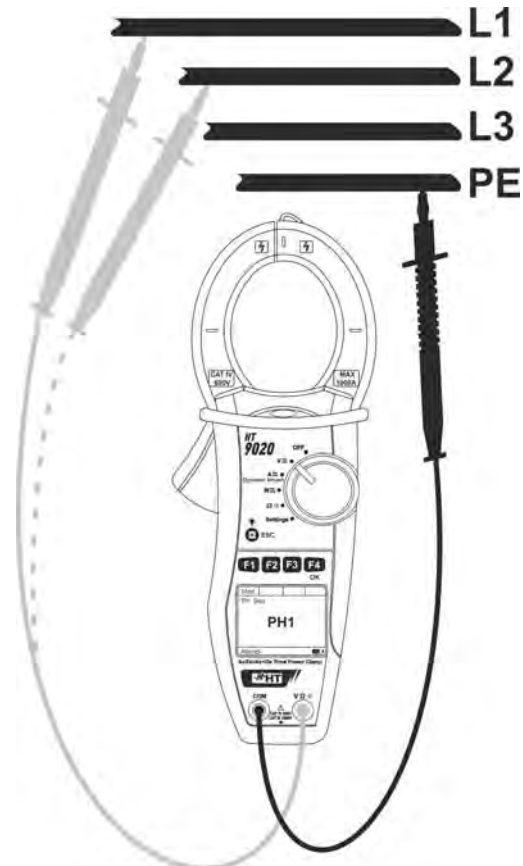

Fig. 7: Verification of phase sequence

1. Press **F1 (Mod)** to open the drop-down menu shown on the screen nearby and select the "**Ph Seq**" option with the same key
2. Press **F4 (OK)** to confirm

Mod			OK
AC		< 42.5	Hz
DC			
Ph Seq			
Help		--	V

3. The instrument shows the "**PH1**" message and waits for the detection of L1 phase
4. Connect red cable to input lead **VΩ** and black cable to input lead **COM** then position the leads respectively to the L1 phase and the ground reference PE of the circuit under test (see Fig. 7).

Mod			
Ph Seq			
		PH1	
Wait			



CAUTION

If the frequency of the measured voltage is lower than 42.5Hz or higher than 69Hz, the display shows the message "**F<42.5 Hz**" or "**F>69 Hz**" and phase detection does not start.

5. When a voltage higher than or equal to 100V is detected, the instrument emits a sound signal (buzzer) and the message "**Meas**" is displayed. Do not press any key and keep the test lead connected to L1 phase cable.

Mod			
Ph Seq			
PH1			
Meas			█

6. Once phase L1 acquisition is complete, the instrument stops the acoustic signal and the "**Discon.**" Message is shown. Disconnect the test lead from phase L1 cable.

Mod			
Ph Seq			
Discon.			
Wait			█

7. The message "**PH2**" is shown and the instrument waits for the detection of L2 phase. Connect the test lead to phase L2 cable (see Fig. 7)

Mod			
Ph Seq			
PH2			
Wait			█



CAUTION

If more than 3 seconds elapse before detecting phase L2, the instrument displays the message "**Time Out**". It is necessary to repeat the measuring cycle from the beginning, by pressing **F3 (New)** and starting again from point 3.

8. When a voltage higher than or equal to 100V is detected, the instrument emits a sound signal (buzzer) and the message "**Meas**" is displayed. Do not press any key and keep the test lead connected to L2 phase cable

Mod			
Ph Seq			
PH2			
Meas			█

9. If the two phases, to which the test lead has been connected, are in the correct sequence, the message “**123**” is displayed. If the phase sequence is incorrect, the message “**132**” is displayed

Mod		New	
Ph Seq			
1 2 3			
▬			

10. To start a new measurement, press **F3 (New)**

Phase conformity test



CAUTION

While measuring, the instrument must be held in the operator's hand.

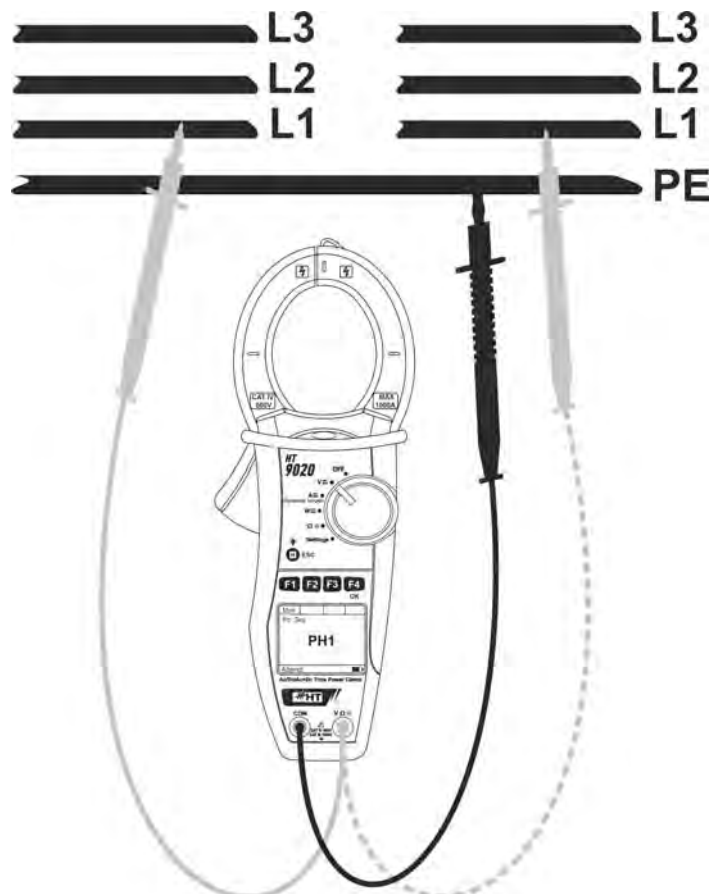

Fig. 8: Verification of phase conformity

1. The instrument shows the screen nearby, and waits for the detection of L1 phase of the first system
2. Connect the red cable to the input lead **VΩ** and the black cable to the input lead **COM** then position the leads respectively to the L1 phase of the first system and the ground reference PE of the circuit under test (see Fig. 8)

Mod			
Ph Seq			
PH1			
Wait			
▬			

3. When a voltage higher than or equal to 100V is detected, the instrument emits a sound signal (buzzer) and the message “**Meas**” is displayed. Do not press any key and keep the test lead connected to L1 phase cable of the first system

Mod			
Ph Seq			
PH1			
Meas			

4. Once the voltage of L1 phase acquisition is complete, the instrument stops the sound signal and the “**Discon.**” Message is displayed. Disconnect the test lead from L1 phase of the first system.

Mod			
Ph Seq			
Discon.			
Wait			

5. The message “**PH2**” is displayed and the instrument waits for the detection of L1 phase of the second system. Connect the test lead to L1 phase of the second system.

Mod			
Ph Seq			
PH2			
Wait			

CAUTION



If more than 3 seconds elapse before detecting the phase L1 of the second sequence, the instrument displays the message “**Time Out**”. It is necessary to repeat the measuring cycle from the beginning, by pressing **F3 (New)** key and starting again from step 1.

6. When a voltage higher than or equal to 100V is detected, the instrument emits a sound signal (buzzer) and the message “**Meas**” is displayed. Do not press any key and keep the test lead connected to L1 phase cable of the second system

Mod			
Ph Seq			
PH2			
Meas			

7. If there is correct conformity between the two phases, to which the test lead has been connected, the message “**11-**” is displayed. If not, the messages “**123**” or “**132**” are displayed.

To start a new measurement, press **F3 (New)**.

Mod		New	
Ph Seq			
11 -			

5.5. DC CURRENT MEASUREMENT



CAUTION

- The maximum measurable DC current is 1000A. When the display shows “> 999.9A”, it means that the maximum value that the clamp is capable of measuring has been exceeded. Exceeding these limits could result in electrical shocks to the user and damage to the instrument
- We recommend holding the clamp respecting the safety area created by the hand protection (see Fig. 3)

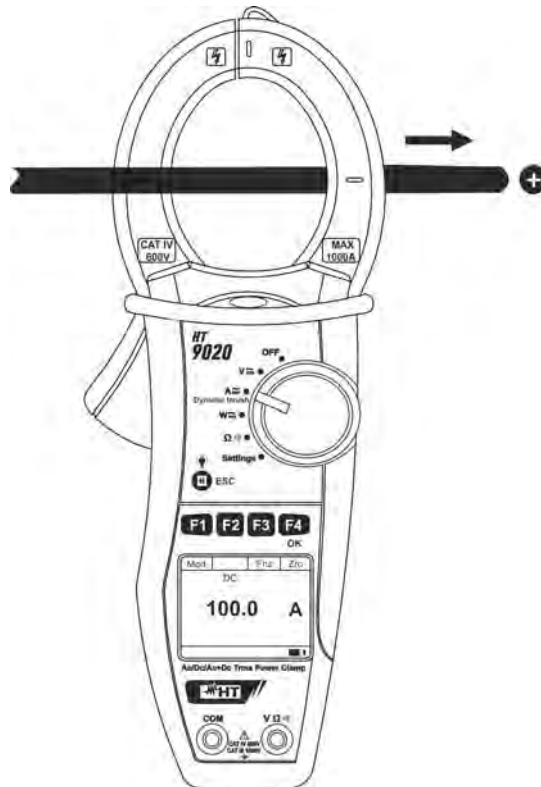

Fig. 9: DC current measurement

1. After positioning the selector switch to “**A**”, the screen nearby will appear.

Mod	Har	Fnc	Zro
	AC	< 42.5	Hz
		0.0	A

2. Press **F1 (Mod)** to open the drop-down menu shown on the screen aside and select the “**DC**” option with the same key
3. Press **F4 (OK)** to confirm
4. Press **F4 (Zro)** to perform the zero of value at display

Mod	Har	Fnc	OK
AC			5 Hz
DC			
Inrush 100A			
Inrush 1000A			A
Esc			

5. Connect the cable to the middle of the clamp jaws, in order to get accurate measurements (see Fig. 9). Use the marks as a reference (see Fig. 2)

6. The screen shows an example of DC current measurement.

Mod		Fnc	Zro
	DC		
	100.0		A
█			

7. Press **F3 (Fnc)** to open the drop-down menu shown on the screen aside. At each subsequent pressure of key **F3**, the cursor will scroll through the available items, as follows:

- **Max**: it constantly displays the maximum value of DC current
- **Min**: it constantly displays the minimum selected value of DC current
- **Cr+**: it constantly displays the maximum positive crest value
- **Cr-**: it constantly displays the minimum negative crest value
- **RST**: (RESET) it deletes all stored Max, Min, Cr+ and Cr- values and re-start with a new measure
- **Esc**: it goes back to a normal measuring mode

Mod		Fnc	OK
	DC	Max	
	100	Min	
		Cr+	
		Cr-	A
		RST	
		Esc	
█			



CAUTION

- Always carry out current zeroing before clamping the cable
- The measurement of the 4 Max, Min, Cr+ and Cr- values is simultaneous, regardless of the one displayed.

8. Pressing **F4 (OK)**, the selected item is confirmed. Nearby, an example of measurement with active Max function. The display shows the active function.

Mod		Fnc	Zro
Max	DC		
	120.0		A
█			

9. For the use of HOLD and backlight features see § 5.1

5.6. AC/AC + DC CURRENT MEASUREMENT

CAUTION



- The maximum measurable AC/AC+DC current is 1000A. When the display shows “> 999.9A”, it means that the maximum value that the clamp is capable of measuring has been exceeded. Exceeding these limits could result in electrical shocks to the user and damage to the instrument
- We recommend holding the clamp respecting the safety area created by the hand protection (see Fig. 3)

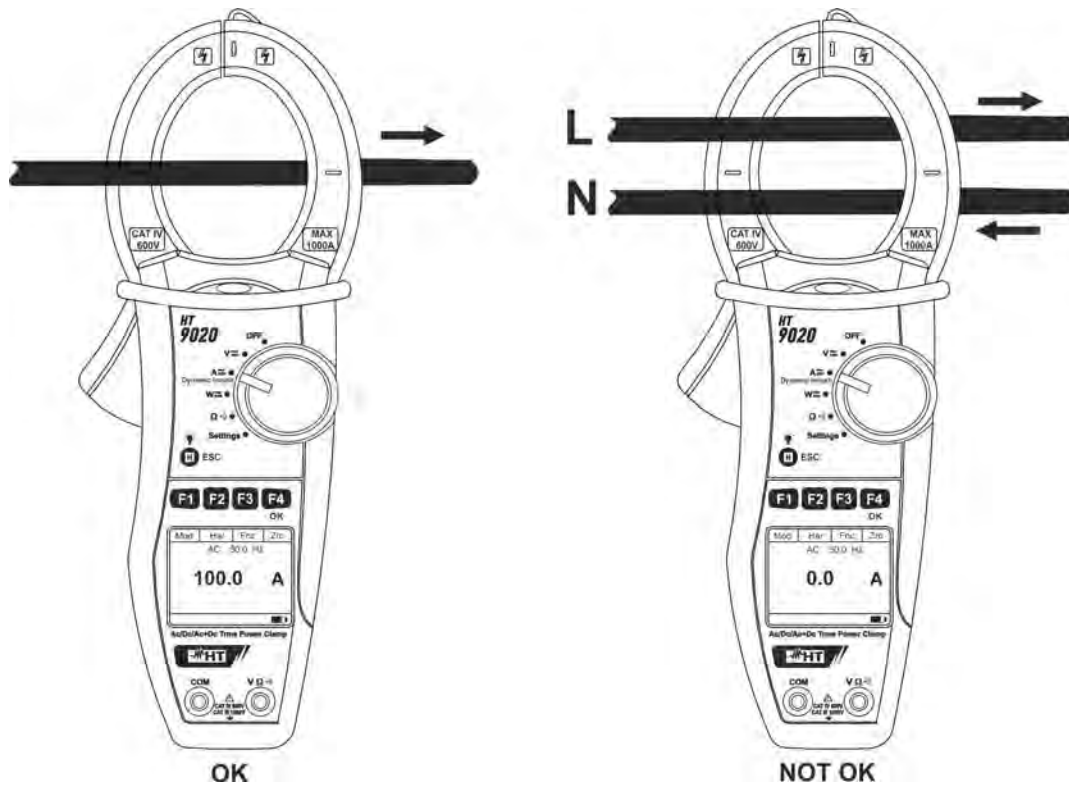

Fig. 10: AC/AC + DC current measurement

1. Positioning the selector switch to “**A \approx** ”, the screen nearby will appear.

Mod	Har	Fnc	Zro
	AC	< 42.5	Hz
		0.0	A

2. Press **F1 (Mod)** to open the drop-down menu shown on the screen nearby and select the “**AC**” option with the same key
3. Press **F4 (OK)** to confirm
4. Press **F4 (Zro)** to perform the zero of value at display

Mod	Har	Fnc	OK
AC			5 Hz
DC			
Inrush	100A		
Inrush	1000A		A
Esc			

5. Connect the cable to the middle of the clamp jaws, in order to get accurate measurements (see Fig. 10 – left part). Use the marks as a reference (see Fig. 2)

6. The screen shows an example of AC current measurement. The instrument allows the evaluation of possible DC components overlapped on a generic alternate waveform signal (AC+DC) and this can be very useful for measurements on impulsive signals typically of no-linear loads (e.g.: welders, electric ovens, etc.)

Mod	Har	Fnc	Zro
	AC	50.0	Hz
100.0			A

7. Press **F3 (Fnc)** to open the drop-down menu shown on the screen aside. At each subsequent pressure of key **F3**, the cursor will scroll through the available items, as follows:

- **Max**: it constantly displays the maximum value of AC + DC current
- **Min**: it constantly displays the minimum selected value of AC + DC current
- **Cr+**: it constantly displays the maximum positive crest value
- **Cr-**: it constantly displays the minimum negative crest value
- **RST**: (RESET) it deletes all stored Max, Min, Cr+ and Cr- values and re-start with a new measure
- **Esc**: it goes back to a normal measuring mode

Mod		Fnc	OK
	AC	Max	
100			A
		Min	
		Cr+	
		Cr-	
		RST	
		Esc	



CAUTION

- Always carry out current zeroing before clamping the cable
- The measurement of the 4 Max, Min, Cr+ and Cr- values is simultaneous, regardless of the one displayed.

8. Pressing **F4 (OK)**, the selected item is confirmed. Nearby an example of measurement with active Max function. The display shows the active function.

Mod	Har	Fnc	Zro
Max	AC	50.0	Hz
120.0			A

9. For the use of HOLD and backlight features see § 5.1

5.6.1. Current Harmonics measurement

1. Press the **F2 (Har)** key to select the screen of current harmonics as shown nearby. Press again the **F2 (RMS)** to go back to current measurement screen

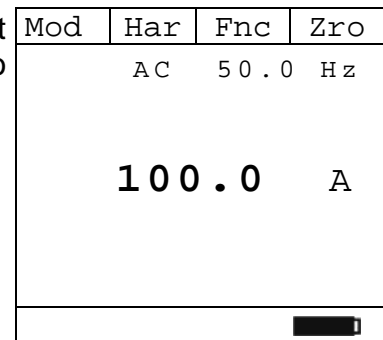

2. Pressing **F1 (◀)** or **F4 (▶)** it is possible to move the cursor over the graph and select the harmonic to be measured. The correspondent absolute or percentage value of harmonic current is displayed. It is possible to measure up to the 25th harmonic

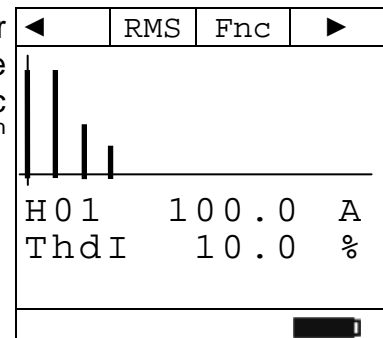

3. Press **F3 (Fnc)** to open the drop-down menu shown on the screen aside. At each subsequent pressure of key **F3**, the cursor will scroll through the available items as follows:
 - **Max**: it constantly displays the maximum RMS value of the selected current harmonic
 - **Min**: it constantly displays the minimum RMS value of the selected current harmonic
 - **Abs**: it displays the absolute value of the harmonics
 - **%**: it displays the value of the harmonics as percentage value with respect to the fundamental
 - **RST**: (RESET) it deletes all stored Max, Min values and re-start with a new measure
 - **Esc**: it goes back to a normal measuring mode

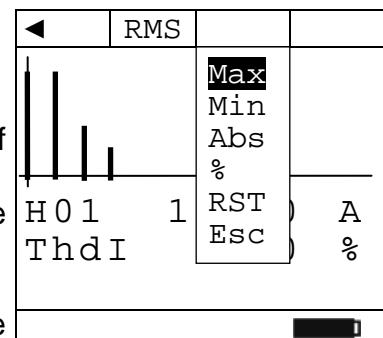

CAUTION

Since the menu contains functions with a different meaning (Max-Min and Abs-%), it is necessary to enter the menu twice: once for displaying Abs or % values and second time to enable the Max or Min functions.

4. Pressing **F4 (OK)**, the selected item is confirmed. Nearby, an example of measurement with active Max function. The display shows the active function.

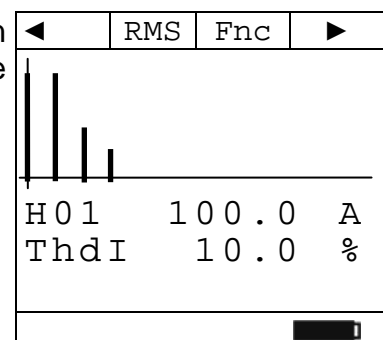

5. For the use of HOLD and backlight features see § 5.1

5.6.2. Dynamic Inrush current measurement



CAUTION

- The maximum measurable AC/AC+DC current is 1000A. Do not measure currents exceeding the limits given in this manual. Exceeding these limits could result in electrical shocks to the user and damage to the instrument.
- We recommend holding the clamp respecting the safety area created by the hand protection (see Fig. 3).
- Currents <2A are zeroed.

1. Press **F1 (Mod)** to select the inrush current measurement between the “**Inrush 100A**” (for inrush current <100A) or “**Inrush 1000A**” (for inrush current <1000A) options as shown asides **F4 (OK)** to confirm

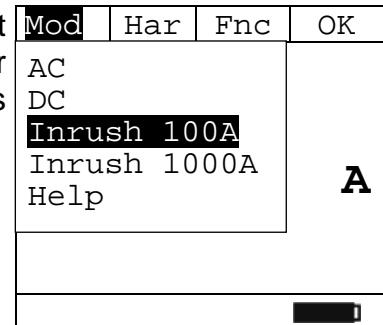

2. Press **F3 (Lim)** for the setting of limit threshold value on inrush current and the type of measurement as shown asides

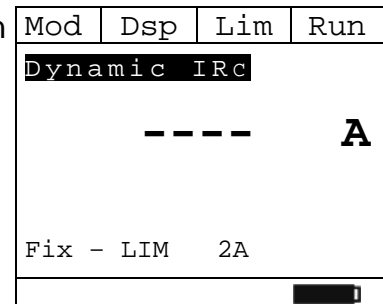

3. Press **F2 (◀)** or **F3 (▶)** to set the reference threshold for the saving of event (**2A ÷ 100A** for “Inrush 100A” and **5A ÷ 900A** for “Inrush 1000A”)
4. Press **F4 (OK)** to confirm and return to main screen.

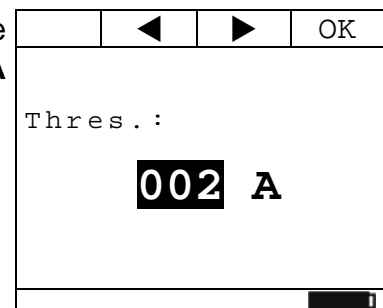

5. Press **F4 (Run)** key to start the detection of the inrush current event. Press **F4 (Stp)** to stop the detection of the inrush current event in any time. After the detection of the event (when the measured current is over the limit threshold), **the measurement is automatically stopped** by the instrument and the maximum RMS value in 100ms is displayed as shown asides

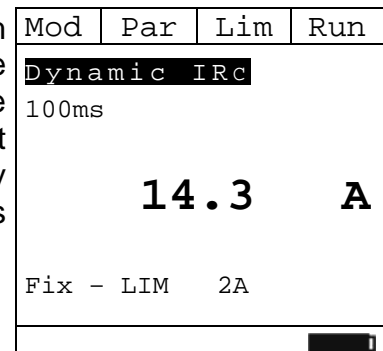

6. Press **F2 (Dsp)** to select the available values, as follows:

- **PK** → Peak value in **1ms**
- Max RMS value in **16.7ms**
- Max RMS value in **20ms**
- Max RMS value in **50ms**
- Max RMS value in **100ms**
- Max RMS value in **150ms**
- Max RMS value in **200ms**

Mod	Dsp	Lim	Run
PK			
		18.2	A
Fix - LIM 2A			
█			

7. Press **F4 (Run)** to start a new measurement or move the selector to exit from the function

5.7. DC POWER AND ENERGY MEASUREMENT

CAUTION



- The maximum DC input voltage is 1000V and the maximum measurable DC current is 1000A. Do not measure voltages and currents exceeding the limits given in this manual. Exceeding these limits could result in electrical shocks to the user and damage to the instrument
- We recommend holding the clamp respecting the safety area created by the hand protection (see Fig. 3)

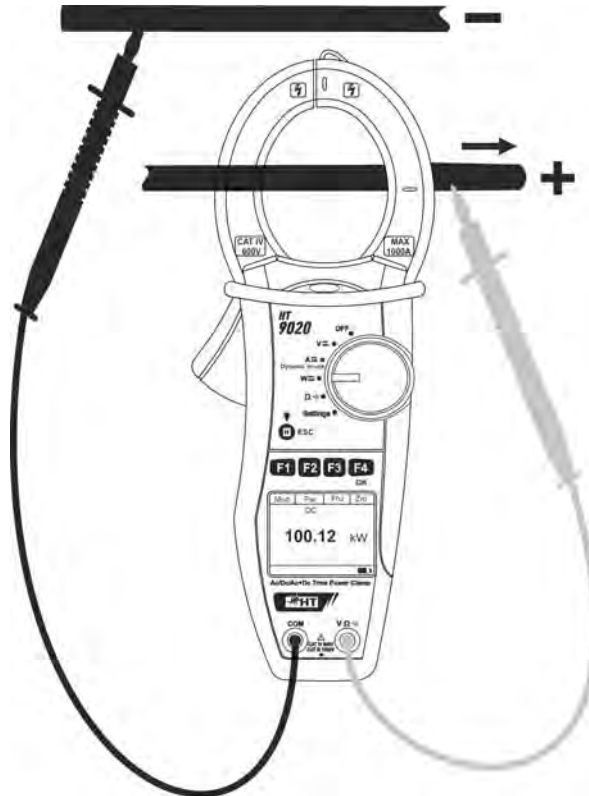

Fig. 11: DC power/energy measurement

1. After positioning the selector switch to “**W**”, the screen aside will appear.

Mod	Par	Fnc	Zro
	AC	<10.0	Hz
	---		kW
	---		kV a r i
	---		kVA
			1 P

2. Press **F1 (Mod)** to open the drop-down menu shown on the screen aside and select the “**DC**” option with the same key
3. Press **F4 (OK)** to confirm

Mod	Par	Fnc	OK
AC	1P	<10.0	Hz
AC	3P		
DC	--		kW
Help	--		kV a r i
	---		kVA

4. Press **F4 (Zro)** to perform the zero of value at display

Mod	Par	Fnc	Zro
DC			
0.00		kW	

5. Connect red cable to input lead **VΩ** and black cable to input lead **COM**. Position red lead to “+” and black lead to “-” then connect “+” cable to the clamp jaws, respecting the direction of current indicated by the arrow (see Fig. 11). Connect the cable to the middle of the clamp jaws, in order to get accurate measurements. Use the marks as a reference (see Fig. 2)

6. The value of DC power is displayed expressed in kW. Press **F2 (Par)** to open the drop-down menu shown on the screen aside and select the “**Volt/Curr**” option for the DC voltage and current measurement. Confirm with **F4 (OK)**. The following screen is displayed:

Mod	Par	Fnc	OK
Power			
Volt/Curr			
Energy			
1.60		kW	

7. The screen shows an example of DC Voltage and Current measurements.

Mod	Par	Fnc	Zro
DC			
80.0		V	
20.0		A	

8. Press **F2 (Par)** to open the drop-down menu shown on the screen aside and select the “**Energy**” option for the DC energy measurement. Confirm with **F4 (OK)**. The following screen is displayed:

Mod	Par	Fnc	OK
Power			
Volt/Curr			
Energy			
1.60		kW	

9. Press **F4 (Run)** to start the energy measurement. A counter in the bottom of the display is activated

Mod	Par		Run
	DC		
		0.000	kWh
		0000:00:00	

10. Press **F4 (Stp)** to stop the energy measurement. The correspondent value is displayed. Press **F4 (Run)** again to zero the counter and start a new energy measurement

Mod	Par		Stp
	DC		
		3.200	kWh
		0002:00:00	

11. While measuring DC Power, press **F3 (Fnc)** to open the drop-down menu shown on the screen aside. At each subsequent pressure of **F3**, the cursor will scroll through the available items, as follows:

- **Max**: it constantly displays the maximum value of the measured parameter
- **Min**: it constantly displays the minimum value of the measured parameter
- **RST**: (RESET) it deletes all stored Max, Min values and re-start with a new measure
- **Esc**: it goes back to a normal measuring mode

Mod	Par	Fnc	OK
	DC	Max	
		Min	
		RST	
		Esc	
			kW
			0.

12. By pressing **F4 (OK)**, the selected item is confirmed. Nearby, an example of measurement with active Max function. The display shows the active function.

Mod	Par	Fnc	Zro
Max	DC		
		2.40	kW

13. While measuring Voltage and Current, press **F3 (Fnc)** to open the drop-down menu shown on the screen aside. At each subsequent pressure of **F4**, the cursor will scroll through the available items, as follows:

- **Max**: it constantly displays the maximum value of the measured parameter
- **Min**: it constantly displays the minimum value of the measured parameter
- **Cr+**: it constantly displays the maximum positive crest value measured
- **Cr-**: it constantly displays the minimum negative crest value measured
- **RST**: (RESET) it deletes all stored Max, Min, Cr+ and Cr- values and re-start with a new measure
- **Esc**: it goes back to a normal measuring mode

Mod	Par	Fnc	OK
	DC	Max	
		Min	
	80	Cr+	V
		Cr-	
	20	RST	A
		Esc	

14. By pressing **F4 (OK)**, the selected item is confirmed. Nearby, an example of measurement with active Max function. The display shows the active function.

Mod	Par	Fnc	OK
Max	DC		
		80.0	V
		20.0	A

15. For the use of HOLD and backlight features see § 5.1

5.8. AC/AC+DC POWER AND ENERGY MEASUREMENT

CAUTION

- The maximum AC/AC+DC input voltage is 1000V and the maximum measurable AC/AC+DC current is 1000A. Do not measure voltages and currents exceeding the limits given in this manual. Exceeding these limits could result in electrical shocks to the user and damage to the instrument
- We recommend holding the clamp respecting the safety area created by the hand protection (see Fig. 3)

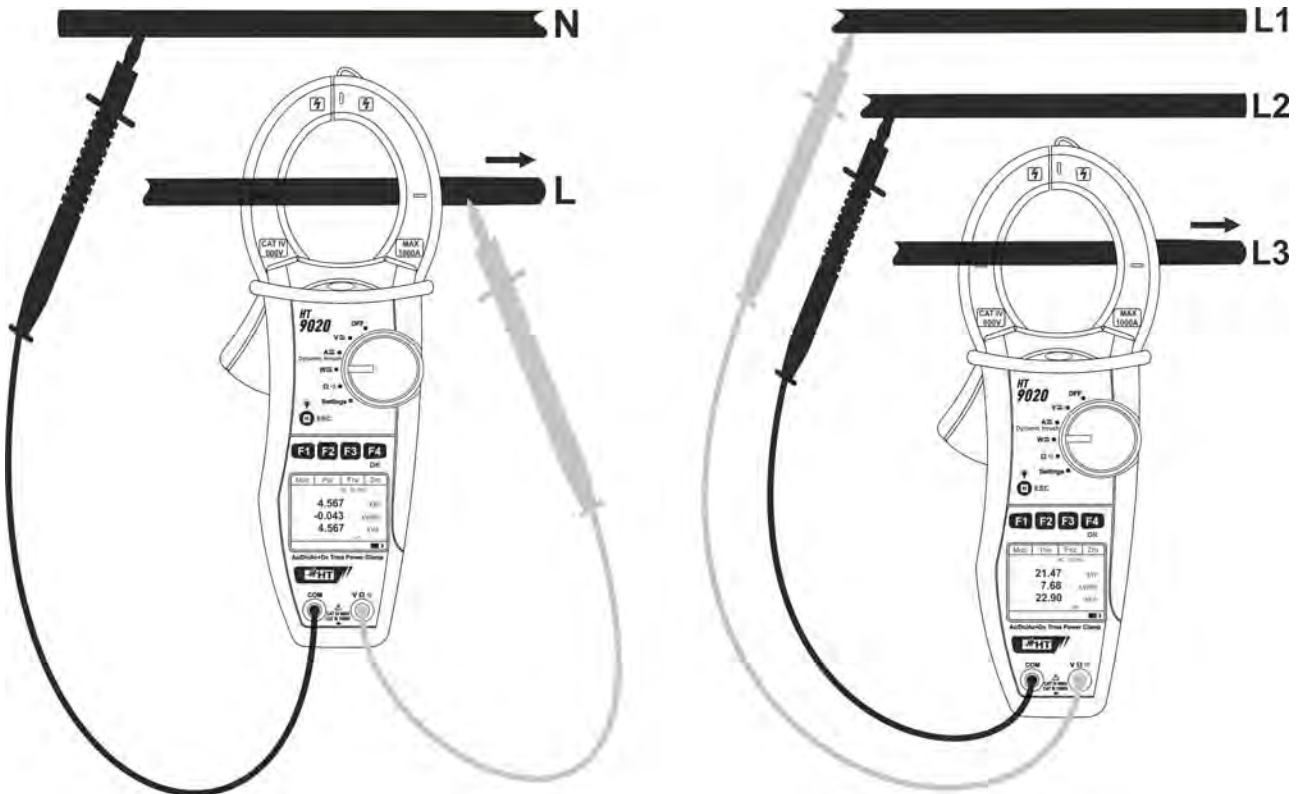

Fig. 12: AC/AC+DC power measure on Single phase and balanced Three phase systems

1. After positioning the selector switch to “**W_~**”, the screen aside will appear.

Mod	Par	Fnc	Zro
	AC	<10.0	Hz
	---		kW
	---		kVARI
	---		kVA
			1P

2. Press **F1 (Mod)** to open the drop-down menu shown on the screen aside and select the “**AC 1P**” (Single phase measurement) or “**AC 3P**” (balanced Three phase measurement) options with the same key. The “**1P**” or “**3P**” symbols are displayed.
3. Press **F4 (OK)** to confirm

Mod	Par	Fnc	OK
AC 1P		<10.0	Hz
AC 3P			kW
DC			kVARI
Help			kVA

4. Press **F4 (Zro)** to perform the zero of value at display

Mod	Par	Fnc	Zro
AC			
0.00 kW			
█			

5. Connect red cable to input lead **VΩ⁽ⁱ⁾** and black cable to input lead **COM** then perform the connection as indicated in Fig. 12 depending on the type of system under test. Put the phase cable into the clamp jaws respecting the direction of current indicated by the arrow (see Fig. 12). Connect the cable to the middle of the clamp jaws, in order to get accurate measurements. Use the marks as a reference (see Fig. 2)

6. The value of AC powers (active , reactive and apparent) is displayed. The instrument allows the evaluation of possible DC components overlapped on a generic alternate waveform signal (AC+DC) and this can be very useful for measurements on impulsive signals typically of no-linear loads (e.g.: welders, electric ovens, etc.)
Press **F2 (Par)** and select with the same key the “**PF-DPF**” option for the power factor (PF) and Cosphi (DPF) measurement. Confirm with **F4 (OK)**. The following screen is displayed:

Mod	Par	Fnc	OK
P-Q-S			
PF-DPF			
Volt/Curr			
Harm Voltage			
Harm Current			
Energy			
1 P			
█			

7. The screen shows an example of PF and DPF measurement. The “**i**” and “**c**” symbols mean respectively the inductive or capacitive nature of the load.

Mod	Par	Fnc	Zro
AC		50.0 Hz	
PF	0.94	i	
DPF	0.94	i	
1 P			
█			

8. Press **F2 (Par)** to open the drop-down menu shown on the screen aside and select the “**Volt/Curr**” option for the voltage and current measurement. Confirm with **F4 (OK)**. The following screen is displayed.

Mod	Par	Fnc	OK
P-Q-S			
PF-DPF			
Volt/Curr			
Harm Voltage			
Harm Current			
Energy			
1 P			
█			

9. Nearby, an example of measurement of AC voltage and current in a single phase system.

Mod	Par	Fnc	Zro
	AC	50.0	Hz
		229.7	V
		99.6	A
		1 P	

10. Press **F2 (Par)** to open the drop-down menu shown on the screen aside and select the “**Harm Voltage**” for the reading of AC+DC voltage harmonic value. Confirm with **F4 (OK)**. The following screen is displayed.

Mod	Par	Fnc	OK
	P-Q-S		
	PF-DPF		
	Volt/Curr		
	Harm Voltage		
	Harm Current		
	Energy		
		1 P	

11. Pressing **F1 (◀)** or **F4 (▶)**, it is possible to move the cursor over the graph and select the harmonic to be measured. The correspondent absolute or percentage value of harmonic voltage is displayed. It is possible to measure up to the 25th harmonic.

◀	Par	Fnc	▶
	h05	2.3	V
	ThdV	2.4	%

12. Press **F2 (Par)** to open the drop-down menu shown on the screen aside and select the “**Harm Current**” for the reading of current harmonic value. Confirm with **F4 (OK)**. The following screen is displayed.

Mod	Par	Fnc	OK
	P-Q-S		
	PF-DPF		
	Volt/Curr		
	Harm Voltage		
	Harm Current		
	Energy		
		1 P	

13. Pressing **F1 (◀)** or **F4 (▶)** it is possible to move the cursor over the graph and to select the harmonic to be measured. The correspondent absolute or percentage value of harmonic current is displayed. It is possible to measure up to the 25th harmonic

◀	Par	Fnc	▶
	h05	2.9	A
	ThdI	10.7	%

14. Press **F3 (Fnc)** to open the drop-down menu shown on the screen aside. At each subsequent pressure of key **F3**, the cursor will scroll through the available items, as follows:
- **Max**: it constantly displays the maximum RMS value of the selected voltage or current harmonic
 - **Min**: it constantly displays the minimum RMS value of the selected voltage or current harmonic
 - **Abs**: it displays the absolute value of the harmonics
 - **%**: it displays the value of the harmonics as percentage value with respect to the fundamental
 - **RST**: (RESET) it deletes all stored Max, Min values and re-start with a new measure
 - **Esc**: it goes back to a normal measuring mode

◀	Par	Fnc	OK
		Max Min Abs % RST Esc	
H01	1		V
ThdV			%



CAUTION

Since the menu contains functions with a different meaning (Max-Min and Abs-%), it is necessary to enter the menu twice: once for displaying Abs or % values and second time to enable the Max or Min functions.

15. Pressing **F4 (OK)**, the selected item is confirmed. Nearby, an example of current harmonic measurement with active Max function. The display shows the active function.

◀	RMS	Fnc	▶
H01	100.0	A	
ThdI	10.0	%	

16. Press **F2 (Par)** to open the drop-down menu shown on the screen aside and select the “**Energy**” option for the energy measurement. Confirm with **F4 (OK)**. The following screen is displayed:

Mod	Par	Fnc	OK
	P-Q-S PF-DPF Volt/Curr Harm Voltage Harm Current Energy		

17. Press **F4 (Run)** to start the energy measurement. A counter in the bottom of the display is activated

Mod	Par	Fnc	Run
	AC	50.0	Hz
	0.000		kWh
	0.000		kVar _{ih}
	0.000		kVar _{ch}
0000:00:00			1P

18. Press **F4 (Stp)** to stop the energy measurement. The corresponding value is displayed. Press **F4 (Run)** again to zero the counter and start a new energy measurement.

Mod	Par	Fnc	Stp
	AC	50.0	Hz
		2.242	kWh
		0.841	kVar i h
		0.000	kVarch
		0002:00:00 1P	

19. While measuring P-Q-S power or PF-DPF, press **F3 (Fnc)** to open the drop-down menu shown on the screen aside. At each subsequent pressure of **F3**, the cursor will scroll through the available items, as follows:

- **Max**: it constantly displays the maximum value of the measured parameter
- **Min**: it constantly displays the minimum value of the measured parameter
- **RST**: (RESET) it deletes all stored Max, Min values and re-start with a new measure
- **Esc**: it goes back to a normal measuring mode

Mod	Par	Fnc	OK
	AC	Max	Hz
		Min	kW
		21.4	RST
		7.6	Esc
		22.90	kVA
		1P	

20. Pressing **F4 (OK)**, the selected item is confirmed. Nearby, an example of power measurement with active Max function. The display shows the active function.

Mod	Par	Fnc	Zro
Max	AC	50.0	Hz
		21.47	kW
		7.68	kVar i
		22.90	kVA
		1P	

21. While measuring AC+DC voltage or current, press **F3 (Fnc)** to open the drop-down menu shown on the screen aside. At each subsequent pressure of **F3**, the cursor will scroll through the available items, as follows:

- **Max** → it constantly displays the maximum value of the measured parameter
- **Min** → it constantly displays the minimum value of the measured parameter
- **Cr+** → it constantly displays the maximum positive crest value measured
- **Cr-**: it constantly displays the minimum negative crest value measured
- **RST** → (RESET) it deletes all stored Max, Min, Cr+ and Cr- values and re-start with a new measure
- **Esc**: it goes back to a normal measuring mode

Mod	Par	Fnc	OK
	AC	Max	Hz
		Min	V
		80	Cr+
		20	Cr-
		RST	A
		Esc	

22. Pressing **F4 (OK)**, the selected item is confirmed. Nearby, an example with active Max function. The display shows the active function.

Mod	Par	Fnc	Zro
Max	AC	50.0	Hz
	80.0		V
	20.0		A
[]			

23. For the use of HOLD and backlight features see § 5.1

5.9. RESISTANCE AND CONTINUITY TEST MEASUREMENT



CAUTION

Before attempting any resistance measurement, remove power from the circuit under test and discharge all capacitors, if present.

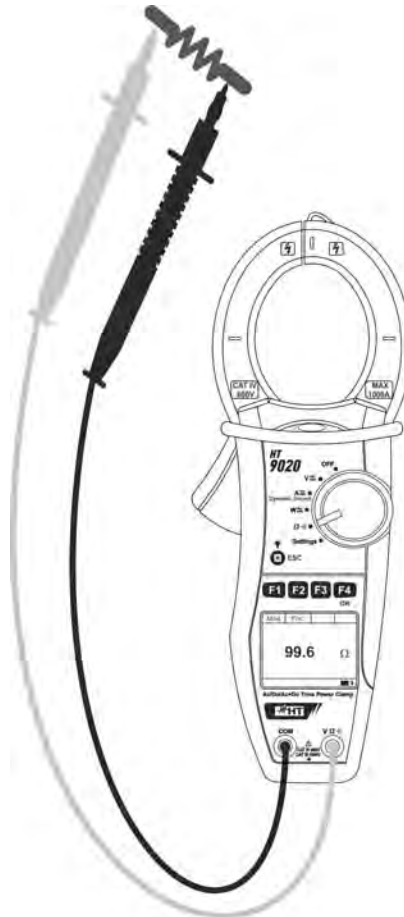

Fig. 13: Resistance measurement

1. Positioning the selector switch to “Ω””, the screen aside will appear.

Mod	Fnc		
<p>> 30.0 kΩ</p>			

2. Press **F1 (Mod)** to open the drop-down menu shown on the screen aside and select the “Resistance” option with the same key
3. Press **F4 (OK)** to confirm

Mod	Fnc		OK
<p>Resistance</p> <p>Continuity</p> <p>Help</p>			
<p>> 30.0 kΩ</p>			

4. Connect red cable to the input lead **VΩ** and black cable to the input lead **COM**, then connect the instrument as described in Fig. 13

5. The screen shows an example of Resistance measurement.

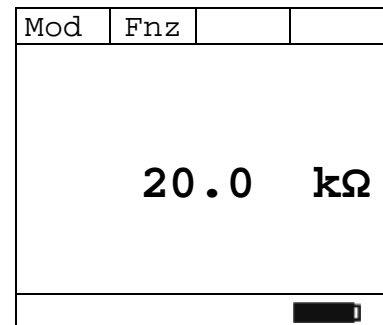

6. Press **F1 (Mod)** to open the drop-down menu shown on the screen aside and select the “**Continuity**” option with the same key

7. Press **F4 (OK)** to confirm. The instrument changes into Continuity test mode and the following screen is displayed.

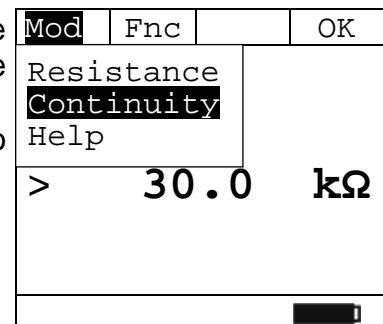

8. Press **F3(Lim)** key to set the limit value of Continuity test (if the measured resistance is lower than the set limit resistance value (e.g. Res Lim: 1Ω), the buzzer sounds continuously).

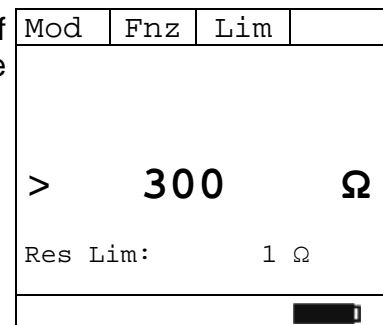

9. Press **F2 (◀)** or **F3 (▶)** and set the limit value within the **1Ω ÷ 150Ω** interval

10. Press **F4 (OK)** to confirm.



11. While measuring Resistance or Continuity, press **F2 (Fnc)** to open the drop-down menu shown on the screen aside. At each subsequent pressure of **F2**, the cursor will scroll through the available items, as follows:

- **Max**: it constantly displays the maximum resistance value measured
- **Min**: it constantly displays the minimum resistance value measured
- **RST**: (RESET) it deletes all stored Max, Min values and re-start with a new measure
- **Esc**: it goes back to a normal measuring mode

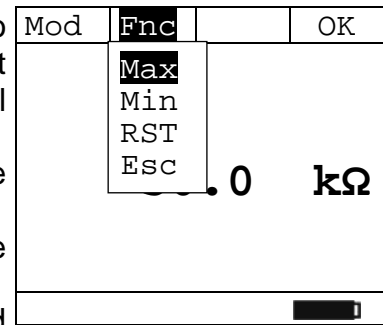

12. Pressing **F4 (OK)**, the selected item is confirmed. Nearby, an example of measurement with active Max function. The display shows the active function.

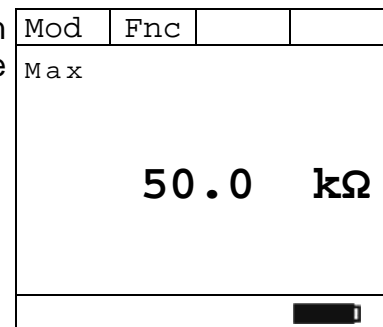

13. For the use of HOLD and backlight features see § 5.1

6. MAINTENANCE

6.1. GENERAL INFORMATION

1. The instrument you purchased is a precision instrument. While using and storing the instrument, carefully observe the recommendations listed in this manual in order to prevent possible damage or danger during use.
2. Do not use the instrument in environments with high humidity levels or high temperatures. Do not expose to direct sunlight.
3. Always switch off the instrument after use. In case the instrument is not to be used for a long time, remove the batteries to avoid acid leaks that could damage the instrument's internal circuits.

6.2. BATTERY REPLACEMENT



CAUTION

Only expert and trained technicians should perform this operation.
Before carrying out this operation, make sure you have removed all cables from input leads or the cable under test from clamp jaws.

1. Turn the switch on **OFF** position.
2. Disconnect the cables from the inputs and the cable under test from the clamp jaws.
3. Loosen the screws from battery cover and remove it.
4. Remove the flat batteries from the battery compartment.
5. Insert two new batteries of the same type (see § 7.1.2). Pay attention to the correct polarity.
6. Place the battery cover over the compartment and fasten it with the relevant screws.
7. Do not waste old batteries into the environment. Use the relevant containers for disposal.

6.3. CLEANING THE INSTRUMENT

Use a soft and dry cloth to clean the instrument. Never use wet cloths, solvents, water, etc.

6.4. END OF LIFE



CAUTION: the symbol on the instrument indicates that the appliance and its accessories must be collected separately and correctly disposed of.

7. TECHNICAL SPECIFICATIONS

7.1. TECHNICAL CHARACTERISTICS

Accuracy indicated as $\pm[\%rdg + (\text{num digit} * \text{resolution})]$ referred to $23^{\circ}\text{C} \pm 5^{\circ}\text{C}$, $< 80\%HR$.

DC Voltage

Range	Resolution	Accuracy	Protection against overload
0.1 ÷ 999.9V	0.1V	$\pm(1.0\%rdg+3dgt)$	1000VDC/ACrms

Input impedance: $1M\Omega$

AC Voltage (AC+DC TRMS)

Range	Resolution	Accuracy	Protection against overload
0.1 ÷ 999.9V	0.1V	$\pm(1.0\%rdg+3dgt)$	1000VDC/ACrms

Input impedance: $1M\Omega$; Max. Crest Factor: 1.41, Fundamental: 50/60Hz $\pm 15\%$, Bandwidth: 42.5Hz ÷ 1725Hz

AC/DC Voltage: MAX / MIN / CREST

Function	Range	Resolution	Accuracy	Response time
MAX,MIN,CREST	0.5÷999.9V	0.1V	$\pm(3.5\%rdg+5dgt)$	1sec

Input impedance: $1M\Omega$; Max. Crest Factor: 1.41, Fundamental: 50/60Hz $\pm 15\%$, Bandwidth: 42.5Hz ÷ 1725Hz

DC Current

Range	Resolution	Accuracy	Protection against overload
0.1 ÷ 999.9A	0.1A	$\pm(2.0\%rdg+5dgt)$	1000ADC/ACrms

AC Current (AC+DC TRMS)

Range	Resolution	Accuracy	Protection against overload
0.5 ÷ 999.9A	0.1A	$\pm(1.0\%rdg+5dgt)$	1000ADC/ACrms

Max. Crest Factor: 1.41, Fundamental: 50/60Hz $\pm 15\%$, Bandwidth: 42.5Hz ÷ 1725Hz

AC/DC Current: MAX / MIN / CREST

Function	Range	Resolution	Accuracy	Response time
MAX,MIN,CREST	0.5÷999.9A	0.1A	$\pm(3.5\%rdg+5dgt)$	1sec

Max. Crest Factor: 1.41, Fundamental: 50/60Hz $\pm 15\%$, Bandwidth: 42.5Hz ÷ 1725Hz

Resistance and Continuity test

Range	Resolution	Accuracy	Protection against overload
0.0 Ω ÷ 199.9 Ω	0.1 Ω	$\pm(1.0\%rdg+5dgt)$	1000VDC/ACrms
200 Ω ÷ 1999 Ω	1 Ω		
2.00k Ω ÷ 19.99k Ω	0.01k Ω		
20.0k Ω ÷ 29.9k Ω	0.1k Ω		

Buzzer ON if $R \leq RLIM$, RLIM range: 1 ÷ 150 Ω

Frequency (with test leads/ with jaws)

Range	Resolution	Accuracy	Protection against overload
42.5 ÷ 69.0Hz	0.1Hz	$\pm(1.0\%rdg+5dgt)$	1000VDC/ACrms 1000ADC/ACrms

Voltage range for frequency measure: 0.5 ÷ 1000V / Current range for frequency measure with jaws: 0.5 ÷ 1000A

Inrush current (DC, AC+DC TRMS)

Range	Resolution	Peak accuracy	Max RMS accuracy	Protection against overload
1.0 ÷ 99.9A	0.1A	$\pm(2.0\%rdg + 5dgt)$	$\pm(2.0\%rdg + 5dgt)$	1000ADC/ACrms
10 ÷ 999A	1A			

Crest factor: 3, Sample frequency: 4kHz, Response time: Peak: 1ms, Max RMS : calculated on: 16.7, 20, 50, 100, 150, 200ms
Accuracy declared for frequency: DC, 42. .. 69Hz

Phase sequence and phase coincidence

Range	Frequency	Protection against overload
100 ÷ 1000V	42.5 ÷ 69Hz	1000VDC/ACrms

Input impedance: 1MΩ

DC Power

Range [kW]	Resolution [kW]	Accuracy
0.00 ÷ 99.99	0.01	±(3.0%rdg+3dgt)
100.0 ÷ 999.9	0.1	

Input impedance: 1MΩ, Accuracy referred for Voltage > 10V, Current ≥ 2A

Active, Apparent Power AC (AC + DC TRMS)

Range [kW], [kVA]	Resolution [kW], [kVA]	Accuracy
0.02 ÷ 99.99	0.01	±(2.0%rdg+3dgt)
100.0 ÷ 999.9	0.1	

Input impedance: 1MΩ, Accuracy referred for sinusoidal waveform, 42.5..69Hz, Voltage > 10V, Current ≥ 2A, Pf ≥ 0.5

Active Energy AC (AC + DC TRMS)

Range [kWh]	Resolution [kWh]	Accuracy
0.00 ÷ 99.99	0.01	±(2.0%rdg+3dgt)
100.0 ÷ 999.9	0.1	

Input impedance: 1MΩ, Accuracy referred for sinusoidal waveform, 42.5..69Hz, Voltage > 10V, Current ≥ 2A, Pf ≥ 0.5

Reactive Power AC (AC + DC TRMS)

Range [kVAR]	Resolution [kVAR]	Accuracy
0.02 ÷ 99.99	0.01	±(2.0%rdg+3dgt)
100.0 ÷ 999.9	0.1	

Input impedance: 1MΩ, Accuracy referred for sinusoidal waveform, 42.5..69Hz, Voltage > 10V, Current ≥ 2A, Pf ≤ 0.9

Reactive Energy AC (AC + DC TRMS)

Range [kVARh]	Resolution [kVARh]	Accuracy
0.00 ÷ 99.99	0.01	±(2.0%rdg+3dgt)
100.0 ÷ 999.9	0.1	

Input impedance: 1MΩ, Accuracy referred for sinusoidal waveform, 42.5..69Hz, Voltage > 10V, Current ≥ 2A, Pf ≤ 0.9

Power factor/cosphi

Range	Resolution	Accuracy
0.20 ÷ 1.00	0.01	±(2.0%rdg+2dgt)

Input impedance: 1MΩ, Accuracy referred for sinusoidal waveform, 42.5..69Hz, Voltage > 10V, Current ≥ 2A

Voltage and Current Harmonics

Harmonic order	Fundamental frequency	Resolution	Accuracy (* no zeroed values)
DC	42.5Hz ÷ 69Hz	0.1V / 0.1A	±(5.0%rdg+20dgt)
1 ÷ 25			±(5.0%rdg+10dgt)
THD%		0.1%	±(10.0%rdg+10dgt)

The accuracy of harmonics amplitude expressed in % is evaluated considering the accuracy of the parameters ratio

(*) Voltage harmonics are zeroed in the below conditions:

- 1st harmonic: if value < 0.5V
- DC, 2nd to 25th harmonics: if harmonic value <0.5% of fundamental value or if value < 0.5V

Current harmonics are zeroed in the below conditions:

- 1st harmonic: if value < 0.5A
- DC, 2nd to 25th harmonics: if harmonic value <0.5% of fundamental value or if value < 0.5A

7.1.1. Reference guidelines

Safety:	IEC/EN61010-1, IEC/EN61010-2-032
EMC :	IEC/EN61326-1
Technical documentation:	IEC/EN61187
Safety of measuring accessories:	IEC/EN61010-31
Insulation:	double insulation
Pollution level:	2
Max height of use:	2000m
Measurement category:	CAT IV 600V / CAT III 1000V to gnd, max 1000V between inputs

7.1.2. General characteristics

Mechanical characteristics

Dimensions (L x W x H):	252 x 88 x 44mm (9 x 3 x 2 in)
Weight (batteries included):	approx 420g (15 ounces)
Jaw opening / Max cable size:	45mm (1.8 in)

Power supply

Battery type:	2 batteries x 1.5V LR 03 AAA
Battery life:	approx. 150 hours of use in “W \approx ” position
Auto power OFF:	after 5 min of idleness (disabled)

Display

Characteristics:	graphic display 128x128 pixels
Sampling rate:	128 samples per period (base sampling)
Updating frequency:	1time/s

7.2. ENVIRONMENT

7.2.1. Environmental conditions for use

Reference calibration temperature:	23° ± 5 °C (73 ± 41°F)
Operating temperature:	0 ÷ 40 °C (32 ÷ 104°F)
Allowable relative humidity:	<80%HR
Storage temperature:	-10 ÷ 60°C (14 ÷ 140°F)
Storage humidity:	<70%HR

This instrument satisfies the requirements of Low Voltage Directive 2006/95/EC (LVD) and of EMC Directive 2004/108/EC

This instrument satisfies the requirements of 2011/65/EU (RoHS) directive and 2012/19/EU (WEEE) directive

7.3. ACCESSORIES PROVIDED

- Pair of test leads
- Pair of alligator clips
- Carrying bag
- Batteries
- ISO9000 calibration certificate
- User manual

8. SERVICE

8.1. WARRANTY CONDITIONS

This instrument is warranted against any material or manufacturing defect, in compliance with the general sales conditions. During the warranty period, defective parts may be replaced. However, the manufacturer reserves the right to repair or replace the product.

The warranty shall not apply in the following cases:

- Repair and/or replacement of accessories and batteries (not covered by warranty).
- Repairs that may become necessary as a consequence of an incorrect use of the instrument or due to its use together with non-compatible appliances.
- Repairs that may become necessary as a consequence of improper packaging.
- Repairs which may become necessary as a consequence of interventions performed by unauthorized personnel.
- Modifications to the instrument performed without the manufacturer's explicit authorization.
- Use not provided for in the instrument's specifications or in the instruction manual.

The content of this manual cannot be reproduced in any form without the manufacturer's authorization.

Our products are patented and our trademarks are registered. The manufacturer reserves the right to make changes in the specifications and prices due to improvements in technology.

8.2. SERVICE

If the instrument does not operate properly, please check the conditions of batteries and cables before contacting the After-sales Service and replace them, if necessary. Should the instrument still operate improperly, check that the product is operated according to the instructions given in this manual. Should the instrument be returned to the After-sales Service or to a Dealer, transport will be at the Customer's charge. However, shipment shall be agreed in advance. A report shall always be enclosed to a shipment, stating the reasons for the product's return. Use exclusively original packaging for shipment; any damage due to the use of non-original packaging material will be charged to the Customer.

9. APPENDIX – THEORETICAL OUTLINE

9.1. CALCULATION OF POWERS IN “AC 1P” MODE

The instrument measures the values of Rms Voltage and Rms Current and calculates the average Power values for each period. The formulas for power calculation are:

$$P = \frac{1}{N} \times \sum_{i=1}^N v_i \times i_i$$

$$S = \sqrt{\frac{1}{N} \times \sum_{i=1}^N v_i^2} \times \sqrt{\frac{1}{N} \times \sum_{i=1}^N i_i^2}$$

$$Q = \sqrt{S^2 - P^2}$$

$$Pf = \frac{P}{S}$$

where:

N = number of samples in the period

9.2. CALCULATION OF POWERS IN “AC 3P” MODE

The instrument measures the values of Rms Voltage and Rms Current and calculates the average Power values for each period. The formulas for power calculation are:

$$Q = \sqrt{3} \times \frac{1}{N} \times \sum_{i=1}^N v_i \times i_i$$

$$S = \sqrt{3} \times \sqrt{\frac{1}{N} \times \sum_{i=1}^N v_i^2} \times \sqrt{\frac{1}{N} \times \sum_{i=1}^N i_i^2}$$

$$P = \sqrt{S^2 - Q^2}$$

$$Pf = \frac{P}{S}$$

where:

N = number of samples in the period

9.3. CALCULATION OF POWERS IN “DC” MODE

The instrument measures the values of Avg Voltage and Avg Current and calculates the average Power value for each period. The formula for power calculation is:

$$P = \left(\frac{1}{N} \times \sum_{i=1}^N v_i \right) \times \left(\frac{1}{N} \times \sum_{i=1}^N i_i \right)$$

9.4. VOLTAGE AND CURRENT HARMONICS

Any periodic non-sinusoidal wave may be represented by a sum of sinusoidal waves, each with a frequency which is a whole multiple of the fundamental, according to the relationship:

$$v(t) = V_0 + \sum_{k=1}^{\infty} V_k \sin(\omega_k t + \phi_k) \quad (1)$$

where:

V_0 = Average value of $v(t)$

V_1 = Amplitude of the fundamental of $v(t)$

V_k = Amplitude of the k -nth harmonic of $v(t)$

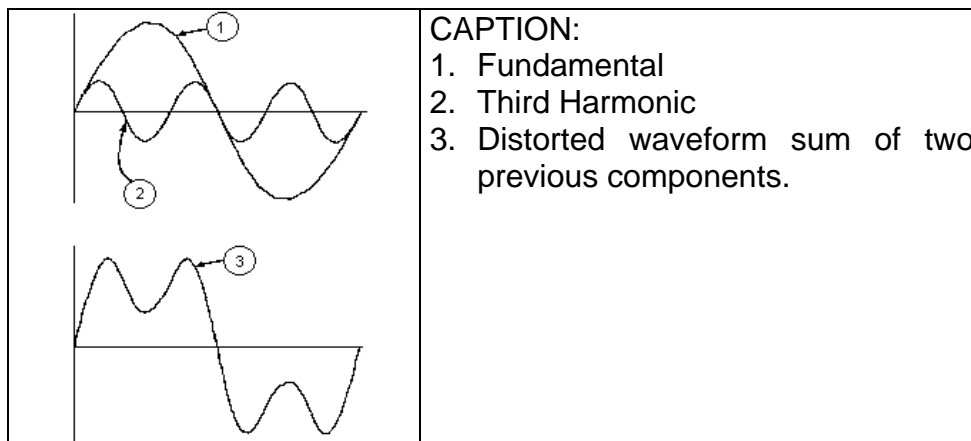

Effect of the sum of 2 multiple frequencies.

For network voltage, the fundamental has a frequency of 50 Hz, the second harmonic has a frequency of 100 Hz, the third harmonic has a frequency of 150 Hz and so on. Harmonic distortion is a continuous problem and must not be confused with short-duration phenomena such as peaks, drops or fluctuations. It can be seen from (1) that each signal consists of the sum of infinite harmonics. However, an order number exists beyond which the value of the harmonics may be considered as negligible.

A fundamental index to detect the presence of harmonics is the THD defined as:

$$THD_v = \frac{\sqrt{\sum_{h=2}^{40} V_h^2}}{V_1}$$

This index takes into consideration the presence of all harmonics, and the more distorted is the waveform, the higher is the index.

9.5. LIMIT VALUES FOR HARMONICS

Standard EN50160 prescribes the limits for the Voltage Harmonics that Energy Provider may introduce into the network.

- Under normal operating conditions, at any time in a week, 95% of the efficient values of each harmonic voltage, averaged to 10 minutes, must be lower than or equal to the values indicated in the following Table
- The total harmonic distortion (THD%) of supply voltage must be lower than or equal to 8%.

Odd Harmonics				Even Harmonics	
Not multiple of 3		Multiple of 3		Order h	Relative Voltage %Max
Order h	Relative Voltage %Max	Order h	Relative Voltage %Max		
5	6	3	5	2	2
7	5	9	1,5	4	1
11	3,5	15	0,5	6..24	0,5
13	3	21	0,5		
17	2				
19	1,5				
23	1,5				
25	1,5				

These limits, which theoretically apply only to Electric Power Suppliers, provide anyway a series of reference values within which even the harmonics put into network by users should be kept.

9.6. CAUSES FOR THE PRESENCE OF HARMONICS

- Any appliance altering the sinusoidal wave or simply using a part of such wave causes distortions to the sinusoid, and hence harmonics
- All current signals are therefore somehow virtually distorted. The most common distortion is the harmonic distortion caused by non-linear loads such as household appliances, personal computers or motor speed adjusters. Harmonic distortion generates significant currents at frequencies which are whole multiples of network voltage. **Harmonic currents have a remarkable effect on neutral conductors of electrical systems.**
- In most countries, the network voltage used is three-phase 50/60Hz, supplied by a transformer with triangle-connected primary circuit and star-connected secondary circuit. The secondary circuit generally generates 230V AC between phase and neutral and 400V AC between phase and phase. Balancing loads for each phase has always been a problem for electrical system designers.
- Approximately ten years ago, in a global balanced system, the vector sum of the currents in the neutral was zero or anyway quite low (in view of difficulty to get a perfect balance). Connected devices were incandescent lights, small motors and other devices that presented linear loads. The result was an essentially sinusoidal current in each phase and a low current on the neutral at a frequency of 50/60Hz.
- “Modern” devices such as TV sets, fluorescent lights, video machines and microwave ovens normally draw current for only a fraction of each cycle, thus causing non-linear loads and, consequently, non-linear currents. All this generates odd harmonics of the 50/60Hz line frequency. For this reason, nowadays the current in the transformers of the distribution boxes contains not only a 50Hz (or 60Hz) component, but also a 150Hz (or 180Hz) component, a 250Hz (or 300Hz) component and other significant harmonic components up to 750Hz (or 900Hz) and above.
- The vector sum of the currents in a global balanced system that feeds non-linear loads may still be quite low. However, the sum does not eliminate all harmonic currents. The odd multiples of the third harmonic (called “TRIPLENS”) are added together in the neutral conductor and can cause overheating even with balanced loads.

Consequence resulting from presence of harmonics

Generally, harmonics of even, 2nd, 4th etc. order do not create problems. Designers must consider the following points when designing a power distribution system containing harmonic currents:

Installation parts	Effects traceable to Harmonics
Fuses	Non-uniform heating of internal fuse element and consequent overheating which can also lead to an explosion of the fuse casing.
Cables	Increase in "body" effect; this means that, for cables with many wires, the internal wires have higher impedance than the external wires. As a consequence, current, which normally distributes along the external surface of the wire, produces: <ul style="list-style-type: none"> – over-heating of the conductor; – a premature degrading of the cable's insulation; – an increase in line voltage drop.
Neutral conductor	Triple harmonics, odd multiple of three, sum on neutral (instead of nullifying themselves), thus generating a potentially dangerous overheating of the conductor.
Transformers	Increase in copper loss due to a higher TRMS value of the current that circulates on internal circuits, and also due to the "body" effect on protected wires. Increase of iron loss due to hysteresis cycle distortion and due to the generation of leakage currents on the magnetic core. Heating of insulation material due to a possible DC component that can generate saturation of the magnetic core column.
Motors	Increase of loss due to overheating of internal circuits and possible damage of insulation material. The 5 th and 11 th harmonic components generate some abnormal electromagnetic coupling that can increase motor speed.
Re-phasing capacitors	Increase in "parallel resonance" present inside a circuit, due to inductive loads and re-phasing capacitors, when at least one of the harmonics has the same frequency as the resonance phenomenon. Effects of this event can be very dangerous, with explosion of used re-phasing capacitors.
RCD devices	Possible saturation of current sensing toroidal transducers resulting in malfunction, both in terms of untimely tripping and increase of the tripping threshold.
Energy disk counters	Increased rotation speed of a disk resulting in measurement errors (especially in case of low power factor loads).
Power controls switch	Reduction of electric duration of contact surfaces.
UPS	Reduced power generation from UPS.
Electronics devices	Internal damage of electronic components not protected by suitable devices.



HT INSTRUMENTS SA

C/ Legalitat, 89
08024 Barcelona - **ESP**
Tel.: +34 93 408 17 77, Fax: +34 93 408 36 30
eMail: info@htinstruments.com
eMail: info@htinstruments.es
Web: www.htinstruments.es

HT INSTRUMENTS USA LLC

3145 Bordentown Avenue W3
08859 Parlin - NJ - **USA**
Tel: +1 719 421 9323
eMail: sales@ht-instruments.us
Web: www.ht-instruments.com

HT ITALIA SRL

Via della Boaria, 40
48018 Faenza (RA) - **ITA**
Tel: +39 0546 621002
Fax: +39 0546 621144
eMail: ht@hitalia.it
Web: www.ht-instruments.com

HT INSTRUMENTS GMBH

Am Waldfriedhof 1b
D-41352 Korschenbroich - **GER**
Tel: +49 (0) 2161 564 581
Fax: + 49 (0) 2161 564 583
eMail: info@ht-instruments.de
Web: www.ht-instruments.de

HT INSTRUMENTS BRASIL

Rua Aguaçu, 171, bl. Ipê, sala 108
13098321 Campinas SP - **BRA**
Tel: +55 19 3367.8775
Fax: +55 19 9979.11325
eMail: vendas@ht-instruments.com.br
Web: www.ht-instruments.com.br

HT ITALIA CHINA OFFICE

意大利HT中国办事处
Room 3208, 490# Tianhe road, Guangzhou - **CHN**
地址 : 广州市天河路490号壬丰大厦3208室
Tel.: +86 400-882-1983, Fax: +86 (0) 20-38023992
eMail: zenglx_73@hotmail.com
Web: www.guangzhouht.com