



FULLTEST3

User manual



TABLE OF CONTENTS

1. SAFETY PRECAUTIONS AND PROCEDURES.....	3
1.1. Preliminary instructions.....	4
1.2. During use	5
1.3. After use	5
1.4. Measurement categories - Definitions	6
2. GENERAL DESCRIPTION.....	7
2.1. Function description	7
2.2. Open instrument cover	9
3. PREPARATION to USE	10
3.1. Preliminary checks	10
3.2. Power supply	10
3.3. Storage	10
4. NOMENCLATURE	11
4.1. Instrument description	11
4.2. Switch on the instrument	13
4.3. Selection measurement functions	13
5. MAIN MENU DESCRIPTION	14
5.1. Memory Menu.....	14
5.2. Operator Menu	15
5.3. Language Menu.....	15
5.4. Tester info Menu.....	16
5.5. Setup Menu	16
5.5.1. Reset Menu	18
5.5.2. EN50191 Menu.....	22
5.6. Sound Menu	23
5.7. Autotest Menu	24
6. OPERATIVE INSTRUCTIONS	27
6.1. Continuity of PE conductor – 2-Wire method (RPE-2WIRE)	27
6.1.1. Test leads calibration	28
6.1.2. Set limit value for 25A test current measurement	29
6.1.3. Anomalous situations	32
6.2. Continuity of PE conductor – 4-Wire method (RPE-4WIRE)	33
6.2.1. Set limit value	34
6.2.2. Anomalous situations	36
6.3. Insulation resistance (M Ω).....	37
6.3.1. Anomalous situations	39
6.4. Dielectric test (DIELECTRIC)	40
6.4.1. Measurement modes.....	41
6.4.2. Typology of discharge current	42
6.4.3. Safety devices	45
6.4.4. Anomalous situations	45
6.5. Test on RCD (RCD).....	46
6.5.1. Anomalous situations	49
6.6. Loop Impedance test (LOOP).....	50
6.6.1. Measurement limit value settings.....	51
6.6.2. Prospective short circuit current calculation.....	53
6.6.3. Anomalous situations	57
6.7. Global earth resistance/Contact voltage (RA \downarrow)	58
6.7.1. Limit value setting.....	58
6.7.2. Anomalous situations	60
6.8. Residual voltage (URES).....	61
6.8.1. Linear mode.....	61
6.8.2. Non-Linear mode.....	62
6.8.3. Trigger conditions.....	62
6.8.4. Anomalous situations	65
6.9. Functional test (POWER)	66

6.9.1. Anomalous situations	68
6.10. Phase sequence test (PHASESEQ)	69
6.10.1. Anomalous situations	70
6.11. Current measurement with transducer clamp (ICLAMP)	71
6.11.1. Anomalous situations	72
6.12. Leakage current (ILEAK)	73
6.12.1. Anomalous situations	76
6.13. Execution of an Autotest.....	77
7. OPERATIONS WITH THE MEMORY	79
7.1. Saving data.....	79
7.2. Saving an Autotest	81
7.3. Recall results on the display	82
8. USE OF OPTIONAL ACCESSORIES	83
8.1. Use of external keyboard.....	83
8.2. Use of barcode reader	83
8.2.1. Barcode reader configuration	84
9. UPDATING FIRMWARE OF THE INSTRUMENT	85
10. MAINTENANCE	86
10.1. General.....	86
10.2. Cleaning the instrument.....	86
10.3. Fuse replacement	86
10.4. End of life.....	87
TECHNICAL SPECIFICATIONS	88
10.5. Technical characteristics	88
10.6. General specification	95
10.7. Accessories	95
11. SERVICE	96
11.1. Warranty conditions.....	96
11.2. After-sale service	96

1. SAFETY PRECAUTIONS AND PROCEDURES



CAUTION

For your own safety and to avoid damaging the instrument follow the procedures described in this instruction manual and read carefully all notes marked with this symbol 

This instrument complies with safety Standards IEC/EN61557-1 and IEC/EN61010-1 related to electronic measuring instruments. When taking measurements:

- Avoid doing this in humid or wet places - make sure that humidity is within the limits indicated in section “Environmental conditions”
- Avoid doing this in rooms where explosive gas, combustible gas, steam or excessive dust is present
- Keep you insulated from and do not touch the object under test, any exposed metal part such as test lead ends, sockets, fixing objects, circuits etc
- Avoid doing this if you notice anomalous conditions such as breakages, deformations, fractures, blind display etc.

The following symbols are used on the instrument and in this manual:



Warning of a potential danger, comply with instruction manual.



Caution, dangerous voltage. Danger of electrical shock.

UUT Unit under test

1.1. PRELIMINARY INSTRUCTIONS



CAUTION

The instrument must be connected to **a power socket with grounded PE terminal**. If this is not assured, the instrument will display “**PE DISCONNECTED, SWITCH OFF NOW**” message and will not perform any measurement

- The instruction manual contains information and references, necessary for safe operation and maintenance of the instrument. Prior to using the instrument, the user is kindly requested to thoroughly read the instruction manual and comply with it in all sections
- Failure to read the instruction manual or to comply with the warnings and references contained herein can result in serious bodily injury or instrument damage
- In order to avoid electrical shock, the valid safety and national regulations regarding excessive contact voltages must receive utmost attention when working with voltages exceeding 60 V DC or 50 V (25 V) RMS AC. The value in brackets is valid for limited ranges (as for example medicine)
- The operator is recommended to respect the usual safety regulations aimed at protecting against dangerous currents and protecting the instrument against improper use
- This instrument has been designed for use in environments of pollution degree 2
- It can be used for tests on electrical installations of overvoltage category III, 300V maximum voltage to earth
- Do not effect measurements on circuit exceeding the specified voltage limits
- **Only the original test leads supplied along with the instrument guarantee compliance with the safety standards in force. They must be in good conditions and, if necessary, replaced with identical ones**
- Do not take measurements under environmental conditions exceeding the limits indicated in this manual
- Before connecting the test probes to the installation make sure that the right function is selected
- The instrument may only be used in dry and clean environments. Dirt and humidity reduce insulation resistance and may lead to electrical shocks, in particular for high voltages
- Never use the instrument in precipitation such as dew or rain. In case of condensation due to temperature jumps, the instrument may not be used
- Start any test series by earth bond resistance measurement
- At earth bond resistance, insulation resistance and dielectric measurements unit under test must be voltage-free. If necessary check the unit is voltage-free i.e. by using a voltage tester
- When modifying the instrument, the operational safety is no longer ensured.

1.2. DURING USE



CAUTION

An improper use may damage the instrument and/or its components or injure the operator

- Only skilled technicians, who know the possible risks involved to the dangerous voltages use are allowed to operate the instrument
- The instrument may only be connected to mains voltage as indicated on the type shield
- The instrument may only be used within the operating ranges as specified in the technical data section
- Disconnect the test leads from the circuit under test before selecting any function
- Only touch test leads and test probes at handle surface provided. Never directly touch test probes
- Never touch any unused terminal when the instrument is connected to circuits.
- Do not measure resistance in presence of external voltages; although the instrument is protected, an excessive voltage may cause malfunctioning
- **Do not open the instrument! Dangerous voltages inside**
- Connecting one terminal to the test object and working with one probe or holding both probes in one hand is prohibited
- Use safety probes with protection against contact or with two-hand operation only. Always hold only one probe in one hand
- It is prohibited to touch the unit under test during the test. If need be, additional measures must be taken (e.g. cover made of insulating mats) to protect the person performing the test against inadvertent contact with the unit under test

1.3. AFTER USE

Disconnect all test leads from the circuit under test and switch off the instrument.

1.4. MEASUREMENT CATEGORIES - DEFINITIONS

The IEC/EN61010-1 guideline (Safety requirements for electrical equipment for measurement, control and laboratory use, Part 1: General requirements) defines what a measurement category (usually called as Overvoltage Category) is. At § 6.7.4: Measuring circuits it says:

Circuits are divided into the following measurement categories:

- **Measurement category IV** is for measurements performed at the source of the low-voltage installation.
Examples are electricity meters and measurements on primary overcurrent protection devices and ripple control units.
- **Measurement category III** is for measurements performed in the building installation.
Examples are measurements on distribution boards, circuit breakers, wiring, including cables, bus-bars, junction boxes, switches, socket-outlets in the fixed installation, and equipment for industrial use and some other equipment, for example, stationary motors with permanent connection to fixed installation.
- **Measurement category II** is for measurements performed on circuits directly connected to the low voltage installation.
Examples are measurements on household appliances, portable tools and similar equipment.
- **Measurement category I** is for measurements performed on circuits not directly connected to MAINS.
Examples are measurements on circuits not derived from MAINS, and specially protected (internal) MAINS-derived circuits. In the latter case, transient stresses are variable; for that reason, the norm requires that the transient withstand capability of the equipment is made known to the user.

2. GENERAL DESCRIPTION

The FULLTEST3 is a measurement instrument used for final inspection of electrical equipment of machines, control cabinets, switchgears as well as other devices complying with IEC/EN60204-1 and IEC/EN61439-1 standards. **The followed operative instructions are relative to the IEC/EN60204-1 guideline.**

2.1. FUNCTION DESCRIPTION

<ul style="list-style-type: none"> • Continuity of protective conductor <ul style="list-style-type: none"> ➤ 2-wire or 4-wire measurement method. ➤ Compensation of test leads in case of 2-wire measurement. ➤ Open-circuit test voltage 6 V AC approx. ➤ Test current 200 mA and 25 A AC. ➤ Limit value adjustable, visual and acoustic warning in case of exceeded value 	EN61557-4 EN61439-1-§10.5.2 EN60204-1-§18.2.2 EN60598-1 EN60335-1-§27.5 EN60335-1-§A.1 EN50106 EN60950
<ul style="list-style-type: none"> • Insulation resistance <ul style="list-style-type: none"> ➤ Test voltage 100V, 250V, 500V and 1000V DC ➤ MAN (manual) mode. ➤ TIMER mode. ➤ AUTO mode. ➤ Limit value adjustable, visual and acoustic warning in case of exceeded value. 	EN61557-2 EN61439-1-§11.9 EN60204-1 EN60598-1
<ul style="list-style-type: none"> • Dielectric test <ul style="list-style-type: none"> ➤ Adjustable test voltage 250 V up to 5100 V AC. ➤ Trip out current adjustable 1 ÷ 110 mA, visual and acoustic warning in case of exceeded limit value. ➤ Display and trip out based on real or apparent current. ➤ MANUAL mode ➤ RAMP 75% mode (predefined automatic rising of test voltage). ➤ RAMP 50% mode (predefined automatic rising of test voltage) ➤ BURN mode ➤ PULSE mode ➤ Protection against unauthorised use (safety measure). ➤ Red warning lamp connector (safety measure). ➤ Safety input connector (safety measure). 	EN61439-1-§9.1 EN60204-1-§18.4 EN60598-1 EN60335-1-§13.3 EN60335-1-§A.2 EN50191
<ul style="list-style-type: none"> • Loop impedance measurement <ul style="list-style-type: none"> ➤ ZL/N, ZL/L and ZL/PE measurement. ➤ Voltage range 100 ÷ 460 V. ➤ IPSC calculation. ➤ Limit value adjustable, visual and acoustic warning in case of exceeded value. 	EN60204-1-§18.2 EN61557-3
<ul style="list-style-type: none"> • Phase sequence <ul style="list-style-type: none"> ➤ Mains voltages UL1/2, UL2/3, UL3/1 simultaneously displayed. 	EN61557-7

<ul style="list-style-type: none"> • RCD test <ul style="list-style-type: none"> ➤ AC, A and B type. ➤ General, selective and delayed characteristic. ➤ Voltage range 100 ... 265 V. ➤ Limit contact voltage 25 or 50 V. ➤ $I_{\Delta N} = 10, 30, 100, 300, 500, 650$ or 1000 mA. ➤ Trip out time at $I_{\Delta N}/2$ (AC, A and B type). ➤ Trip out time at $I_{\Delta N}$ (AC, A and B type). ➤ Trip out time at $2I_{\Delta N}$ (AC and A type). ➤ Trip out time at $5I_{\Delta N}$ (AC and A type) or at $4I_{\Delta N}$ (B type). ➤ Ramp test (AC, A and B type). ➤ AUTO test (AC, A and B type). ➤ Visual and acoustic warning in case of exceeded limit value. 	EN61557-6
<ul style="list-style-type: none"> • Global earth resistance without RCD's tripping <ul style="list-style-type: none"> ➤ Selectable test current with regard to involved RCD. ➤ $I_{\Delta N} = 10, 30, 100, 300, 500, 650$ or 1000mA. ➤ Measurement with $I_{\Delta N}/2$ (without tripping out RCD) ➤ Voltage range $100 \div 265$ V. ➤ Contact voltage UC measured during the measurement. ➤ Limit value (RA) fixed to 25 or 50 V/$I_{\Delta N}$, visual and acoustic warning in case of exceeded value. 	
<ul style="list-style-type: none"> • Residual voltage <ul style="list-style-type: none"> ➤ Measurement on power plug (2-wire method). ➤ Measurement on internal components (4-wire method). ➤ Limit discharge time 1 s or 5 s. ➤ LINEAR or NONLINEAR mode. ➤ Visual and acoustic warning in case of exceeded limit value. 	EN60204-1-§18.5
<ul style="list-style-type: none"> • Functional tests (on test socket) <ul style="list-style-type: none"> ➤ Apparent power PAPP. ➤ Real power P. ➤ Mains voltage UL/N. ➤ Load current IL. ➤ Power factor PF. ➤ Leakage current IPE (differential method). ➤ Internal phase position exchange. ➤ Limit value (apparent power) adjustable, visual and acoustic warning in case of exceeded value. 	
<ul style="list-style-type: none"> • AC Current with external clamp (optional) <ul style="list-style-type: none"> ➤ Measurement in combination with HT96U current clamp. ➤ Three ranges 1 A, 100 A and 1000 A. ➤ Limit value adjustable, visual and acoustic warning in case of exceeded value. 	

<ul style="list-style-type: none"> • Leakage current <ul style="list-style-type: none"> ➤ Measurement of IPE current on schuko socket (differential method). ➤ Measurement with current clamp type HT96U, three ranges 1 A, 100 A and 1000 A. ➤ Limit value adjustable, visual and acoustic warning in case of exceeded value. 	
<ul style="list-style-type: none"> • General specifications <ul style="list-style-type: none"> ➤ Portable Machinery & Panel Tester constructed according to the IEC/EN60204-1 and IEC/EN61439-1 standards ➤ Operation system WINDOWS EMBEDDED COMPACT 7 supports all measurements and operations ➤ Easy and clear operation by using the touch screen and intuitive hard keys ➤ TRMS measurements ➤ Data memory for 999 measurement results ➤ AUTEOTEST feature ➤ Real time clock included. ➤ Integrated interface (USB 2.0) for transfer of measurement results to PC ➤ Separate interface (USB 2.0) for connection of USB barcode reader, USB keyboard, USB memory stick, printer or IMP57-impedance tester. ➤ Graphic touch screen 102×60 mm, 480×272 dots. ➤ Compact housing with external accessory bag. ➤ Quick connection diagrams and limit values under the instrument cover ➤ Fuse protection in case of overload ➤ PC Software TOPVIEW available ➤ Complete test accessories included. ➤ Bluetooth communication ➤ Remote START/STOP and SAVE function. 	

2.2. OPEN INSTRUMENT COVER

The instrument is built in a robust plastic case that allows comfortable transport. We recommend the user to follow the next opening instructions:

1. Place the unit on to a hard horizontal surface
2. Press on the case cover with your hands, see the mark 1
3. Unlock the fixing hooks of the cover, see the mark 2
4. Open the cover into vertical position

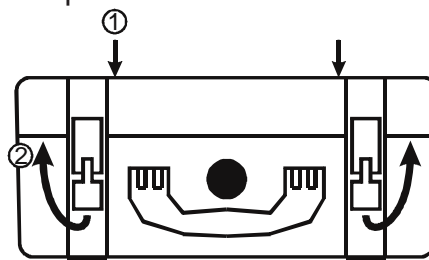

Fig. 1 : Opening the instrument's cover

3. PREPARATION TO USE

3.1. PRELIMINARY CHECKS

This instrument was checked both mechanically and electrically prior to shipment. All possible cares and precautions were taken to let you receive the instrument under perfect conditions. Notwithstanding we suggest you to check it rapidly (possible damages may have occurred during transport – if so please contact the local distributor from whom you purchased the item). Make sure all standard accessories according to Packing List are included. Should you have to return back the instrument for any reason please follow the instructions mentioned in § 3.4

3.2. POWER SUPPLY

Earthed plugs must energize the instrument. To avoid any risk the instrument does not allow to effect measurements when there is not such a connection (see § 4.2).



CAUTION

The instrument include EMC/EMI filters which could trip RCD with 30mA nominal current. It is recommended to power supply the instrument through a mains protected by a RCD of 100mA (or higher) nominal current

3.3. STORAGE

In order to guarantee precise measurement, after a long storage time, wait for the instrument to come back to normal condition (see § 10.6).

4. NOMENCLATURE

4.1. INSTRUMENT DESCRIPTION

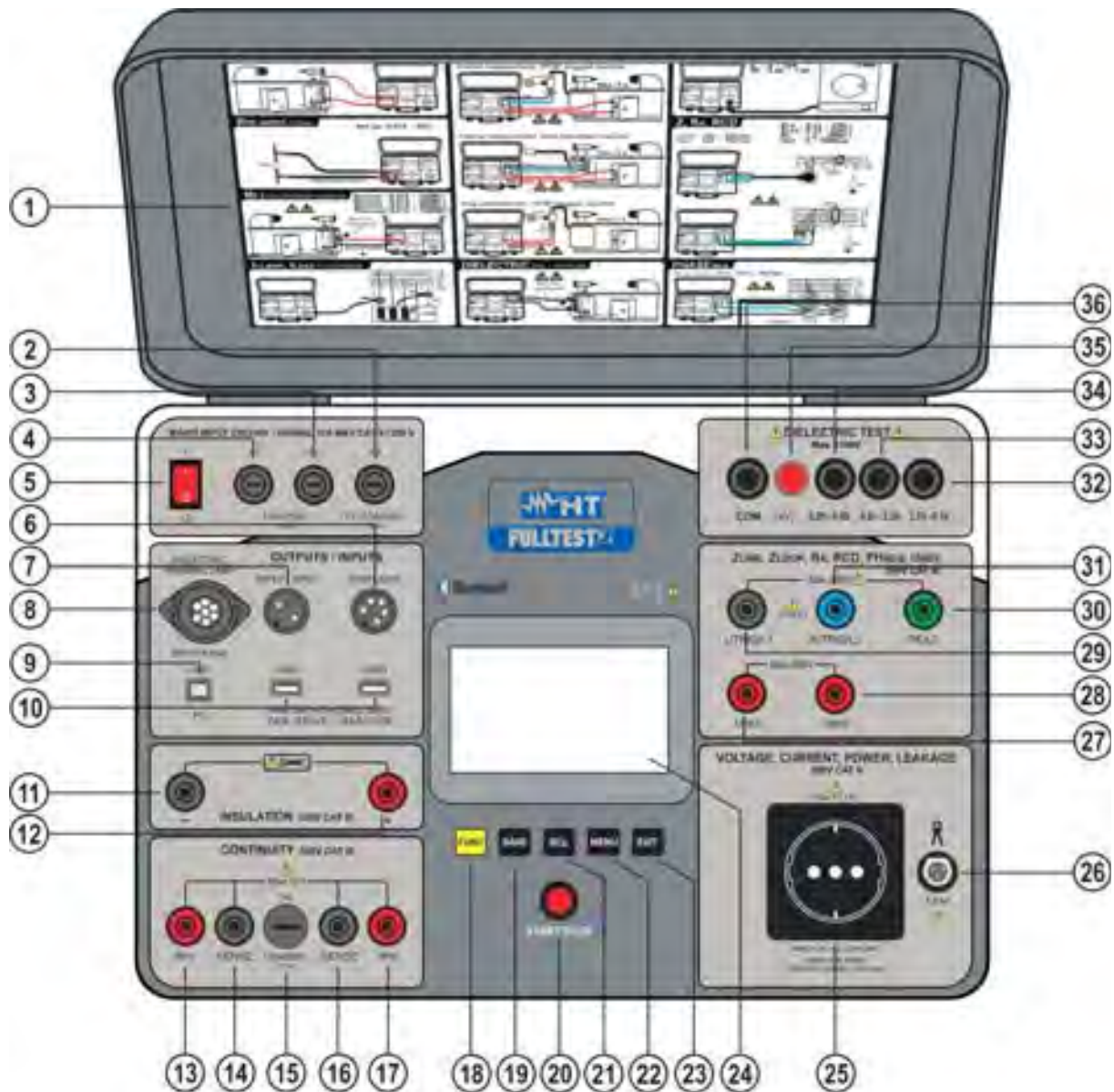

Fig. 2 : Instrument description

CAPTION

1. Quick instruction label under the cover
2. Fuse **F3** – Protection LOOP, RA, RCD measurements
3. General tester fuse **F2** – Protection POWER, RPE and DIELECTRIC measurements
4. General tester fuse **F1** - Protection POWER, RPE and DIELECTRIC measurements
5. **ON/OFF** mains switch
6. Connector for **START/SAVE** remote control adapter (optional accessory **FT3RMTCT**)
7. Connector **SAFETY INPUT** for connection of external safety switch (optional accessory **FT3SFTSW**). **It disables DIELECTRIC tests in case the switch is open**

8. IEC female connector for connection of warning lamp in DIELECTRIC test (optional accessory **FT3R-GLP**)
9. **USB1** connector for connection with PC
10. **USB2** and **USB3** connectors for connection of USB stick, USB barcode reader (optional accessory **FT3BARCR**), USB printer (optional accessory **FT3MPT2**), USB keyboard (optional accessory **FT3KBDEN**) or Loop/Line impedance meter with high resolution (optional accessory **IMP57**)
11. Negative **RINS** terminal
12. Positive **RINS** terminal
13. **RPE** current generator terminal
14. **SENSE** voltage terminal for RPE 4-wire test
15. Fuse **F4** – Protection in RPE measurement.
16. **SENSE** voltage terminal for RPE 4-wire test
17. **RPE** current generator terminal
18. **FUNC** hard key to select measurement function
19. **SAVE** hard key to save test result
20. **START/STOP** button which starts or stops selected measurement
21. **RCL** hard key to recall saved result
22. **MENU** hard key to open Main Menu
23. **EXIT** hard key to exit existing screen and return it one step back.
24. Color LCD touch-screen display
25. Mains test socket for POWER and LEAKAGE measurement.
26. CLAMP connector for optional accessory HT96 current clamp
27. **URES** measurement terminal
28. **URES** measurement terminal
29. **L/TRIG/L1** terminal for LOOP, RA, RCD, PHASE SEQUENCE and URES measurements
30. **PE/L3** terminal for LOOP, RA, RCD and PHASE SEQUENCE measurements
31. **N/TRIG/L2** terminal for LOOP, RCD, PHASE SEQUENCE and URES measurements
32. DIELECTRIC test terminal for test voltages 2.51 ÷ 5.10 kV
33. DIELECTRIC test terminal for test voltages 0.81 ÷ 2.50 kV
34. DIELECTRIC test terminal for test voltages 0.25 ÷ 0.80 kV
35. DIELECTRIC on lamp. It lights when DIELECTRIC test is running
36. DIELECTRIC COM (common) test terminal.

4.2. SWITCH ON THE INSTRUMENT

1. Connect the instrument to a 230V 50/60Hz mains socket **with PE terminal**
2. Switch on the instrument by press **ON/OFF** key (see Fig. 2 – part 5)
3. The instrument performs the firmware upload (approx. 30s) and the last used measurement screen is shown at display. An acoustic sound will be given as soon as the tester is ready for measurements.



CAUTION

In case energizing socket is not earthed properly PE DISCONNECTED message will appear and the tester will not perform any further operation. In this case switch off the tester immediately and check the energizing socket

4.3. SELECTION MEASUREMENT FUNCTIONS

1. Press **FUNC** key. The below screens will appear.

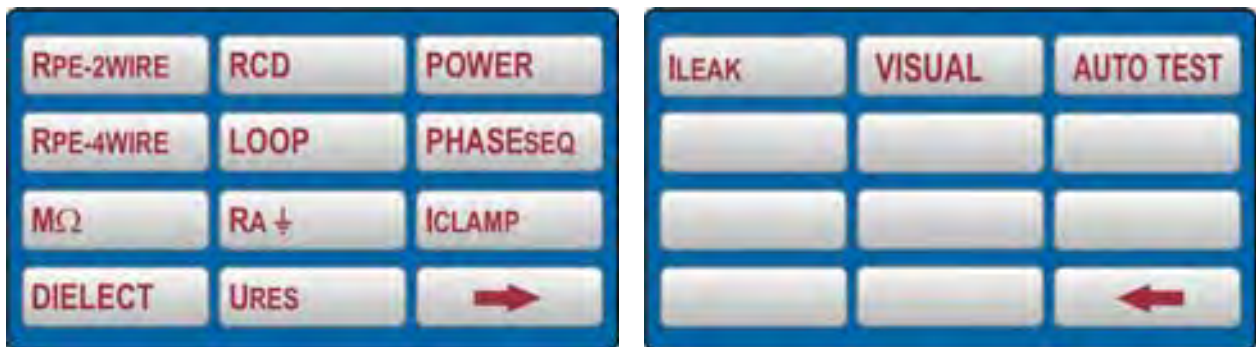

Fig. 3 : Function selection screens

2. Select function by pressing appropriate touch-screen key. Basic measurement screen of selected function will appear (e.g. RPE-2WIRE basic measurement screen below)

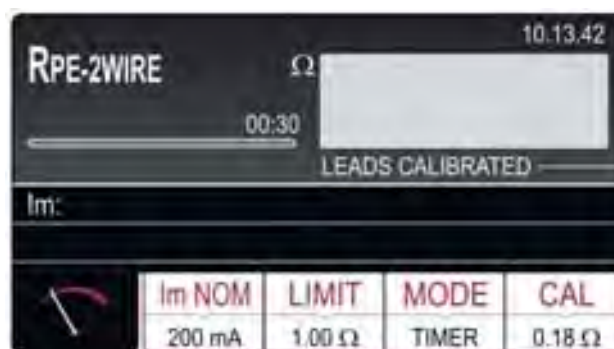

Fig. 4 : Basic measurement screen in RPE-2WIRE function

5. MAIN MENU DESCRIPTION

For further selection, entry and display of instrument's settings press the **MENU** hard key, the following MAIN MENU will appear.

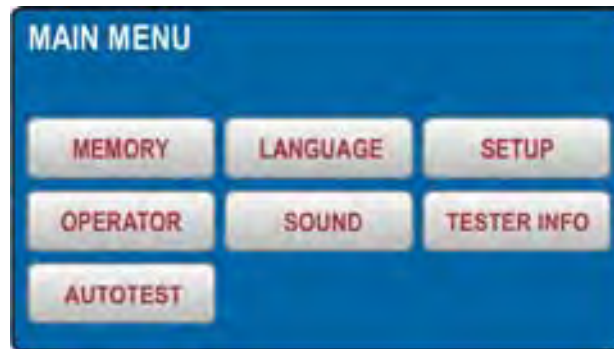

Fig. 5 : MAIN MENU screen

Press wished submenu touch-screen key for further settings.

5.1. MEMORY MENU

Inside this section there are the below sub-menus:

- MEM INFO → allows to show the number of occupied and total memory location (max 999). Each measurement result is saved inside a memory location
- CLEAR → allows to delete data saved inside memory. It is possible to delete all memory (TOTAL), the last saved data (LAST RESULT) or the unused AUTOTEST (see § 6.13). Confirm the operation by pressing the virtual key **YES**
- USB → allows to transfer the saved data into a USB stick. Insert the USB stick in the USB2 or USB3 port and press the USB virtual key. Confirm the operation press YES key

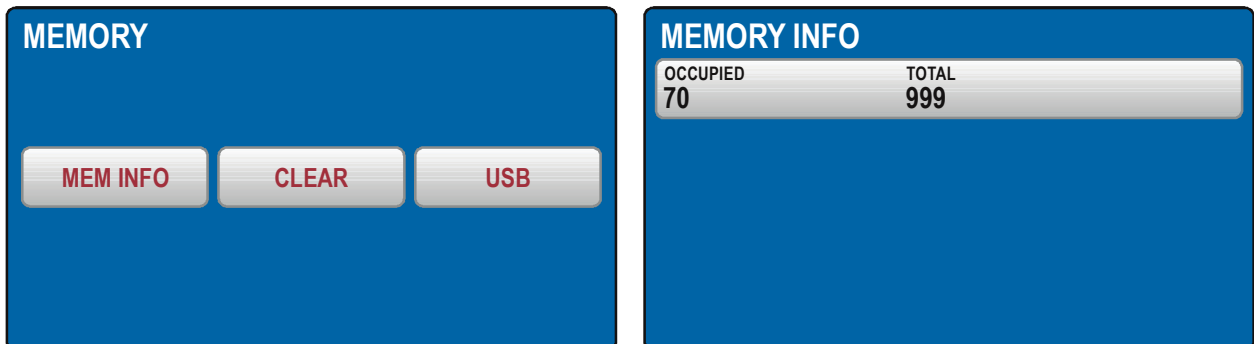

Fig. 6 : MEMORY Menu



Fig. 7 : CLEAR Menu

5.2. OPERATOR MENU

In this section is possible to define the name of the operator who will be included inside the final report of the data transferred to PC.



Fig. 8 : OPERATOR Menu

- Check the list of available operators by using the ▼ and ▲ touch-screen keys (if there are more than 4 operators entered)
- Select wished operator by pressing the operator’s touch-screen key, e.g. **Default**. Marked operator is selected and will be used during the measurements.
- Press the **ENTER** touch-screen key to confirm the selection and to exit the OPERATOR menu, MAIN MENU will be displayed again.

How to add a new operator

1. Open OPERATOR menu and press the **ADD NEW** touch-screen key. The screen of Fig. 8 – right side will be shown
2. Create new operator’s name. Use the **123 / ABC** key to select figure or character selection screen
3. Confirm entered name by pressing the **ENTER** touch-screen key. OPERATOR screen will appear again and last entered operator will be selected

How to delete an operator

1. Open OPERATOR menu, select the operator you wish to delete and press the **DELETE** touch-screen key. Confirm the deletion by pressing the **YES** touch-screen key.

5.3. LANGUAGE MENU

Select wished language by pressing appropriate touch-screen key, the menu will turn to MAIN MENU



Fig. 9 : LANGUAGE Menu

5.4. TESTER INFO MENU

TESTER INFO menu displays basic data of the tester like firmware version, hardware version, serial number and catalog number



Fig. 10 : TESTER INFO Menu

5.5. SETUP MENU

In this section is possible to set the values of the parameters used in the measurements performed by the instrument. The below screen is shown



Fig. 11 : SETUP Menu

The below options are available :

- **LEVEL NAMES** → Up to 3 levels are available when saving test results **LEVEL1**, **LEVEL2** and **LEVEL3**. The operator can rename (**max 12 characters**) them freely by using the virtual keyboard (see Fig. 12) and can be used during the saving measurement data after the pressing od **SAVE** key (see § 7.1)

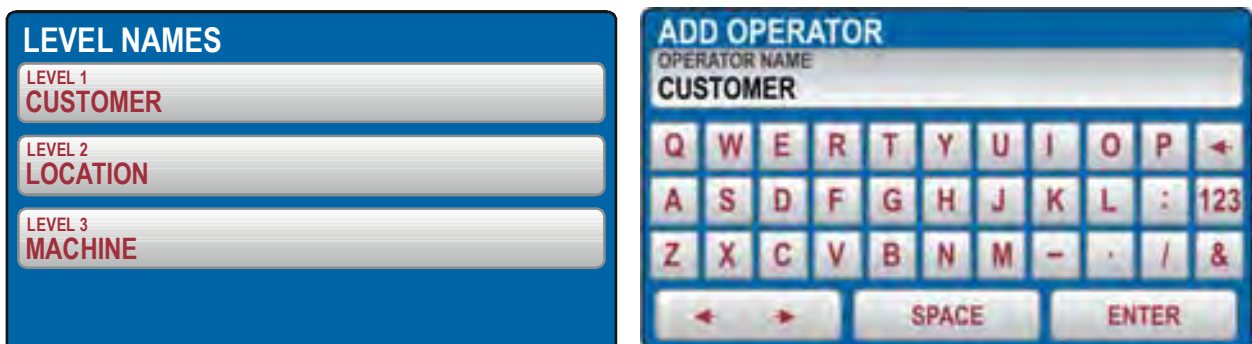

Fig. 12 : LEVEL NAMES Menu

- **DATE/TIME** → In order to set date and time DATE/TIME menu shall be used. Enter actual date and time by using the ←, → and 0 ... 9 keys. Confirm it by pressing the **ENTER** touch-screen key. Time starts to run on this confirmation



Fig. 13 : DATE/TIME Menu

- **CONTACT VOLTAGE** → This menu shall be used in order to select limit contact voltage which is used in RCD and in RA measurements. The voltage may be either 25 or 50V.

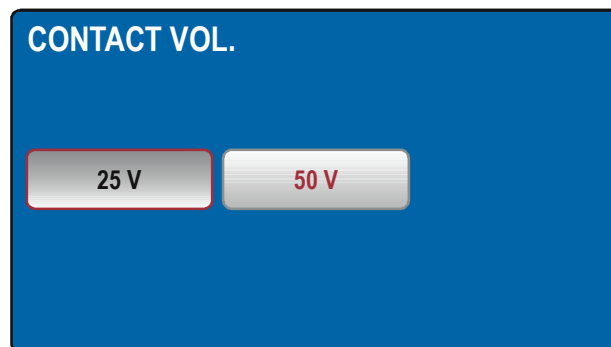

Fig. 14 : CONTACT VOL Menu

- **NOMINAL VOLTAGE** → This menu shall be used in order to select nominal mains voltage used in LOOP and URES measurements. In LOOP measurements it is used for calculation of prospective short-circuit current, see the “LOOP IMPEDANCE / SHORT-CIRCUIT CURRENT (LOOP)” section. In URES function (linear mode only) the nominal voltage is used for scaling of measured value, see the “RESIDUAL VOLTAGE (URES)” section.

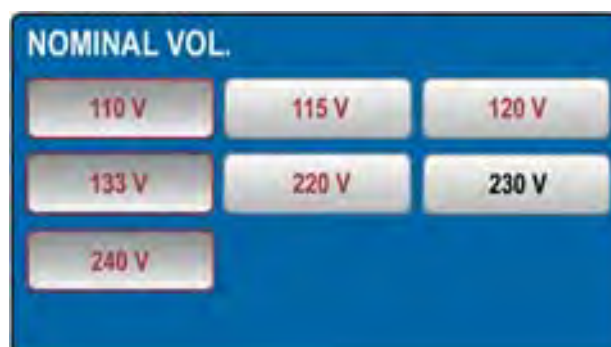

Fig. 15 : NOMINAL VOL Menu

5.5.1. Reset Menu

There are many adjustable parameters in the FULLTEST3 tester. If an operator due to any reason wishes to reset all adjustable parameters to factory-set values, the operation can be done by using the RESET menu. Confirm RESET operation by pressing the **YES** touch-screen key or press the **EXIT** hard key to exit the menu. Turn the tester off and on again by using the ON/OFF mains switch. **The Reset operation DOES NOT delete the data saved inside the memory**

Function	Parameter
GENERAL	<ul style="list-style-type: none"> - OPERATOR = Default - LANGUAGE = ITALIAN - CONTACT VOLTAGE = 50 V - NOMINAL VOLTAGE = 230 V - SAFETY INPUT = ENABLED - SOUND = ON
RPE-2WIRE	<ul style="list-style-type: none"> - I_m NOM = 200 mA - LIMIT value (200 mA) = 0.30 Ω - MODE = MANUAL - CAL (200 mA) = 0.00 Ω - LIMIT value 1 (200 mA) = 0.30 Ω - LIMIT value 2 (200 mA) = 1.00 Ω - LIMIT value 3 (200 mA) = 5.00 Ω - LIMIT value 4 (200 mA) = 50.0 Ω - LIMIT mode (25 A) = STANDARD - LIMIT value (25 A, STANDARD limit mode) = 0.30 Ω - LIMIT value 1 (25 A, STANDARD limit mode) = 0.30 Ω - LIMIT value 2 (25 A, STANDARD limit mode) = 1.00 Ω - LIMIT value 3 (25 A, STANDARD limit mode) = 5.00 Ω - LIMIT value 4 (25 A, STANDARD limit mode) = 10.0 Ω - LENGTH = 2 m - LENGTH 1 = 2 m - LENGTH 2 = 3 m - LENGTH 3 = 10 m - LENGTH 4 = 100 m - SECTION = 1 mm² - SECTION 1 = 1 mm² - SECTION 2 = 2.5 mm² - SECTION 3 = 10 mm² - SECTION 4 = 35 mm² - MAT. = Cu - ZLINE = 0.100 Ω - ZLINE 1 = 0.100 Ω - ZLINE 2 = 0.300 Ω - ZLINE 3 = 0.500 Ω - ZLINE 4 = 1.000 Ω - PROTECTION = MCB B - IN (any protection) = 6 A - IN (any protection) 1 = 6 A - IN (any protection) 2 = 16 A - IN (any protection) 3 = 25 A - IN (any protection) 4 = 32 A - TIMER = 3 s - TIMER 1 = 3 s - TIMER 2 = 10 s - TIMER 3 = 30 min - TIMER 4 = 60 min - CAL (25 A) = 0.000 Ω

RPE-4WIRE	<ul style="list-style-type: none"> - LIMIT value (STANDARD limit mode) = 0.300 Ω - MODE → MANUAL - LIMIT value 1 (STANDARD limit mode) = 0.300 Ω - LIMIT value 2 (STANDARD limit mode) = 1.000 Ω - LIMIT value 3 (STANDARD limit mode) = 5.00 Ω - LIMIT value 4 (STANDARD limit mode) = 10.00 Ω - LENGTH = 2 m - LENGTH 1 = 2 m - LENGTH 2 = 3 m - LENGTH 3 = 10 m - LENGTH 4 = 100 m - SECTION = 1 mm² - SECTION 1 = 1 mm² - SECTION 2 = 2.5 mm² - SECTION 3 = 10 mm² - SECTION 4 = 35 mm² - MAT. = Cu - Z LINE = 0.100 Ω - ZLINE 1 = 0.100 Ω - ZLINE 2 = 0.300 Ω - ZLINE 3 = 0.500 Ω - ZLINE 4 = 1.000 Ω - PROTECTION = MCB B - IN (any protection) = 6 A - IN (any protection) 1 = 6 A - IN (any protection) 2 = 16 A - IN (any protection) 3 = 25 A - IN (any protection) 4 = 32 A - TIMER = 3 s - TIMER 1 = 3 s - TIMER 2 = 10 s - TIMER 3 = 30 min - TIMER 4 = 60 min
RISO	<ul style="list-style-type: none"> - MODE = MANUAL - Um NOM = 500 V - LIMIT value = 0.25 MΩ - TIMER = 5 s - TIMER 1 = 5 s - TIMER 2 = 10 s - TIMER 3 = 1 min - TIMER 4 = 10 min - LIMIT value 1 = 0.25 MΩ - LIMIT value 2 = 0.30 MΩ - LIMIT value 3 = 1.00 MΩ - LIMIT value 4 = 2.00 MΩ

DIELECTRIC	<ul style="list-style-type: none"> - MODE = MANUAL - UTEST NOM = 250 V - LIMIT value = 1 mA - CHAR = IAPP - UTEST NOM 1 = 250 V - UTEST NOM 2 = 1000 V - UTEST NOM 3 = 2500 V - UTEST NOM 4 = 3500 V - RAMP TIMER = 10 s - RAMP TIMER 1 = 10 s - RAMP TIMER 2 = 30 s - RAMP TIMER 3 = 1 min - RAMP TIMER 4 = 10 min - LIMIT value 1 = 1 mA - LIMIT value 2 = 10 mA - LIMIT value 3 = 50 mΩ - LIMIT value 4 = 100 mA
RCD	<ul style="list-style-type: none"> - TYPE = AC GEN - I_{ΔN} = 30 mA - MEAS = t/I_{ΔN} - POL = POS - DELAY = 100 ms - DELAY 1 = 100 ms - DELAY 2 = 200 ms - DELAY 3 = 300 ms - DELAY 4 = 700 ms
LOOP	<ul style="list-style-type: none"> - MODE = LOOP L/N - LIMIT mode = STD - I_b = 1 kA - I_b 1 = 1 kA - I_b 2 = 3 kA - I_b 3 = 6 kA - I_b 4 = 25 kA - PROTECTION = MCB B - I_N (any protection) = 6 A - I_N (any protection) 1 = 6 A - I_N (any protection) 2 = 16 A - I_N (any protection) 3 = 25 A - I_N (any protection) 4 = 32 A - MAT. = Cu - COATING = PVC - SECTION = 1 mm² - SECTION 1 = 1 mm² - SECTION 2 = 2.5 mm² - SECTION 3 = 10 mm² - SECTION 4 = 35 mm² - N = 1 - N 1 = 1 - N 2 = 10 - N 3 = 50 - N 4 = 75 - TSET = 0.2 s
RA	<ul style="list-style-type: none"> - Nominal differential current I_{ΔN} = 30 mA
URES	<ul style="list-style-type: none"> - CONNECTION = PLUG - MODE = LINEAR - LIMIT t = 5 s

POWER	<ul style="list-style-type: none"> - TIMER = 10 s - LIMIT apparent power = 6 VA - L POS = RIGHT - TIMER 1 = 10 s - TIMER 2 = 30 s - TIMER 3 = 1 min - TIMER 4 = 10 min - LIMIT apparent power 1 = 6 VA - LIMIT apparent power 2 = 100 VA - LIMIT apparent power 3 = 1.00 kVA - LIMIT apparent power 4 = 5.06 kVA
PHASE ROTATION	<ul style="list-style-type: none"> - None
ICLAMP	<ul style="list-style-type: none"> - RANGE = 1000 mA - LIMIT value (range 1000 mA) = 3.5 mA - LIMIT value 1 (range 1000 mA) = 3.5 mA - LIMIT value 2 (range 1000 mA) = 10.0 mA - LIMIT value 3 (range 1000 mA) = 100 mA - LIMIT value 4 (range 1000 mA) = 1000 mA - LIMIT value (range 100.0 A) = 6.0 A - LIMIT value 1 (range 100.0 A) = 6.0 A - LIMIT value 2 (range 100.0 A) = 16.0 A - LIMIT value 3 (range 100.0 A) = 50.0 A - LIMIT value 4 (range 100.0 A) = 100.0 A - LIMIT value (range 1000 A) = 6 A - LIMIT value 1 (range 1000 A) = 6 A - LIMIT value 2 (range 1000 A) = 160 A - LIMIT value 3 (range 1000 A) = 500 A - LIMIT value 4 (range 1000 A) = 1000 A
ILEAK	<ul style="list-style-type: none"> - MODE = CLAMP - RANGE = 1000 mA - LIMIT value (range 1000 mA) = 3.5 mA - LIMIT value 1 (CLAMP range 1000 mA) = 3.5 mA - LIMIT value 2 (CLAMP range 1000 mA) = 10.0 mA - LIMIT value 3 (CLAMP range 1000 mA) = 100 mA - LIMIT value 4 (CLAMP range 1000 mA) = 1000 mA - LIMIT value (CLAMP range 100.0 A) = 6.0 A - LIMIT value 1 (CLAMP range 100.0 A) = 6.0 A - LIMIT value 2 (CLAMP range 100.0 A) = 16.0 A - LIMIT value 3 (CLAMP range 100.0 A) = 50.0 A - LIMIT value 4 (CLAMP range 100.0 A) = 100.0 A - LIMIT value (CLAMP range 1000 A) = 6 A - LIMIT value 1 (CLAMP range 1000 A) = 6 A - LIMIT value 2 (CLAMP range 1000 A) = 160 A - LIMIT value 3 (CLAMP range 1000 A) = 500 A - LIMIT value 4 (CLAMP range 1000 A) = 1000 A - LIMIT value (SOCKET) = 3.50 mA - LIMIT value 1 (SOCKET) = 3.50 mA - LIMIT value 2 (SOCKET) = 10.00 mA - LIMIT value 3 (SOCKET) = 1.0 A - LIMIT value 4 (SOCKET) = 10.0 A

5.5.2. EN50191 Menu



CAUTION

The “EN50191” menu is available only for instrument with FW version B30.Mxx.Vxx or higher

In order to select the status of safety level in DIELECTRIC function the **EN50191** menu shall be used (it replace “old” SAFETY” button). The operation according to EN50191 guideline may be enabled or disabled. **This safety level status does not influence any other function except DIELECTRIC**



DISCLAIMER

- Since the instrument could be used for applications where EN50191 isn't required, the instrument is delivered with this option **DISABLED**
- The user is warned to enable this option if his test procedure require additional safety precautions (typically when test current is $\geq 3\text{mA}$)
- The producer declines any responsibility if the EN50191 option isn't correctly set according to safety procedures

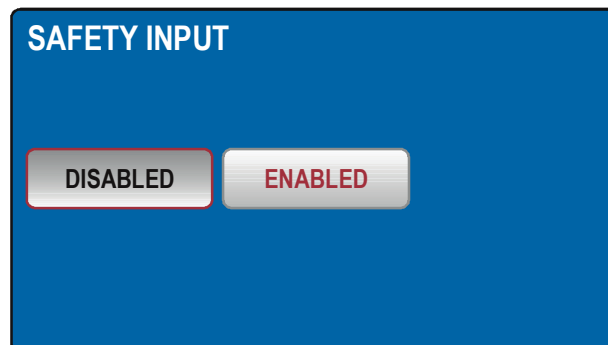

Fig. 16 : SAFETY INPUT Menu

Operation according to EN50191 standard is enabled: DIELECTRIC function is accessible only if the operator enter the (not modified) **8314** password and (for test voltage $\geq 100\text{V}$) the “SAFETY INPUT” contact is closed. The password is required only during the execution of the first dielectric test after switch on or the enabled of EN50191 parameter.

Operation according to EN50191 standard is disabled: DIELECTRIC function is accessible regardless of safety input condition (safety switch may be closed or open or not connected at all) and no entry password is required when starting the DIELECTRIC test.

NOTE

The EN50191 regulation also provides, when performing dielectric strength tests, the restriction of testing area of the on access and use of lamps for the reporting of hazardous conditions. In this regard the following optional accessories are available:

- **FT3SFTSW** → safety contact (with connector and cable) to fix at the door of testing area zone
- **FT3R-GLP** → Red/Green Warning Lamp for FULLTEST3 with Hardware 70 or higher (from S/N: **16101107**)
- **FT3REDLP** → Red Warning Lamp for FULLTEST3 with Hardware version lower Hardware 70

In order to set the status of safety input in DIELECTRIC function the SAFETY INPUT menu shall be used. The safety input may be enabled or disabled. Safety input disabled: DIELECTRIC test is active regardless of the safety input condition (safety switch may be closed or opened or not connected at all). Safety input enabled: DIELECTRIC test is active only if safety input condition is sufficient (safety switch must be closed). This safety input status does not influence to any other function except DIELECTRIC.

5.6. SOUND MENU

In order to turn the acoustic signals off/on SOUND menu shall be used.

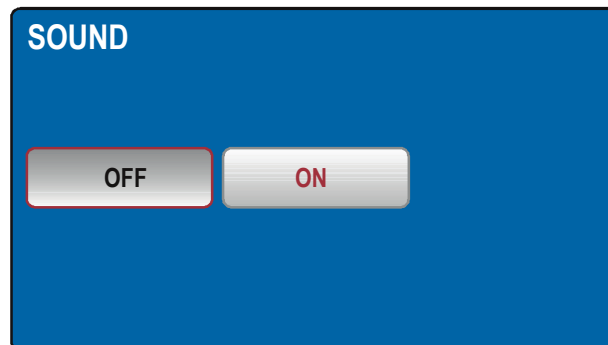

Fig. 17 : SOUND Menu

5.7. AUTOTEST MENU

The AUTO TEST menu allows to define custom test groups (called Autotest), of the same type or different (**max 8 tests for each Autotest**), which can be activated one after the other through the **START/STOP** key sequentially by the operator without having to call up the measurement function each time. **It is possible to define an indefinite number of Autotests until the internal memory is filled.** The typical fields of application of this function are:

- Rapid execution of repetitive tests of the same type
- End-of-line checks on machines

How to define an Autotest

1. Press the **MENU** key and touch the AUTO TEST icon. The following screen is shown on the display



Fig. 18 : AUTOTEST Menu

2. Press the **ADD NEW** button to add a new Autotest. The following screen is shown on the display



Fig. 19 : AUTOTEST Menu – Add new Autotest

3. Enter the name of the Autotest (**max 9 characters**) using the virtual keyboard and confirm with **ENTER**. The new Autotest will be added to the list sequentially

How to include tests inside an Autotest

4. Press the **EDIT** key to open the selected Autotest and include the desired test groups (**max 8 tests**) or to modify an existing one (see § Fig. 20)

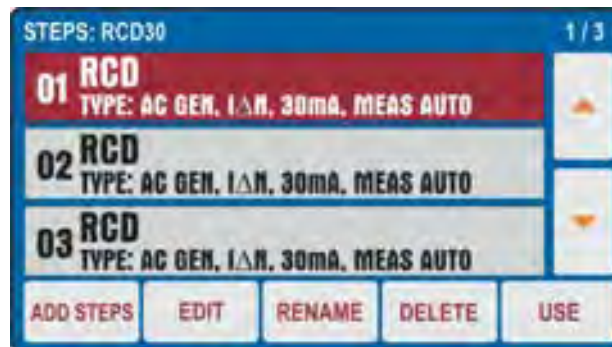

Fig. 20 : AUTOTEST Menu – Including tests inside an Autotest

5. Press the **ADD STEPS** key or touch the selected Autotest to add a test. The instrument proposes the screen of Fig. 21 - left side



Fig. 21 : AUTOTEST Menu – Including tests inside an Autotest

6. Touch the test to be include (ex: RCD) noting the presence of the number of tests currently included in the Autotest (ex: 3). The instrument shows the screen of the selected function (see Fig. 21 - right side). Perform the desired programming and touch the **ADD** key to add the test
7. Repeat the same steps to add up to 8 tests and touch the **FINISH** button (see Fig. 21 - left side) to finish the inclusion. Note the Autotest update
8. Touch the **EDIT** key to modify the parameters of the selected test. The following screen is shown on the display



Fig. 22 : AUTOTEST Menu – Modified test to add the Autotest

9. Make the desired changes and touch the **FINISH** key to return to the previous screen
10. Touch the **RENAME** key to rename the Autotest name
11. Touch the **DELETE** key to cancel the selected test within the Autotest
12. Touch the **USE** key to run the Autotest (see §)

How to copy an Autotest

13. Select an Autotest and touch the **COPY** key (see Fig. 23). The following screen is shown on the display



Fig. 23 : AUTOTEST Menu – Copy an Autotest

14. Rename the Autotest and confirm with the **ENTER** key to add the new one to the list

How to include a Visual message

Inside a sequence of Autotests it is possible to include a "Visual" message relative to the final result of the set of tests performed (Passed/Failed test). Proceed as follows:

15. Press the **ADD STEPS** key or touch the selected Autotest to add a test. The instrument shows the screen of Fig. 21 - left side. Touch the **VISUAL** key. The following screen is shown on the display

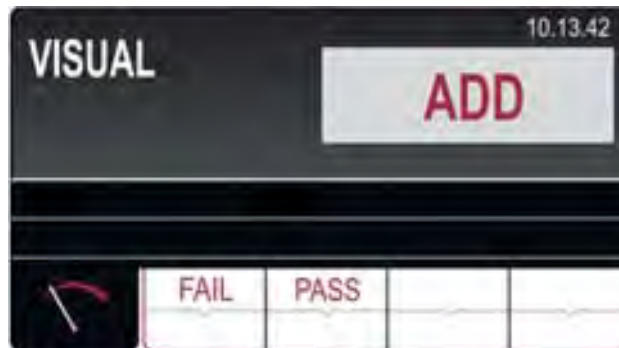

Fig. 24 : AUTOTEST Menu – Add a Visual message

16. Touch the **ADD** key to add the **OK (PASS)** or **NO OK (FAIL)** message to the selected Autotest. This message will be present at the end of the Autotest execution (see §)

How to delete an Autotest

17. Select an Autotest and tap the **DELETE** button (see Fig. 18). The instrument provides a confirmation message before executing the operation



CAUTION

An Autotest can be deleted only if there are **NO** results saved in the memory of the instrument due to the execution of the same. In this case, the instrument provides a message on the display

6. OPERATIVE INSTRUCTIONS

6.1. CONTINUITY OF PE CONDUCTOR – 2-WIRE METHOD (RPE-2WIRE)

Complying with IEC/EN60204-1 the continuity of protective bonding circuit between PE terminal and relevant points of the protective conductor system must be checked by injecting a measurement current of 0.2 A up to 10 A approx. The instrument allows to perform the test with 200mA and 25A test current (for resistance between terminals $<0.1\Omega$) or 10A (for resistance between terminals $<0.5\Omega$) with automatic recognition.

1. Press the **FUNC** key and select the **RPE-2WIRE** function. The following screen is shown on the display

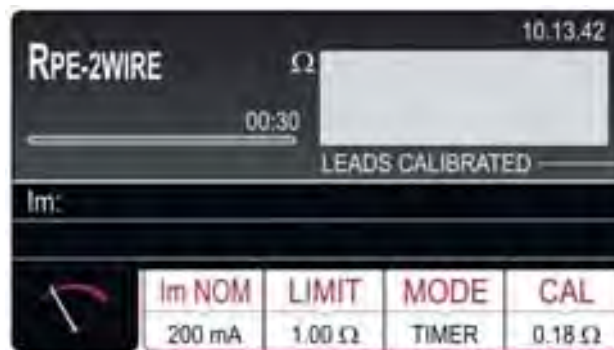

Fig. 25 : RPE-2WIRE initial screen

2. Select the test parameters on the instrument (see Table 1) and carry out the desired setup

Parameter	Description	Value
Im NOM	Nominal test current	200mA or 25A AC ($R < 0.1\Omega$)
		200mA or 10A AC ($R < 0.5\Omega$)
LIMIT	Reference limit threshold	STANDARD
		0.01 Ω ÷ 200.0 Ω (200mA)
		0.01 Ω ÷ 20.0 Ω (25A)
60204 SET L	Test with 25A current (see § 6.1.2)	60204 SET L (25A)
		60204 SET Z (25A)
60204 SET Z		Length: 0.1m ÷ 999.9m
		Section: 1, 1.5, 2.5, 4, 6, 10, 16, 25, 35, 50, 70, 95, 120, 150, 185, 240, 300, 400, 500, 630 mm ²
		Material: Cu (Copper) or Al (Aluminum)
		ZLine: 0.001 Ω ÷ 2.000 Ω
MODE	Measurement mode	MCB protection: B, C, D, K
		Fuse protection: gG, aM
CAL	Test leads calibration	Nominal current protection (see §)
		Manual Timer (2s ÷ 60min)
		up to 5.00 Ω

Table 1 : Setup parameters of RPE-2WIRE function

6.1.1. Test leads calibration

In order to avoid that the test leads do not influence the test results, the resistance of the leads must be calibrated (zeroed) before take measurement.



CAUTION

- The calibration must be done separately for each test current (200mA & 25A)
- The calibration must be repeated when test leads are changed (replaced, shortened or extended)
- Max resistance that can be calibrated is 5Ω
- Existing calibration can be annulled if test leads are opened when calibration is carried out
- **Calibration is not needed in RPE-4WIRE function**

3. Press the **CAL** touch-screen key (8), the message “SHORTCIRCUIT TEST LEADS AND PRESS START TO CALIBRATE” will appear
4. Connect test leads according to the figure below, make sure two crocodiles are connected as close as possible to each other to a piece of unisolated wire (see Fig. 26)



Fig. 26 : Test leads calibration

5. Press the **START** button. The measurement will be done and value without calibration will be displayed for a moment, then the value will be set to zero (0.00). Test leads are thus calibrated, measurements can follow
6. The following specific information may be shown on the display during calibration

Message	Description
SHORTCIRCUIT TEST LEADS AND PRESS START TO CALIBRATE	Calibration has been started (CAL touch-screen key has been pressed). <i>Shortcircuit test leads and press the START button!</i>
OPEN TEST LEADS, CALIBRATION ANNULED	Test leads are opened after pressing the START button. <i>Press YES key ... existing calibration will be annulled! Press NO key ... existing calibration will stay untouched!</i>
RPE > 5Ω CALIBRATION FAILED	Connected resistance is higher than 5Ω and lower than measurement range, calibration can not be carried out. Existing calibration will stay untouched. <i>Reduce external resistance and repeat the calibration!</i>

6.1.2. Set limit value for 25A test current measurement

With test current selection **25A** the instrument allows to perform the continuity test by calculating the reference limit as a function of the length (known in advance) of the conductor or as a function of the impedance of the line power source in accordance with the requirements of the IEC/EN60204-1 guideline.

EN60204 SET L mode

The limit value is calculated based on the length, section and material of the conductor under test. The parameters can be selected/adjusted within the values shown in Table 1

EN60204 SET Z mode

The limit value is calculated based on the input line impedance (Z_{LINE}), the type of protection of the line, the rated current of the protection and the section of the conductor under test. The values of the selectable parameters are the followed:

- Line impedance range: **0.001Ω ÷ 2.000Ω** in steps of 0.001Ω
 - Type of MCB protection: **B, C, D, K** curves
 - Nominal current of MCB protection: 6, 10, 13, 16, 20, 25, 32, 40, 50, 63A (B curve), 0.5, 1, 1.6, 2, 4, 6, 10, 13, 16, 20, 25, 32, 40, 50, 63A (C curve), 0.5, 1, 1.6, 2, 4, 6, 10, 13, 16, 20, 25, 32A (D, K curves)
 - Type of Fuse protection: **gG, aM**
 - Nominal current of Fuse protection **gG**: 2, 4, 6, 10, 13, 16, 20, 25, 32, 35, 40, 50, 63, 80, 100, 125, 160, 200, 224, 250, 315, 355, 400, 500, 630A
 - Nominal current of Fuse protection **aM**: 6, 10, 16, 20, 25, 32, 35, 40, 50, 63, 80, 100, 160, 224, 250, 315, 355, 400, 500, 630A
 - Conductor section: 1, 2.5, 4, 6, 10, 16, 25, 35, 50, 70, 95, 120, 150, 185, 240, 300, 400, 500, 630mm²
7. Check selected mode (MANUAL or TIMER) and modify it if needed by pressing the **MODE** key. In MANUAL mode the measurement will start after pressing the **START/STOP** key and will stop after pressing the **START/STOP** key again. In TIMER mode the measurement will start after pressing the **START/STOP** key and will stop after elapsing set measurement time or after pressing the **START/STOP** button again
 8. Select measurement screen by pressing the  touch-screen key and check all settings again
 9. Connect the test leads according to the below Fig. 27

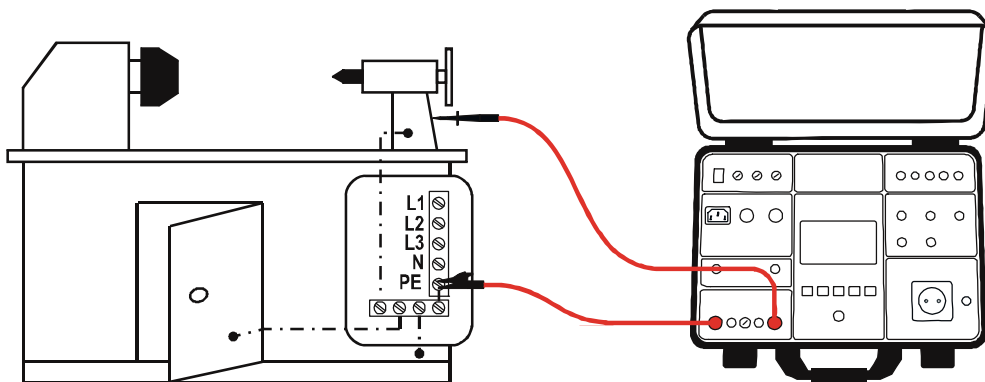

Fig. 27 : Connection of test leads in RPE-2WIRE function

CAUTION



Before connecting test leads to UUT obligatory assure there is no external voltage higher than 10 V between the test points where test leads will be connected to, otherwise fuse F4 may blow

10. Press the **START/STOP** key to perform the measurement. The test result is shown on the display (see Fig. 28)

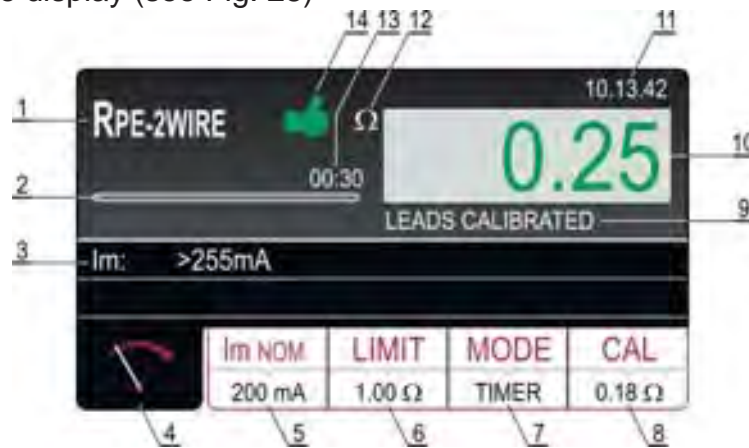







Fig. 28 : Visualization of RPE-2WIRE test result

Meaning of symbols on the display

Item	Description
1	Selected function
2	Progress bar, it follows measurement time during the measurement (in TIMER mode only)
3	Sub-result – real test current applied
4	Measurement screen touch-screen key
5	Im NOM touch-screen key to select nominal test current (200 mA or 25 A). Currently selected value is displayed on the bottom of the key
6	LIMIT touch-screen key to select limit value (200 mA measurement) or limit mode (25 A measurement). Currently selected value or CALC is displayed on the bottom of the key. CALC message means the value is calculated
7	MODE touch-screen key to select operation mode (MANUAL or TIMER). Currently selected mode is displayed on the bottom of the key. TIMER mode is available in 200mA measurement and in 25A measurement if STANDARD limit mode is selected
8	CAL touch-screen key to carry out calibration of test leads. Currently calibrated value is displayed on the bottom of the key. In case of no calibration, the value 0.00Ω is displayed in red color
9	Test lead calibration status (LEADS CALIBATED or LEADS NOT CALIBRATED)
10	Measurement value (in green colour - result OK , in red colour - result NON OK)

Item	Description
11	Real time clock (hh.mm.ss).
12	Unit of measurement result (Ω)
13	Set measurement time (in TIMER mode only)
14	Measurement result status (symbol  in green color - result OK, symbol  in red color - result not OK or symbol  in yellow color – result OK, but measurement current too low)

11. Test result will currently be displayed in green (result lower than or equal to set limit value) or in red colour (result higher than set limit value). Final result will be equipped with green  symbol and with beep-beep sound (result OK) or with red  symbol and with longer beep sound (result not OK) or with yellow  symbol and with beep-beep sound (result OK, but measurement current was too low)
12. Save the test result by pressing the **SAVE** key (see § 7.1)







CAUTION



- Max external voltage between two RPE or between two SENSE test terminals is 10 VAC, no DC external voltage is allowed! In case of higher external voltage fuse F4 (T20A/500V, 6.3x32 mm) may blow
- Measurement time in MANUAL mode is limited to 5min
- The measurement time can be set from 2s÷60min independently by the selected test current except for 25A measurement in which the measurement time is from 00:02 to 05:00 (2s to 5min)

6.1.3. Anomalous situations

The following specific information can be shown on the display during measurement

Information displayed	Description
 CHECK CALIBRATION	Measurement result is negative probably because of shorter test leads than calibrated (negative value is higher than 5 digits). <i>Calibrate test leads again!</i>
 EXTERNAL VOLTAGE	<ul style="list-style-type: none"> • External voltage higher than 3 V is applied between two RPE or between two SENSE test terminals (measurement is not running) or higher than 10 V (measurement is running). • External voltage higher than 5 ÷30 V is applied between any RPE or SENSE test terminal and GND. <i>Remove external voltage!</i>
 LIMIT OUT OF RANGE	Calculated limit value is < 1 (EN60204 SET Z limit mode).
 FUSE F4!	Fuse F4 is blown.
 ERROR 1!	Internal fuse may be blown! <i>The fuse is not customer replaceable, send the tester into a service department.</i>
 MEAS. TIME > 5MIN CHECK TIMER	The Timer is set to a value higher then 5 minutes with 25A test selected. <i>The test with 25A current allows to set the timer up to maximum 5 minutes</i>

6.2. CONTINUITY OF PE CONDUCTOR – 4-WIRE METHOD (RPE-4WIRE)

The continuity measurement performed with the 4-wire method is only available with a test current of 25A and, due to the nature of the Kelvin method used, **it does not require any calibration of the test lead resistance**. This means that it is possible to extend (in pairs) the test cables and perform the test without altering the measurement result. For the extension of each cable it is recommended to use the optional **1066-IECN** (Black) and **1066-IECR** (Red)

1. Press the **FUNC** key and select the **RPE-4WIRE** function. The following screen is shown on the display

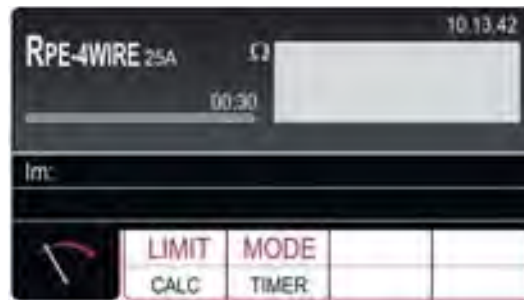

Fig. 29 : RPE-4WIRE initial screen

2. Select the test parameters on the instrument (see Table 2) and carry out the desired setup

Parameter	Description	Value
LIMIT	Reference limit threshold	STANDARD 0.01Ω ÷ 20.0Ω
		60204 SET L 60204 SET Z
60204 SET L	Test with 25A current (see §)	Length: 0.1m ÷ 999.9m
60204 SET Z		Section: 1, 1.5, 2.5, 4, 6, 10, 16, 25, 35, 50, 70, 95, 120, 150, 185, 240, 300, 400, 500, 630 mm ²
		Material: Cu (Copper) or Al (Aluminum)
		ZLine: 0.001Ω ÷ 2.000Ω
MODE	Measurement mode	MCB protection: B, C, D, K
		Fuse protection: gG, aM
TIMER	Measurement time	Nominal current protection (see §)
		Manual / Timer
		00:02 ÷ 05:00 (2s ÷ 5min)

Table 2 : Setup parameters of RPE-4WIRE function

6.2.1. Set limit value

The instrument allows to perform the continuity test by calculating the reference limit as a function of the length (known in advance) of the conductor or as a function of the impedance of the line power source in accordance with the requirements of the IEC/EN60204-1 guideline.

EN60204 SET L mode

The limit value is calculated based on the length, section and material of the conductor under test. The parameters can be selected/adjusted within the values shown in Table 1

EN60204 SET Z mode

The limit value is calculated based on the input line impedance (ZLINE), the type of protection of the line, the rated current of the protection and the section of the conductor under test. The values of the selectable parameters are the followed:

- Line impedance range: **0.001Ω ÷ 2.000Ω** in steps of 0.001Ω
 - Type of MCB protection: **B, C, D, K** curves
 - Nominal current of MCB protection: 6, 10, 13, 16, 20, 25, 32, 40, 50, 63A (B curve), 0.5, 1, 1.6, 2, 4, 6, 10, 13, 16, 20, 25, 32, 40, 50, 63A (C curve), 0.5, 1, 1.6, 2, 4, 6, 10, 13, 16, 20, 25, 32A (D, K curves)
 - Type of Fuse protection: **gG, aM**
 - Nominal current of Fuse protection **gG**: 2, 4, 6, 10, 13, 16, 20, 25, 32, 35, 40, 50, 63, 80, 100, 125, 160, 200, 224, 250, 315, 355, 400, 500, 630A
 - Nominal current of Fuse protection **aM**: 6, 10, 16, 20, 25, 32, 35, 40, 50, 63, 80, 100, 160, 224, 250, 315, 355, 400, 500, 630A
 - Conductor section: 1, 2.5, 4, 6, 10, 16, 25, 35, 50, 70, 95, 120, 150, 185, 240, 300, 400, 500, 630mm²
3. Check selected mode (MANUAL or TIMER) and modify it if needed by pressing the **MODE** key. In MANUAL mode the measurement will start after pressing the **START/STOP** key and will stop after pressing the **START/STOP** key again. In TIMER mode the measurement will start after pressing the **START/STOP** key and will stop after elapsing set measurement time or after pressing the **START/STOP** button again
 4. Select measurement screen by pressing the  touch-screen key and check all settings again
 5. Connect the test leads according to the below Fig. 30

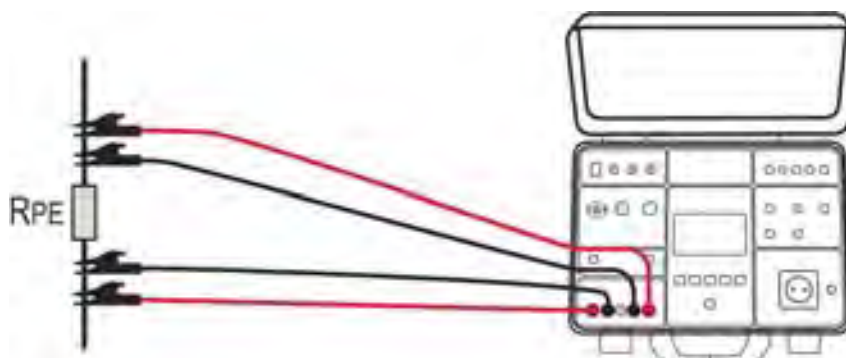

Fig. 30 : Connection of test leads in RPE-4WIRE function



CAUTION

Before connecting test leads to UUT obligatory assure there is no external voltage higher than 10V between the test points where test leads will be connected to, otherwise fuse F4 may blow

6. Press the **START/STOP** key to perform the measurement. The test result is shown on the display (see Fig. 31)

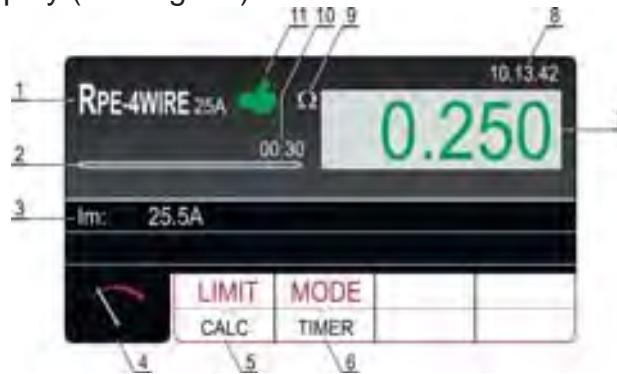

Fig. 31 : Visualization of RPE-4WIRE test result

Meaning of symbols on the display

Item	Description
1	Selected function
2	Progress bar, it follows measurement time during the measurement (in TIMER mode only)
3	Sub-result – real test current applied
4	Measurement screen touch-screen key
5	LIMIT touch-screen key to select limit mode (STANDARD, 60204 SET Z or 60204 SET L). Currently selected value (STANDARD mode) or CALC (60204 SET Z or 60204 SET L mode) is displayed on the bottom of the key. CALC message means the value is calculated
6	MODE touch-screen key to select operation mode (MANUAL or TIMER). Currently selected mode is displayed on the bottom of the key. TIMER mode is available only if STANDARD limit mode is selected
7	Measurement value (in green color - result OK , in red color - result NON OK)
8	Real time clock (hh.mm.ss).
9	Unit of measurement result (Ω)
10	Set measurement time (in TIMER mode only)
11	Measurement result status (symbol in green color - result OK, symbol in red color – result not OK)

7. Test result will currently be displayed in green (result lower than or equal to set limit value) or in red colour (result higher than set limit value). Final result will be equipped with green symbol and with beep-beep sound (result OK) or with red symbol and with longer beep sound (result not OK) or with yellow symbol and with beep-beep sound (result OK, but measurement current was too low)

8. Save the test result by pressing the **SAVE** key (see § 7.1)





CAUTION



- **Max external voltage between two RPE or between two SENSE test terminals is 10 VAC, no DC external voltage is allowed! In case of higher external voltage fuse F4 (T20A/500V, 6.3x32 mm) may blow**
- **If SENSE test leads are not connected, then measurement result will include also the resistance of current test leads**
- **Measurement time in MANUAL mode is limited to 5min**

6.2.2. Anomalous situations

The following specific information can be shown on the display during measurement

Information displayed	Description
 EXTERNAL VOLTAGE	<ul style="list-style-type: none"> • External voltage higher than 3 V AC is applied between two RPE or between two SENSE test terminals (measurement is not running) or higher than 10 V AC (measurement is running). • External voltage higher than 5 ÷30 V is applied between any RPE or SENSE test terminal and GND. <p><i>Remove external voltage!</i></p>
 FUSE F4!	Fuse F4 is blown.
 ERROR1!	Internal fuse may be blown! <i>The fuse is not customer replaceable, send the tester into a service department.</i>
 MEAS. TIME > 5MIN CHECK TIMER	The Timer is set to a value higher then 5 minutes with 25A test selected. <i>The test with 25A current allows to set the timer up to maximum 5 minutes</i>

6.3. INSULATION RESISTANCE (MΩ)

In accordance with the requirements of the IEC/EN60204-1 guideline, the insulation resistance between the machine power circuits and the earth reference must be checked by applying a test voltage of **500VDC**. The minimum reference limit value is **1MΩ**. Make sure that all the switches of the object under examination are closed in order to check all its components. For the measurement, all active conductors (L1, L2, L3 and N) must be short-circuited. **Disconnect or dissect all machine control parts/logics that could be damaged by the test voltage**

1. Press the **FUNC** key and select the **MΩ** function. The following screen is shown on the display



Fig. 32 : MΩ initial screen

2. Select the test parameters on the instrument (see Table 3) and carry out the desired setup

Parameter	Description	Value
Um NOM	Nominal test voltage	100, 250, 500, 1000VDC
MODE	Measurement mode	Manual, Timer, Auto
TIMER	Measurement time	00:01 ÷ 60:00 (1s ÷ 60min)
LIMIT	Minimum reference limit threshold	0.01MΩ ÷ 100.0MΩ

Table 3 : Setup parameters of RPE-4WIRE function

3. Check selected mode and modify it if needed by pressing the **MODE** touch-screen key first. MANUAL, TIMER or AUTO mode can be selected. In MANUAL mode, the measurement is activated/terminated by pressing the **START/STOP** key. In TIMER mode, the measurement is activated by pressing the **START/STOP** key and is finished or upon reaching a stable result at the end of the set measurement time or by pressing the **START/STOP** key again. In AUTO mode the measurement is finished when a stable result is reached
4. Check selected limit value and modify it if needed by pressing the **LIMIT** touch-screen key first. Four independent preset limit values are available for quicker operations. Select the one closest to wished value and modify it by using the **+** and **-** touch screen keys if needed
5. Select measurement screen by pressing the touch-screen key and check all settings again
6. Connect the test leads according to the below Fig. 33

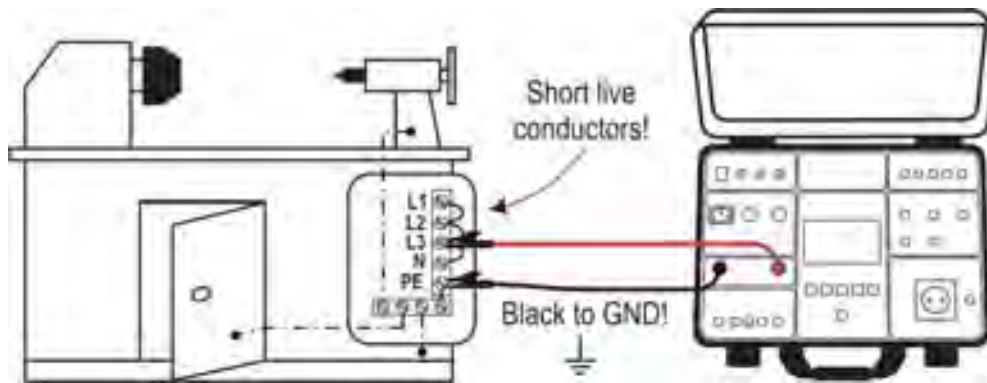

Fig. 33 : Connection of test leads in MΩ function

7. Press the **START/STOP** key to perform the measurement. The test result is shown on the display (see Fig. 34)

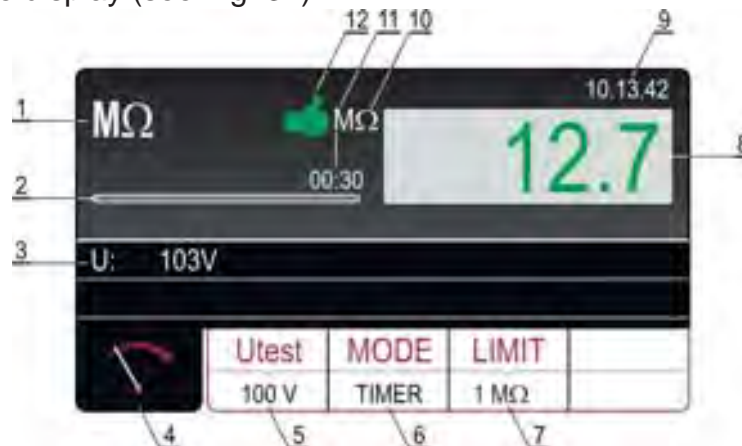



Fig. 34 : Visualization of MΩ test result

Meaning of symbols on the display

Item	Description
1	Selected function
2	Progress bar, it follows measurement time during the measurement (in TIMER mode only)
3	Test voltage applied during the measurement
4	Measurement screen touch-screen key
5	Utest touch-screen key to select nominal test voltage (100, 250, 500 or 1000VDC). Currently selected value is displayed on the bottom of the key
6	MODE touch-screen key to select operation mode (MANUAL, TIMER or AUTO). Currently selected mode is displayed on the bottom of the key
7	LIMIT touch-screen key to select limit insulation resistance. Currently selected value is displayed on the bottom of the key
8	Measurement value (in green color - result OK , in red color - result NON OK)
9	Real time clock (hh.mm.ss).
10	Unit of measurement result (MΩ)
11	Set measurement time (in TIMER mode only)
12	Measurement result status (symbol in green color - result OK, symbol in red color – result not OK)

8. Test result will currently be displayed in green colour (result higher than or equal to set limit value) or in red colour (result lower than set limit value). Final result will be equipped with green  symbol and with beep-beep sound (result OK) or with red  symbol and with longer beep sound (result not OK)
9. Save the test result by pressing the **SAVE** key (see § 7.1)

6.3.1. Anomalous situations

The following specific information can be shown on the display during measurement

Information displayed	Description
 EXTERNAL VOLTAGE	<ul style="list-style-type: none"> • External voltage higher than 10 V AC approx. is applied between positive and negative test terminals (measurement is not running) or higher than 50 V AC approx. (measurement is running). • Negative external voltage higher than 10 V DC approx. is applied between positive and negative test terminals (measurement is running). <p><i>Remove external voltage!</i></p>
DISCHARGING!	External capacitor (or internal) that was charged during the measurement is discharging. <i>Wait until the message disappears! Do not disconnect test leads until the message is present!</i>

6.4. DIELECTRIC TEST (DIELECTRIC)

In accordance with the requirements of the IEC/EN60204-1 guideline, the power circuits of electrical machines must withstand a voltage test between active short-circuit conductors and the earthing system for at least **1s**. The test is performed at twice the nominal power supply (or 1000VAC choosing the larger of the two values) 50Hz. **Disconnect or dissect all machine control parts / logics that could be damaged by the test voltage.**

CAUTION

The instrument supplies high voltage of a dangerous power. According to **EN50191** guideline (see § 5.5.2) the following precautionary measures must be taken prior to a test

- Block access to danger area
- Put up warning signs (Attention! High voltage, danger to life)
- Install warning lamps (red, green) to be easily visible (consider the **FT3R-GLP** optional accessory)
- Install EMERGENCY-OFF switch into the mains installation outside the dangerous area (consider the **FT3SFTSW** optional accessory)
- Electrical trained personnel may only do the tests under supervision of specialist staff and have to be trained regularly
- **Use safety probes with protection against contact or with two-hand operation only. Always hold only one probe in one hand**
- Connecting one test terminal to the UUT and working with one probe or holding both probes in one hand is prohibited
- It is prohibited to touch the unit under test during the test. If need be, additional measures must be taken (e.g. cover made of insulating mats) to protect the person performing the test against inadvertent contact with the test object
- Ensure that all switches on the UUT are closed in order to test all it's components. For the purpose of measurement all active conductors (L1, L2, L3 and N) must be short-circuited



1. Press the **FUNC** key and select the **DIELECT** function. The following screen is shown on the display

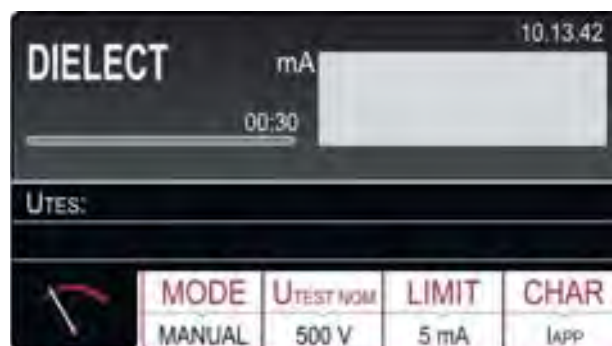

Fig. 35 : DIELECT initial screen

2. Select the test parameters on the instrument (see Table 4) and carry out the desired setup

Parameter	Description	Value
Utest NOM	Nominal test voltage	250V ÷ 5100VAC
MODE	Measurement mode	Manual, Burn, Pulse Ramp 75%, Ramp 50%
TIMER	Measurement mode (Ramp only)	00:01 ÷ 10:00 (1s ÷ 10min)
LIMIT	Discharge current limit threshold	1mA ÷ 110mA
CHAR	Typology of discharge current	IAPP or IREAL (see §)

Table 4 : Setup parameters of DIELECT function

6.4.1. Measurement modes

The instrument allows the selection of the following operating modes:

- **Manual** mode → The test voltage is maintained constantly until the **START/STOP** key is pressed (see Fig. 36). The measured discharge current is compared with the set limit value and the result is stored in memory
- **Burn** mode → The test voltage is maintained constantly until the **START/STOP** key is pressed (see Fig. 36) but the result is NOT compared with any limit and is NOT stored in the memory (functional test)

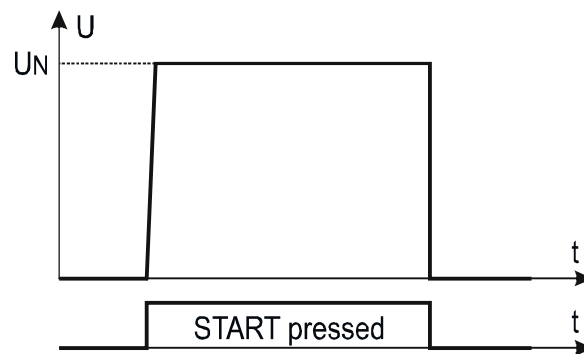

Fig. 36 : DIELECTRIC test in Manual or Burn mode

- **75% Ramp** mode (**single ramp**) → When the **START/STOP** key is pressed, the test voltage rises up to 75% of the nominal voltage then it takes 5s to reach the nominal value. It is subsequently maintained for a time defined by a programmable timer (see Fig. 37)

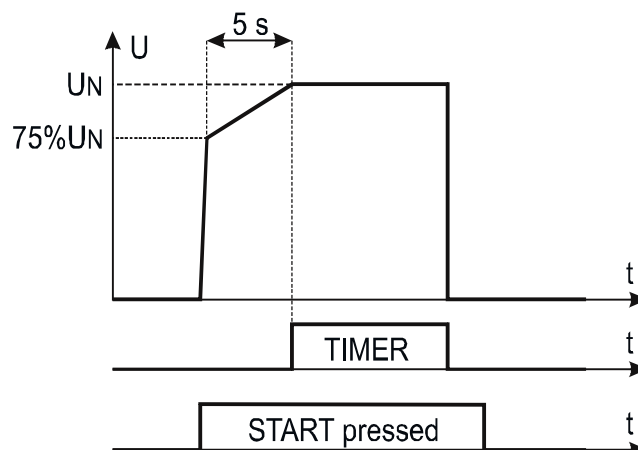

Fig. 37 : DIELECTRIC test in 75% Ramp mode

- **50% Ramp mode (double ramp)** → When the **START/STOP** key is pressed, the test voltage rises up to 50% of the nominal voltage then it takes 1s to reach 75% of the nominal value then it uses another 5s to reach the nominal value. It is subsequently maintained for a time defined by a programmable timer (see Fig. 38)

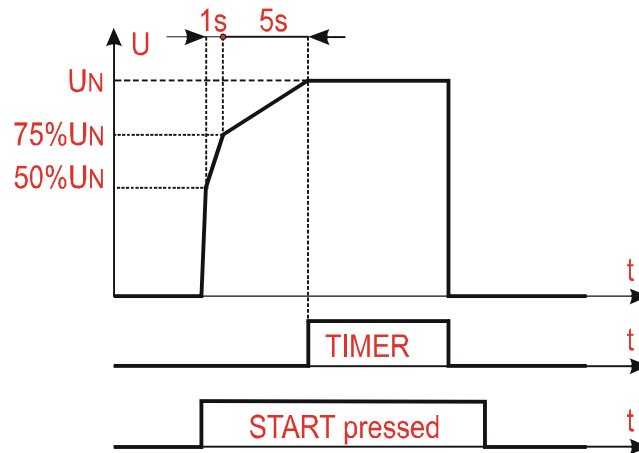



Fig. 38 : DIELECTRIC test in 50% Ramp mode

- **Pulse mode** → the effective test has a duration of 3 measurement cycles (60ms @ 50Hz, 50ms @ 60Hz) according to IEC/EN61439-1 3rd edition

6.4.2. Typology of discharge current

The instrument is able to measure the dielectric leakage current in the following two modes:

- **IAPP** → the instrument measures the total RMS value of the dielectric leakage current (including capacitive components)
 - **IREAL** → the instrument only measures the "real" part of the current, that is the current in phase with the voltage and therefore associable with a loss of the Resistive type (recommended in most cases). This last mode serves to "ignore" the capacitive current component typically introduced by filters for electromagnetic compatibility (whose current is obviously not associated with any type of loss / break)
3. Check selected mode and correct it if needed by pressing the **MODE** touch-screen key first. MANUAL, RAMP, PULSE or BURN mode can be selected
 4. Check selected test voltage (250 up to 5100V) and correct it if needed by pressing the **UTES NOM** touch-screen key first
 5. Check selected limit current and correct it if needed by pressing the **LIMIT** touch-screen key first. Four independent preset limit currents are available for quicker operations. Select the one closest to wished value and modify it by using the **+** and **-** touch screen keys if needed
 6. Check selected character of displayed current (IAPP or IREAL) and correct it if needed by pressing the **CHAR** touch-screen key first
 7. Select measurement screen by pressing the  touch-screen key and check all settings again
 8. Insert the measurement terminals between the **COM** input and the input corresponding to the programmed test voltage and connect the instrument as shown in Fig. 39. Always connect the **COM** terminal to the GND ground if the measured OUT output is earthed, otherwise any capacitive leakage currents could be discharged to the ground and disturb the measurement

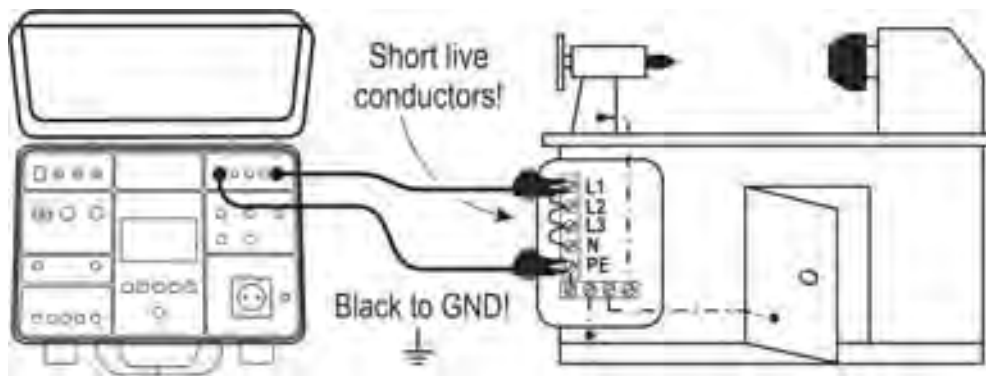

Fig. 39 : Connection of test leads

9. Press the **START/STOP** key to perform the measurement. The test result is shown on the display (see Fig. 40)

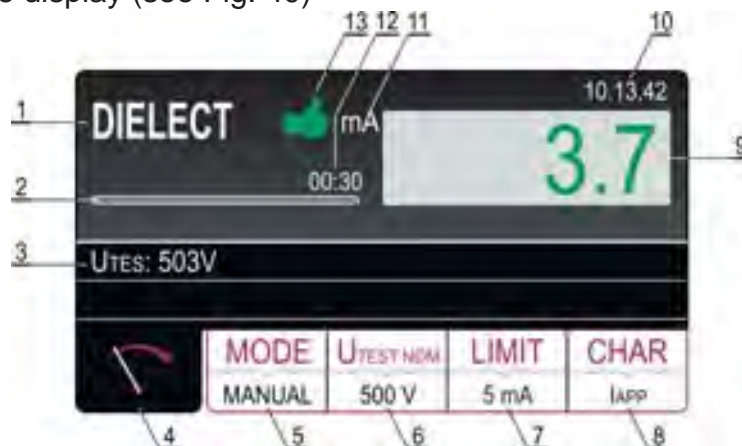





Fig. 40 : Visualization of DIELECT test result

Meaning of symbols on the display

Item	Description
1	Selected function
2	Progress bar, it follows test time during the measurement (in RAMP mode only)
3	Test voltage applied during the measurement
4	Measurement screen touch-screen key
5	MODE touch-screen key to select operation mode (MANUAL, BURN,PULSE, RAMP 75% or RAMP 50%). Currently selected mode is displayed on the bottom of the key
6	U_{TEST NOM} touch-screen key to select nominal test voltage (250 up to 5100 V AC). Currently selected value is displayed on the bottom of the key
7	LIMIT touch-screen key. Currently selected limit leakage current (trip out current) is displayed on the bottom of the key
8	CHAR (character) touch-screen key to select the character of displayed leakage current (IAPP or IREAL). Currently selected character is displayed on the bottom of the key

Item	Description
9	Leakage current in green colour if the result is lower than or equal to set limit value. If break-through occurred during the test then limit value will be displayed in red colour
10	Real time clock (hh.mm.ss).
11	Unit of measurement result (mA)
12	Set measurement time (in RAMP mode only)
13	Measurement result status (symbol  in green colour - result lower than or equal to set limit value, symbol  in red colour - break through occurred during the test or result higher than set limit value)

10. A warning with explanation of how to connect test leads with regard to selected test voltage will be displayed. Check the connection then confirm it by pressing the **YES** touch-screen key, the message "READY" will appear and will stay present for 10 seconds. **START/STOP** button is active while "READY" message is present. Press and keep pressing the **START/STOP** button, test voltage will be applied to test terminals. The test will be stopped after releasing the **START/STOP** button (MANUAL or BURN mode) or after elapsing set test time (RAMP mode). In PULSE mode, press and keep the **START/STOP** button for **at least 5s** until the result is shown on the display
11. Test result will currently be displayed in green color if it is lower than or equal to set limit value. Final result will be equipped with green  symbol and with beep-beep sound (result OK). If break through occurred during the test then the test will be stopped and limit test current will be displayed in red color equipped with red  symbol and with longer beep sound
12. Save the test result by pressing the **SAVE** key (see § 7.1)

6.4.3. Safety devices

SAFETY INPUT

In order to reach higher level of safety, the SAFETY INPUT connector (optional accessory **FT3SFTSW**) is recommended. Safety switch of a mechanical barrier can be connected there in order to disable DIELECTRIC function in case the safety switch is opened. For this purpose select SAFETY INPUT enabled mode in the menu as follows:

MENU hard key → **SETUP** touch-screen key → **EN50191** (see § 5.5.2) touch-screen key → **ENABLED** touch-screen key

WARNING LAMP

According to EN50191 the highest level of safety must be undertaken when working with high voltages like used in DIELECTRIC test. For this purpose the instrument offers an output to drive the high voltage warning lamp (optional accessory **FT3R-GLP**). Use only the lamps supplied by original supplier.

CAUTION



- **Always connect COM terminal to GND if measured UUT is grounded, otherwise possible capacitive leakage current may flow to ground which may disturb the measurement**
- **Measurement time in MANUAL mode is limited to 60 min**

6.4.4. Anomalous situations

The following specific information can be shown on the display during measurement

Information displayed	Description
 ERROR1!	Internal fuse may be blown! <i>The fuse is not customer replaceable, send the tester into a service department.</i>

6.5. TEST ON RCD (RCD)

The instrument allows measurement of time and trip out current (Ramp) on RCD's protection devices type A, AC and B, General, Selective and Delayed according to the IEC/EN61008 and IEC/EN61009 reference guidelines.

1. Press the **FUNC** key and select the **RCD** function. The following screen is shown on the display

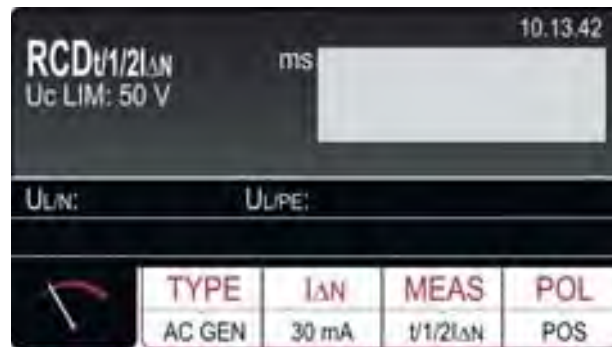

Fig. 41 : RCD initial screen

2. Select the test parameters on the instrument (see Table 5) and carry out the desired setup

Parameter	Description	Value
TYPE	RCD typology	AC, A, B General, Selective, Delayed
I Δ N	Nominal trip out current of RCD	10,30,100,300,500,650,1000mA
MEAS	Measurement modes (trip out time and current)	t/1/2I Δ N, t/I Δ N, t/2I Δ N, t/5I Δ N, I Δ or AUTO
POL	Test current polarity	Positive (0°), Negative (180°)
T DEL	Delayed time (for delayed RCD)	0ms ÷ 700ms

Table 5 : Setup parameters of RCD function

3. Check selected RCD type (AC, A or B) and selected characteristic (GENERAL, SELECTIVE or DELAYED) and modify it if needed by pressing the **TYPE** touch-screen key first. **If DELAYED characteristic is selected, the screen will turn to delay time adjustment mode automatically**
4. Select nominal differential current by pressing the **I Δ N** touch-screen key first
5. Select wished measurement by pressing the **MEAS** touch-screen key first (t/1/2I Δ N, t/I Δ N, t/2I Δ N, t/5I Δ N, I Δ or AUTO)
6. Check selected polarity and modify it if needed by pressing the **POL** (8) touch-screen key first
7. Select measurement screen by pressing the touch-screen key and check all settings again
8. Connect the test leads or te schuko cable as shown in the followed Fig. 42 or Fig. 43

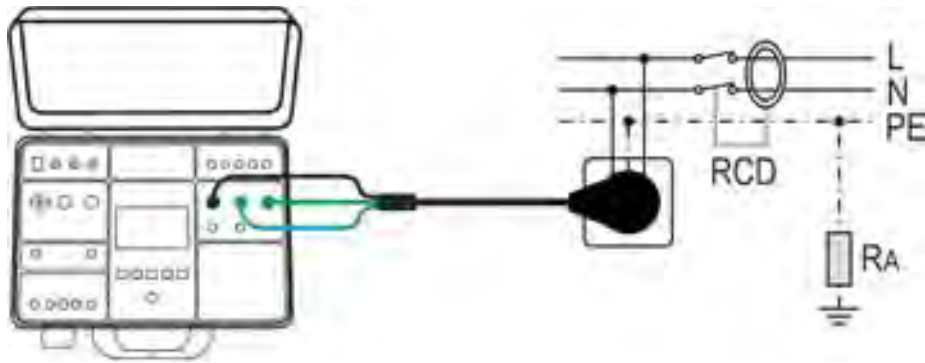

Fig. 42 : Connection of schuko test cable

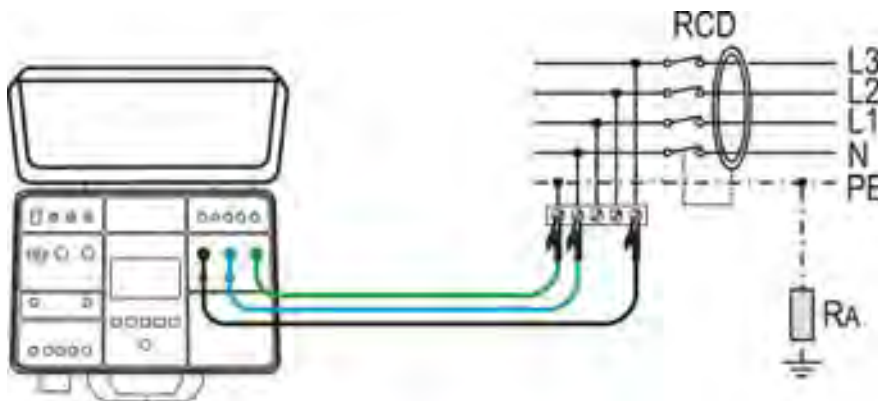

Fig. 43 : Connection of test leads

9. READY message will appear as soon as the tester is properly connected to the installation and mains voltage is present, see the "Input conditions" above
10. Press the **START/STOP** key to perform the measurement. The test result is shown on the display (see Fig. 44)

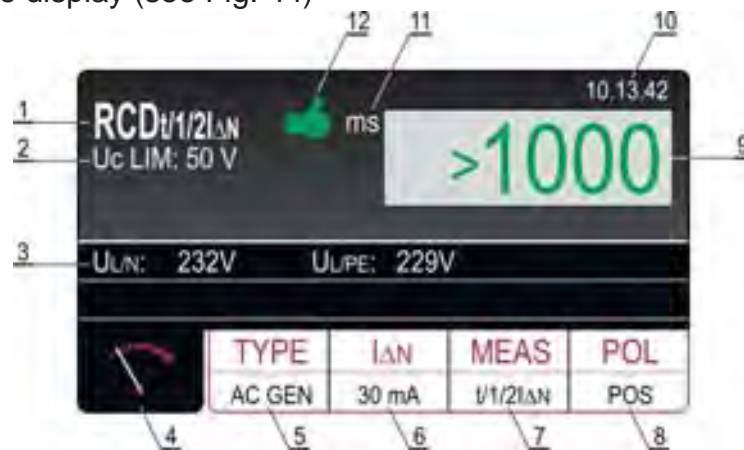





Fig. 44 : Visualization of RCD test result

Meaning of symbols on the display

Item	Description
1	Selected function
2	Selected limit contact voltage (25 or 50 V). It can be selected in MENU → SETUP → CONTACT VOL. menu
3	Sub-results - mains voltages $U_{L/N}$ and $U_{L/PE}$ at which the test was carried out.

Item	Description
4	Measurement screen touch-screen key
5	TYPE touch-screen key to select the type of RCD (AC, A or B) and characteristic (GENERAL, SELECTIVE or DELAYED). Currently selected type and characteristic are displayed on the bottom of the key
6	IΔN touch-screen key to select nominal differential current of the RCD (10, 30, 100, 300, 500, 650 or 1000mA). Currently selected value is displayed on the bottom of the key
7	MEAS touch-screen key to select the measurement (t/1/2I Δ N, t/I Δ N, t/2I Δ N, t/5I Δ N, I Δ or AUTO). Currently selected measurement is displayed on the bottom of the key
8	POL touch-screen key to select test current polarity (POS - positive or NEG - negative)
9	Test result (in green color - result OK, in red color - result not OK)
10	Real time clock (hh.mm.ss)
11	Unit of the test result (ms)
12	Measurement result status (symbol  in green color - result OK, symbol  in red color - result not OK)

11. Test result will be displayed in green color equipped with green  symbol and with acoustic sound if it is within limit range (see the Table 6) of allowed trip out times below. If the result is out of limit range, then it will be displayed in red colour equipped with red  symbol and with longer acoustic sound

Type RCD / I Δ N	I Δ N/2 [ms]	I Δ N [ms]	2I Δ N [ms]	5I Δ N [ms]
General	>1000	≤300	≤150	≤40
Selective	>1000	Tmin = 130	Tmin=60	Tmin=50
		Tmax = 500	Tmax=200	Tmax=150
Delayed	>1000	D ÷ (D + 300)	-	-

D = Delayed time selectable in the range 0 ÷ 700ms

Table 6 : Limit values of RCD trip out time













	Trip out time		Trip out current	AC type, positive polarity
				AC type, negative polarity
				A type, positive polarity
				A type, negative polarity
				B type, positive polarity
				B type, negative polarity

Table 7 : RCD test current waveforms

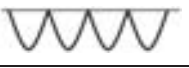
12. Save the test result by pressing the **SAVE** key (see § 7.1)







CAUTION



- When selecting RCD type (TYPE), nominal differential current ($I_{\Delta N}$) or measurement (MEAS) it may happen that wished parameter will not be available (see § 10.5). In this case the level of other parameter or even other two parameters shall be reduced first
- In case both voltages $U_{L/N}$ and $U_{L/PE}$ within required range $100 \div 265V$ are present at L/N/PE test terminals (also displayed) but there is no READY message displayed, check if energizing socket is correctly earthed

6.5.1. Anomalous situations

The following specific information can be shown on the display during measurement

Information displayed	Description
 VOLTAGE OUT OF RANGE	Input voltage $U_{L/N}$ or $U_{L/PE}$ out of required range $100 \div 265 V$ after pressing the START key.
 MEASUREMENT FAILED!	Input voltage failed during the measurement (disconnection of test leads, installation fuse tripped etc.)
 CONTACT VOLTAGE!	Contact voltage higher than set limit value (25 V or 50 V)
 EXTERNAL IMPEDANCE TOO HIGH!	Impedance in L conductor is too high, preset current can not be generated.
 FUSE F3!	Fuse F3 is blown.
 HOT!	Internal circuitry is overheated. <i>Wait to cool it down!</i>

6.6. LOOP IMPEDANCE TEST (LOOP)

In accordance with the regulation of IEC/EN60204-1 guideline, the protection conditions against electric shocks in systems with automatic disconnection of the mains voltage are:

- Measurement or evaluation of fault loop impedance and testing the over-current protection device involved in the fault loop
- Limit values are shown in the Table 10 of IEC/EN60204-1 guideline

1. Press the **FUNC** key and select the **LOOP** function. The following screen is shown on the display

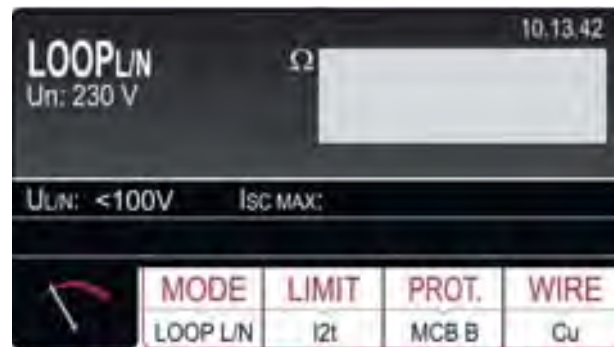

Fig. 45 : LOOP initial screen

2. Select the test parameters on the instrument (see Table 8) and carry out the desired setup

Parameter	Description	Value
MODE	Standard measurement mode	LOOP L/N, LOOP L/L, LOOP L/PE
	Measurement mode with IMP57	IMP57 L/N, IMP57 L/L, IMP57 L/PE
LIMIT	Measurement type for limit value calculation (see §)	STD, kA, I ² t, TRIP CURR., Ut
PROT	Protection type	MCB protection: B, C, D, K
		Fuse protection: gG, aM
		Nominal current protection (see §)
	I _b = max breaking capacity	1, 1.5, 3, 4.5, 6, 10, 15, 16, 20, 25 kA
T _{set} = max trip out time	0.1s, 0.2s, 0.4s, 5s	
WIRE	Conductor type	Cu (Copper), Al (Aluminum)
	Conductor insulation	PVC, Butyl rubber, EPR/XLPE
	Conductor section	1, 1.5, 2.5, 4, 6, 10, 16, 25, 35, 50, 70, 95, 120, 150, 185, 240, 300, 400, 500, 630 mm ²
	Number of conductor in parallel	1 ÷ 99

Table 8 : Setup parameters of LOOP function

6.6.1. Measurement limit value settings

The instrument allows to perform measurement of the Loop impedance and the calculation of the corresponding prospective short-circuit current (Isc). The following 5 modes are available for selecting the presumed ISC LIM limit short-circuit current which define the basis of the final evaluation:

STD mode (Standard)

No verification is performed by the instrument. In this case, no limit is considered, the test result is not evaluated and is always considered neutral (displayed in white)

kA mode (protection breaking capacity verification)

The instrument verifies that the short-circuit current should be lower than the breaking capacity of the BC (Breaking Capacity) protection expressed in kA, that is the breaking capacity of the over-current protection device inserted. The measured **ISC MAX** value must be less than or equal to the breaking capacity **I_b** of the overcurrent protection device inserted, selectable between the values: **1, 1.5, 3, 4.5, 6, 10, 15, 16, 20, 25kA**

I²t mode

The instrument verifies that the protection device reacts before the conductors overheat and are therefore damaged. On the basis of the measured **ISC MAX** values, of the protection device inserted, of the rated current of the protection device (I_n), the instrument calculates the trip time of the protection device (t) (see §). It is possible to select the parameters to be inserted between the following values:

- Type of MCB protection: **B, C, D, K** curves
- Nominal current of MCB protection: 6, 10, 13, 16, 20, 25, 32, 40, 50, 63A (B curve), 0.5, 1, 1.6, 2, 4, 6, 10, 13, 16, 20, 25, 32, 40, 50, 63A (C curve), 0.5, 1, 1.6, 2, 4, 6, 10, 13, 16, 20, 25, 32A (D, K curves)
- Type of Fuse protection: **gG, aM**
- Nominal current of Fuse protection **gG**: 2, 4, 6, 10, 13, 16, 20, 25, 32, 35, 40, 50, 63, 80, 100, 125, 160, 200, 224, 250, 315, 355, 400, 500, 630A
- Nominal current of Fuse protection **aM**: 6, 10, 16, 20, 25, 32, 35, 40, 50, 63, 80, 100, 160, 224, 250, 315, 355, 400, 500, 630A
- Wire material: **Cu** (Copper), **Al** (Aluminum)
- Wire coating: **PVC, Butyl rubber, EPR/XLPE**
- Conductor section: 1, 2.5, 4, 6, 10, 16, 25, 35, 50, 70, 95, 120, 150, 185, 240, 300, 400, 500, 630 mm²
- number of conductors in parallel: 1 ÷ 99

TRIP CURR mode (trip out current)

The instrument verifies that the protection device tripping within the established time at the measured short-circuit current. Based on the measured **ISC MIN** values, the type of protection device inserted and the rated current of the protection device (I_n), the instrument calculates the trip out time which must be less than or equal to the inserted Tset. The parameters to be inserted can be selected from the following values:

- Type of MCB protection: **B, C, D, K** curves
- Nominal current of MCB protection: 6, 10, 13, 16, 20, 25, 32, 40, 50, 63A (B curve), 0.5, 1, 1.6, 2, 4, 6, 10, 13, 16, 20, 25, 32, 40, 50, 63A (C curve), 0.5, 1, 1.6, 2, 4, 6, 10, 13, 16, 20, 25, 32A (D, K curves)
- Type of Fuse protection: **gG, aM**
- Nominal current of Fuse protection **gG**: 2, 4, 6, 10, 13, 16, 20, 25, 32, 35, 40, 50, 63, 80, 100, 125, 160, 200, 224, 250, 315, 355, 400, 500, 630A
- Nominal current of Fuse protection **aM**: 6, 10, 16, 20, 25, 32, 35, 40, 50, 63, 80, 100, 160, 224, 250, 315, 355, 400, 500, 630A
- **Tset** – Maximum trip out time of protection: **0.1s, 0.2s, 0.4s, 5s**

Ut mode

The instrument verifies that the short-circuit current is such that the protection device reacts within the established time. Based on the protection device inserted, the rated current of the protection device (I_n) and the T_{set} , the instrument calculates the required short-circuit current (I_a). The measured **ISC MIN** value must be greater than or equal to the calculated current I_a . The parameters to be inserted can be selected from the following values:

- Type of MCB protection: **B, C, D, K** curves
- Nominal current of MCB protection: 6, 10, 13, 16, 20, 25, 32, 40, 50, 63A (B curve), 0.5, 1, 1.6, 2, 4, 6, 10, 13, 16, 20, 25, 32, 40, 50, 63A (C curve), 0.5, 1, 1.6, 2, 4, 6, 10, 13, 16, 20, 25, 32A (D, K curves)
- Type of Fuse protection: **gG, aM**
- Nominal current of Fuse protection **gG**: 2, 4, 6, 10, 13, 16, 20, 25, 32, 35, 40, 50, 63, 80, 100, 125, 160, 200, 224, 250, 315, 355, 400, 500, 630A
- Nominal current of Fuse protection **aM**: 6, 10, 16, 20, 25, 32, 35, 40, 50, 63, 80, 100, 160, 224, 250, 315, 355, 400, 500, 630A
- **Tset** – Maximum trip out time of protection: **0.1s, 0.2s, 0.4s, 5s**

6.6.2. Prospective short circuit current calculation

	LIMIT mode	TT system Evaluation condition	TN system Evaluation condition
L/L	STD	No evaluation	No evaluation
	kA	ISC L/L MAX 3PH < BC	ISC L/L MAX 3PH < BC
	I^2t	$(ISC\ L/L\ MAX\ 3PH)^2 \times t < (K \times N \times S)^2$	$(ISC\ L/L\ MAX\ 3PH)^2 \times t < (K \times N \times S)^2$
	TRIP CURR.	ISC L/L MIN 2PH → Tmax, Tmax < Tlim	ISC MIN 2PH → Trip time T, T < Tlim
	Ut		
L/N	STD	No evaluation	No evaluation
	kA	ISC L/L MAX 3PH < BC	ISC L/L MAX 3PH < BC
	I^2t	$(ISC\ L/N\ MAX)^2 \times t < (K \times N \times S)^2$	$(ISC\ L/N\ MAX)^2 \times t < (K \times N \times S)^2$
	TRIP CURR.	ISC MIN 2PH → Trip time T, T < Tlim	ISC MIN 2PH → Trip time T, T < Tlim
	Ut		
L/N	STD	No evaluation	No evaluation
	kA	ISC MAX L/N < BC	ISC MAX L/N < BC
	I^2t	$(ISC\ MAX\ L/N)^2 \times T < (K \times N \times S)^2$	$(ISC\ MAX\ L/N)^2 \times T < (K \times N \times S)^2$
	TRIP CURR.	ISC MIN L/N → Trip time T, T < Tlim	ISC MIN L/N → Trip time T, T < Tlim
	Ut		
L/PE	STD	No evaluation	No evaluation
	kA	ISC MAX L/PE < BC	ISC MAX L/PE < BC
	I^2t	$(ISC\ MAX\ L/PE)^2 \times T < (K \times N \times S)^2$	$(ISC\ MAX\ L/PE)^2 \times T < (K \times N \times S)^2$
	TRIP CURR.	ISC MIN L/PE → Trip time T, T < Tlim	ISC MIN L/PE → Trip time T, T < Tlim
	Ut	ISC MIN L/PE > N × In	ISC MIN L/PE > N × In

where:

BC = breaking capacity of the protection

T = Trip out time according to the characteristic and nominal current of used protection device

K = see the below table

Material/Coating	PVC	Natural / Butyl rubber	EPR/XLPE
Cu (Copper)	K = 115	K = 135	K = 143
Al (Aluminum)	K = 76	K = 87	K = 94

N = Number of conductors

S = Cross section of a conductor

For calculation of short-circuit current ISC nominal voltage Un of mains installation is needed, so it must be selected in prior to the measurements. How to select the nominal voltage Un: Press the **MENU** → **SETUP** → **NOMINAL VOL.** touch-screen keys and select the desired value (see § 5.5)

3. Check selected measurement mode (LOOP L/N, LOOP L/L, LOOP L/PE, IMP57 L/N, IMP57 L/L or IMP57 L/PE) and modify it if needed by pressing the **MODE** touch-screen key first

4. In case of measurement with optional accessory **IMP57** it is necessary to use the adapter cable (optional accessory **C2009AD**) for the connection to the USB2 or USB3 ports of the instrument. To carry out the measurement, refer to the user manual of the IMP57 accessory
5. Check selected limit mode (STD, kA, I^2t , TRIP CURR. or U_t) and modify it if needed after pressing the **LIMIT** touch-screen key
6. Check other parameters (they depend on selected limit mode) like type of protection, nominal current, wire material etc. and modify them if needed by pressing appropriate parameter touch-screen key first
7. Select measurement screen by pressing the  touch-screen key and check all settings again
8. Connect the test leads or the cable with schuko plug according to one of the below figures

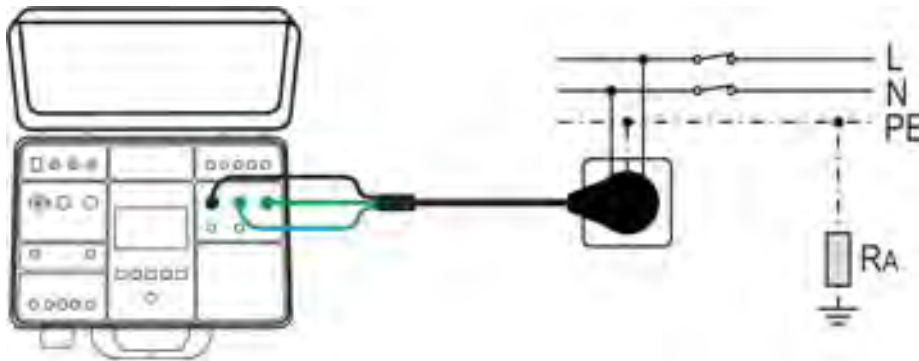

Fig. 46 : Connection with schuko cable for LOOPL/N or LOOPL/PE test

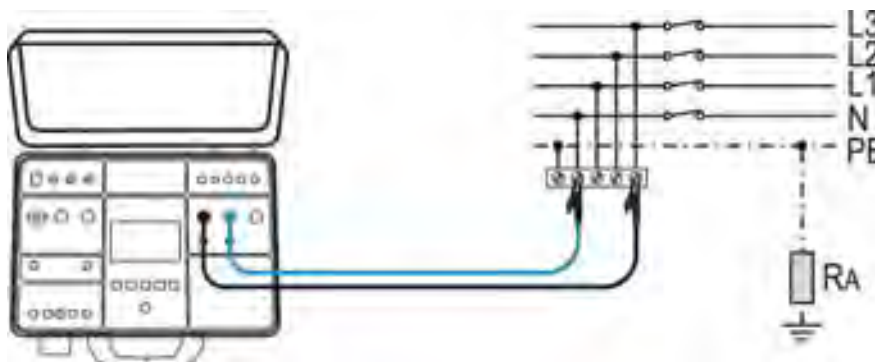

Fig. 47 : Connection with test leads for LOOPL/N test

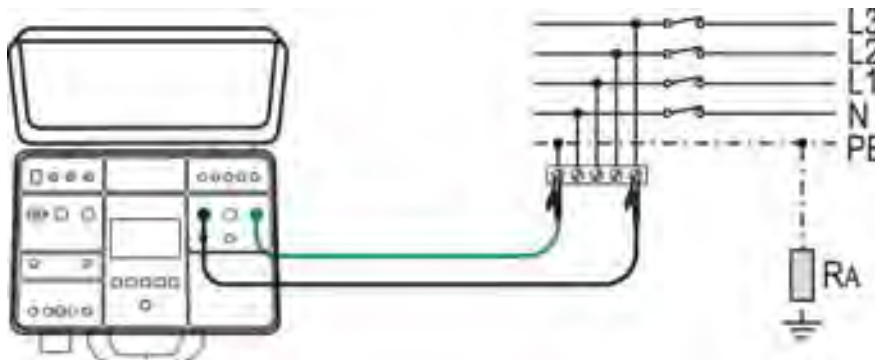

Fig. 48 : Connection with test leads for LOOPP/PE test

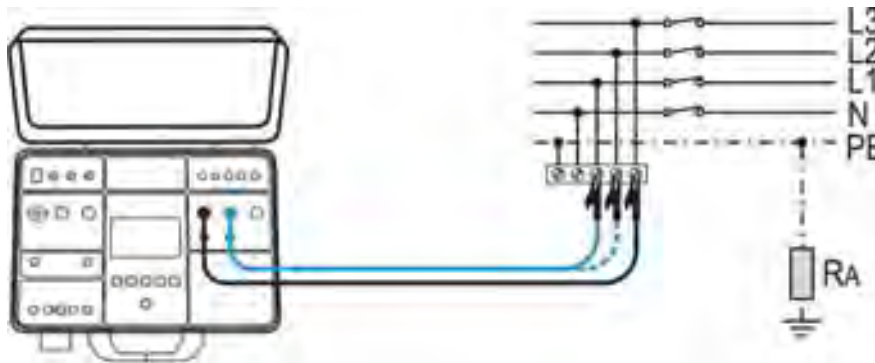

Fig. 49 : Connection with test leads for LOOP/P test

9. Press the **START/STOP** key to perform the measurement. The test result is shown on the display (see Fig. 50)

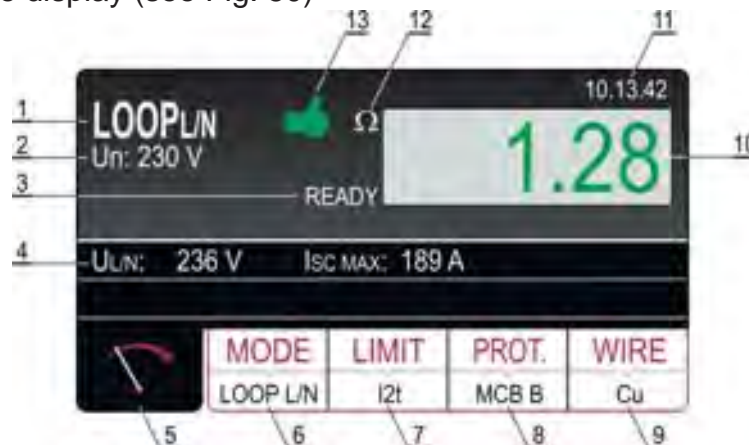





Fig. 50 : Visualization of LOOP test result

Meaning of symbols on the display

Item	Description
1	Selected function
2	Selected nominal voltage needed for calculation of short-circuit current
3	READY message. It is displayed when present mains voltage $U_{L/L}$, $U_{L/N}$ or $U_{L/PE}$ within required range is present.
4	Sub-results - mains voltage $U_{L/PE}$ or $U_{L/L}$ or $U_{L/PE}$ at which the measurement has been done and calculated prospective short-circuit current ISC
5	Measurement screen touch-screen key
6	MODE touch-screen key to select measurement mode (LOOP L/N, LOOP L/L, LOOP L/PE, IMP57 L/N, IMP57 L/L or IMP57 L/PE). Currently selected mode is displayed on the bottom of the key
7	LIMIT touch-screen key to select limit mode (STD, kA, I^2t , TRIP CURR. or U_t). Currently selected mode is displayed on the bottom of the key
8	PROT. (protection) touch-screen key to select the type of protection (MCB B, MCB C, MCB D, MCB K, FUSE gG or FUSE aM) and nominal current of selected protection. Currently selected type is displayed on the bottom of the key

Item	Description
9	WIRE touch-screen key to select the material of measured wire (Cu or Al), coating (PVC, BUTYL RUBBER or EPR/XLPE), section (1, 1.5, 2.5, 4, 6, 10, 16, 25, 35, 50, 70, 95, 120, 150, 185, 240, 300, 400, 500 or 630 mm ²) and number of conductors (1 ÷ 99). Currently selected material is displayed on the bottom of the key
10	Measurement result (in green color - result OK, in red color - result not OK).
11	Real time clock (hh.mm.ss)
12	Unit of the test result (Ω)
13	Measurement result status (symbol  in green color - result OK, symbol  in red color - result not OK)

10. READY message will appear when mains voltage UL/N (LOOP L/N) or UL/PE (LOOP L/PE) within 100V ÷ 265V or UL/L (LOOP L/L) within 100V ÷ 460V is present. Carry out the measurement by pressing the **START/STOP** button
11. Test result (loop impedance) will be displayed in green color equipped with green  symbol and with beep-beep sound if measured/calculated ISC corresponds to entered limit mode and other entered parameters. If measured/calculated ISC does not correspond to entered limit mode and other entered parameters the result will be displayed in red color equipped with red  symbol and with longer acoustic sound
12. Save the test result by pressing the **SAVE** key (see § 7.1)





CAUTION



- In case voltage UL/N (LOOP L/N measurement) or voltage UL/PE (LOOP L/PE measurement) within required range 100V ÷ 265V is present at L/N/PE test terminals (also displayed) but there is no READY message displayed, check if energizing socket is correctly earthed
- In case voltage UL/L (LOOP L/L measurement) within required range 100V÷460V is present at L/N test terminals (also displayed) but there is no READY message displayed, check if energizing socket is correctly earthed
- If limit mode STD is selected (result is not evaluated), then the result will be displayed in white color

6.6.3. Anomalous situations

The following specific information can be shown on the display during measurement

Information displayed	Description
 VOLTAGE OUT OF RANGE	Input voltage UL/N or UL/PE out of required range 100V ÷ 265V (L/N or L/PE measurement) or out of required range 100÷460V (L/L measurement) after pressing the START/STOP key
 FUSE F3!	Fuse F3 is blown.
 HOT!	Internal load is overheated. <i>Wait to cool it down!</i>
 MEASUREMENT FAILED!	Input voltage failed during the measurement (disconnection of test leads, installation fuse tripped etc.)

6.7. GLOBAL EARTH RESISTANCE/CONTACT VOLTAGE (RA \downarrow)

The instrument allows the measurement of the global earth resistance (a measurement typically used in TT type electrical systems - civil installations as an alternative to the earth measurement with the voltamperometric method) by applying a test current of $I_{\Delta N} / 2$ in which $I_{\Delta N}$ = rated tripping current of the differential (RCD) and therefore, in the absence of ground leakage, without causing the intervention of the RCD.

1. Press the **FUNC** key and select the **RA \downarrow** function. The following screen is shown on the display

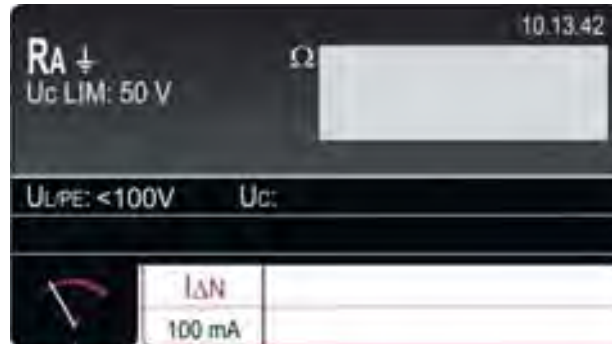

Fig. 51 : RA \downarrow initial screen

2. Select the test parameters on the instrument (see Table 9) and carry out the desired setup

Parameter	Description	Value
$I_{\Delta N}$	Nominal trip out current of RCD	10,30,100,300,500,650,1000mA

Table 9 : Setup parameters of RA \downarrow function

6.7.1. Limit value setting

In accordance with safety guidelines the global earth resistance RA must be less than or equal to the **UCLIM/I ΔN** ratio where the limit contact voltage UCLIM can be set to 25V or 50V. Example: UCLIM selected = 50V, $I_{\Delta N}$ = 30mA \rightarrow RALIM = 1667

How to select limit contact voltage UC LIM. (see § 5.5). Press the **MENU** \rightarrow **SETUP** \rightarrow **CONTACT VOL.** touch-screen keys and select 25V or 50V.

3. Check selected nominal differential current and modify it if needed by pressing the **I ΔN** touch-screen key first.
4. Select measurement screen by pressing the touch-screen key and check all settings again
5. Connect the test leads or the Shuko cable according to one of below figures:

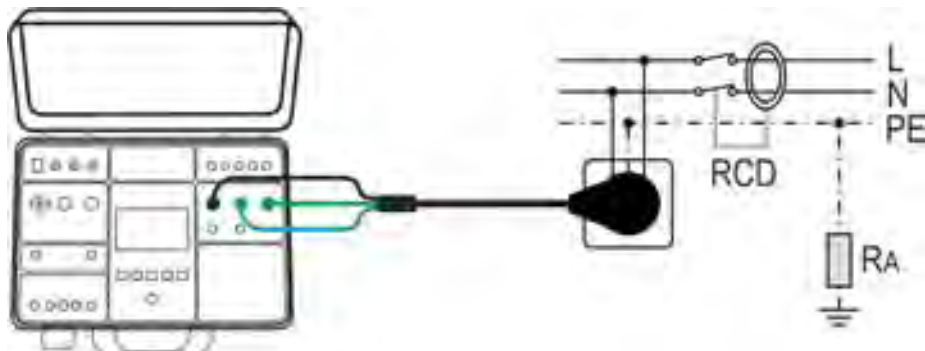

Fig. 52 : Connection with schuko cable for RA test

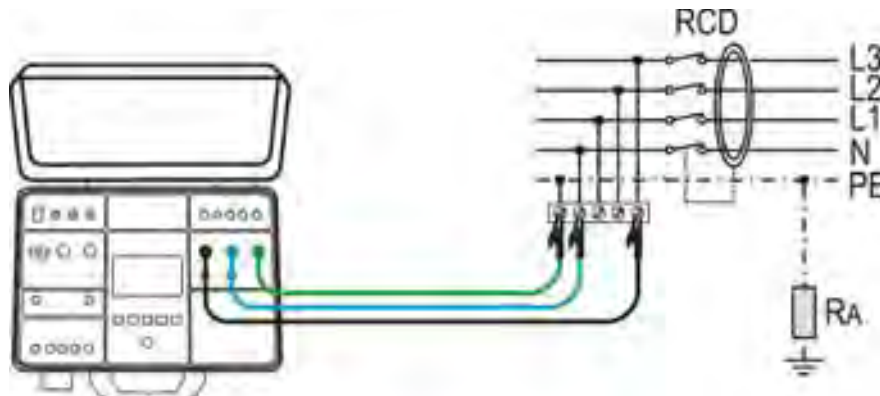

Fig. 53 : Connection with test leads for RA test

6. Press the **START/STOP** key to perform the measurement. The test result is shown on the display (see Fig. 54)

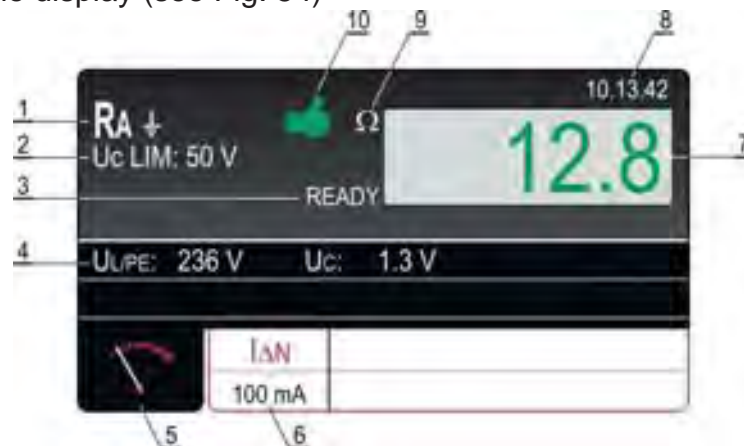





Fig. 54 : Visualization of RA test result

Meaning of symbols on the display

Item	Description
1	Selected function
2	Selected limit contact voltage (25V or 50V)
3	READY message. It is displayed when mains voltage $U_{L/PE}$ within $100V \div 265V$ is present
4	Sub-results, mains voltage $U_{L/PE}$ at which the measurement was carried out and contact voltage U_c at nominal differential current
5	Measurement screen touch-screen key

Item	Description
6	I Δ N touch-screen key to select nominal differential current. Currently selected value is displayed in the bottom of the key
7	Measurement result (in green color - result OK, in red color - result not OK).
8	Real time clock (hh.mm.ss)
9	Unit of the test result
10	Measurement result status (symbol  in green color - result OK, symbol  in red color - result not OK)

7. Test result will be displayed after elapsing measurement time in green colour equipped with green  symbol and with beep-beep sound if it is lower than or equal to limit value (see the explanation of limit value above). If the result is higher than limit value, then it will be displayed in red color equipped with red  symbol and with longer acoustic sound
8. Save the test result by pressing the **SAVE** key (see §)







CAUTION



In case voltage UL/PE within required range 100 ÷ 265 V is present between L and PE test terminals (also displayed) but there is no READY message displayed, check if energizing socket is correctly earthed

6.7.2. Anomalous situations

The following specific information can be shown on the display during measurement

Information displayed	Description
 VOLTAGE OUT OF RANGE!	Input voltage UL/PE out of required range 100 ÷ 265 V after pressing the START key.
 CONTACT VOLTAGE > 50V or  CONTACT VOLTAGE > 25V	Contact voltage higher than selected limit value, probably due to too high loop resistance.
 MEASUREMENT FAILED!	Measurement current was interrupted either due to disconnection of test leads or due to increase of loop resistance.
 FUSE F3!	Fuse F3 is blown.
 HOT!	Internal circuitry is overheated. <i>Wait to cool it down!</i>

6.8. RESIDUAL VOLTAGE (URES)

Residual voltage means the voltage that remains on accessible parts of a machine after it has been turned off. This phenomenon can be caused for example by integrated capacities or internal generators and must be kept within appropriate values for operator safety reasons. In accordance with the requirements of IEC/EN60204-1 guideline, accessible live parts connected to dangerous voltages must discharge **within 5s** (machines permanently powered) or **within 1s** (machines connected with plugs, terminal blocks, drives, etc.) **up to 60V**. This must be verified by means of appropriate evaluation tests of the discharge time. In the event of non-compliance, additional measures must be taken (discharge devices, warning information, covers, etc.). The residual voltage must be measured 1s or 5s after turning off the tested machine. The instrument can perform the URES measurement in the following modes:

- **Linear** mode on plug-in machines (**Plug**)
- **Linear** mode on permanently connected machines (**Internal**)
- **Non-Linear** mode on plug-in machines (**Plug**)
- **Non-Linear** mode on permanently connected machines (**Internal**)

6.8.1. Linear mode

In **Linear** mode it is considered that the internal components of the machine are exclusively "linear" (resistances, inductances, capacitances, etc.) therefore the discharge characteristic of the supply voltage is typically inverse exponential. In this way the displayed result refers to the **peak value** of the supply voltage so as to evaluate the most critical situation (see

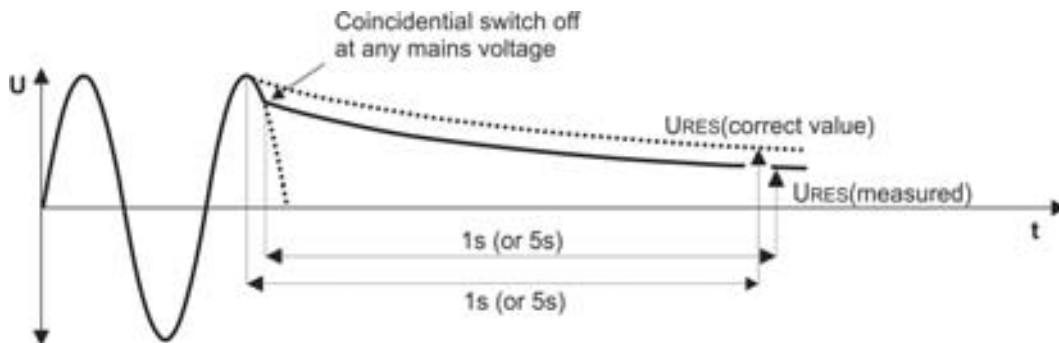

Fig. 55 : Discharge supply voltage in linear mode

In order to calculate the measured URES voltage it is necessary to know the nominal value of the supply voltage **Un** Phase-Neutral or Phase-Earth therefore it is necessary to select it on the instrument before performing the measurements (see § 5.5). The instrument automatically detects the below standard system voltages (e.g. 230V/240V)

- Nominal voltage selected $U_n = 230V$
 $230V \rightarrow U_{IN} = 230V \pm 10\%$
 $400V \rightarrow U_{IN} = 400V \pm 10\%$
- Nominal voltage selected $U_n = 240V$
 $240V \rightarrow U_{IN} = 240V \pm 10\%$
 $415V \rightarrow U_{IN} = 415V \pm 10\%$

In order to include standard mains over-voltage, the measured residual voltage is scaled to peak value of max. possible mains over-voltage, i.e.:

- Nominal voltage selected $U_n = 230V$
- $U_p = 230V \times 1.1 \times \sqrt{2} = 358V \rightarrow$ system voltage 230V is recognized
- $U_p = 400V \times 1.1 \times \sqrt{2} = 620V \rightarrow$ system voltage 400V is recognized

If actual mains voltage differs from nominal system voltage more than $\pm 10\%$, the instrument scales the result to peak value of actual input voltage.

Example 1 ($U_n = 230V$):

$U_{IN} = 173V$ (the value differs more than 10% from 230V), result is scaled to $173V \times \sqrt{2} = 244V$

Example 2 ($U_n = 230V$):

$U_{IN} = 209V$ (the value differs less than 10% from 230V), result is scaled to $230V \times 1.1 \times 1.41 = 358V$

6.8.2. Non-Linear mode

In non-linear mode it is assumed there are also "non-linear" or unknown components involved in discharge process (relays, gas lamps etc.) and therefore discharge characteristic is non-exponential or it is unpredictable (see Fig. 56)

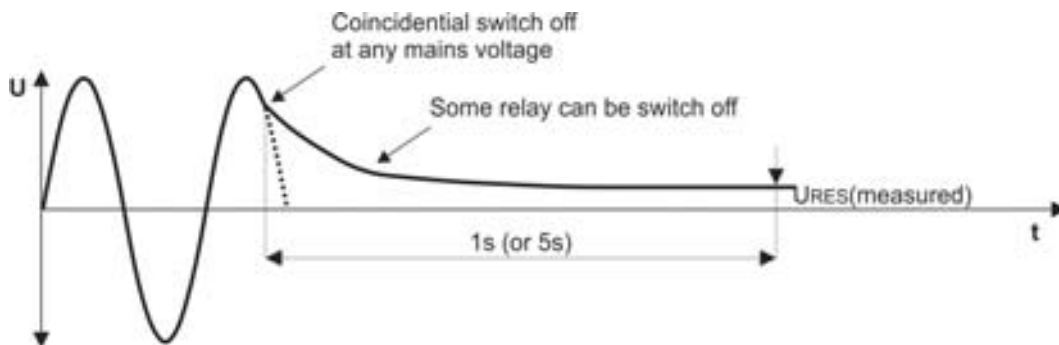

Fig. 56 : Discharge supply voltage in Non-Linear mode

In this case result cannot be scaled to peak value, so it must be assured that switch off occurs at max. input voltage i.e. at pick value otherwise measured result is not relevant. Measured value is then registered and evaluated.

6.8.3. Trigger conditions

The instrument recognizes disconnection of mains voltage on TRIG input (INT measurement) or on URES input (PLUG measurement) when one of the following two conditions occurs:

- If mean value of rectified input voltage drops down with a **slope of at least 25V/s** (measured each period), then trigger is activated and the measurement starts to run (this condition will occur for example if AC or DC input voltage starts to decrease)
- Momentary value of current half period is compared with momentary value of previous half period (the same polarity). If there is a difference **higher than 10%**, then trigger is activated and the measurement starts to run (this condition will occur for example if AC voltage changes to DC)
- The above two conditions are active on URES input in PLUG mode and on UTRIG input in INT mode

1. Press the **FUNC** key and select the **URES** function. The following screen is shown on the display

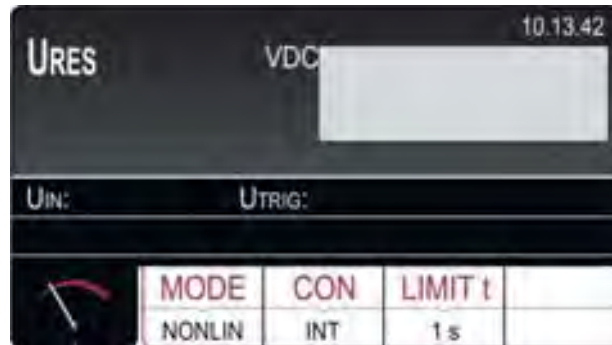



Fig. 57 : URES initial screen

2. Select the test parameters on the instrument (see Table 10) and carry out the desired setup

Parameter	Description	Value
MODE	Measurement mode	LIN (Linear), NONLIN (Non-Linear)
CON	Type of connection	INT (measure on internal component), PLUG (measure on 1Phase/3Phase plug)
LIMIT t	Limit time	1s, 5s

Table 10 : Setup parameters of URES function

3. Check selected mode and modify it if needed by pressing the **MODE** touch-screen key first
4. Check selected connection and modify it if needed by pressing the **CON** touch-screen key first
5. Check selected limit time and modify it if needed by pressing the **LIMIT t** touch-screen key first
6. Select measurement screen by pressing the  touch-screen key and check all settings again
7. Connect test leads according to one of the below figures

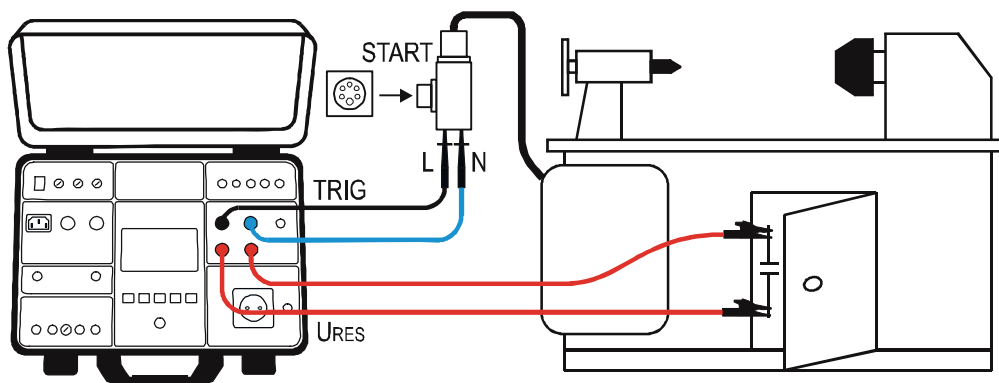

Fig. 58 : Connection for URES INT measurement on 1P/3P plugged machines

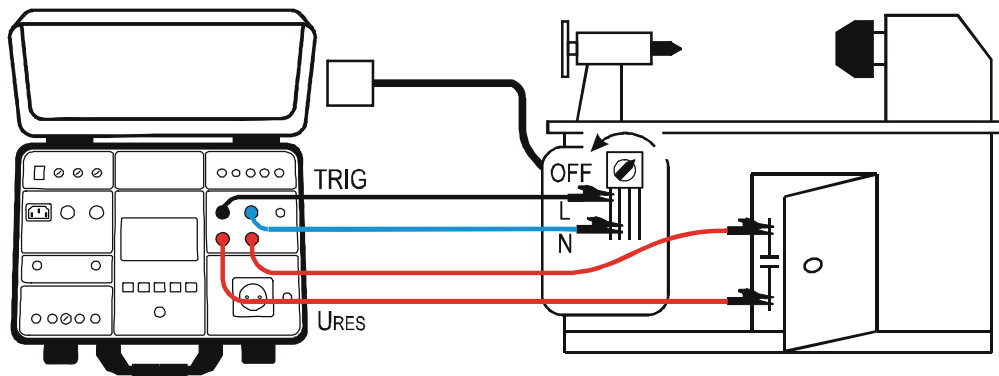

Fig. 59 : Connection for URES INT measurement on fixed connected machines

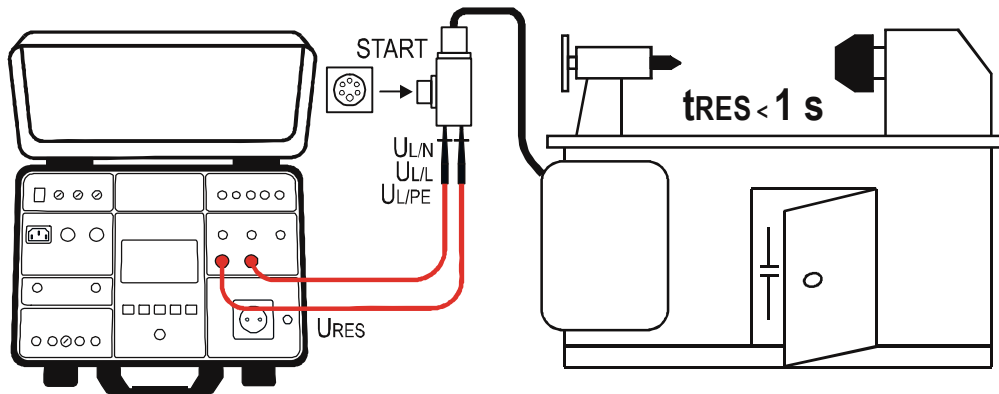

Fig. 60 : Connection for URES PLUG measurement

8. READY, DISCONNECT UUT message will appear when UTRIG voltage within required range $100V \div 460VAC$ is present. Carry out the measurement by disconnecting the UUT. The below screen is shown at display:

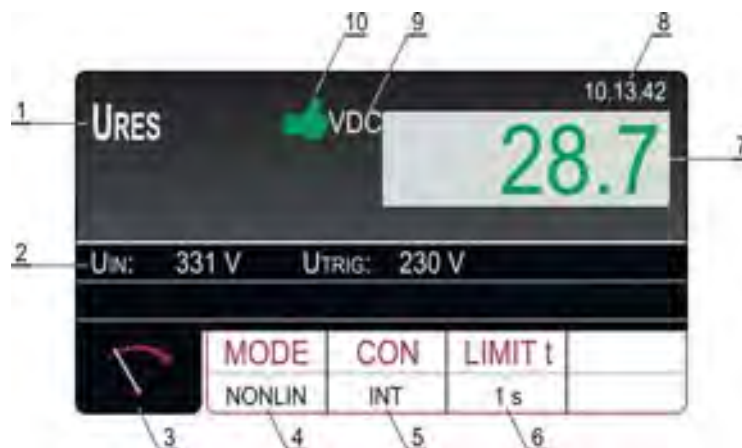



Fig. 61 : Visualization of URES test result

Meaning of symbols on the display

Item	Description
1	Selected function
2	Input voltage U_{IN} and trigger voltage U_{TRIG}
3	Measurement screen touch-screen key
4	MODE touch-screen key to select measurement mode (LINEAR or NONLINEAR). Currently selected mode is displayed on the bottom of the key

Item	Description
5	CON (connection) touch-screen key to select measurement connection (INT or PLUG). Currently selected connection is displayed on the bottom of the key
6	LIMIT t touch-screen key to select limit time (1 s or 5 s), valid for internal measurement only. Currently selected limit value is displayed on the bottom of the key
7	Measurement result (in green colour - result OK, in red colour - result not OK)
8	Real time clock (hh.mm.ss).
9	Unit of the test result. As measured URES voltage may be alternating or direct there is an appropriate information AC or DC added to the unit
10	Measurement result status (symbol  in green colour - result OK, symbol  in red colour - result not OK)

9. Save the test result by pressing the **SAVE** key (see § 7.1)





CAUTION

Do not use the START/STOP button in this function, it has no function

6.8.4. Anomalous situations

The following specific information can be shown on the display during measurement

Information displayed	Description
 LOW TRIGGER VOLTAGE REPEAT	Mains voltage was disconnected at too low momentary voltage (< 20% of peak value). The message may appear in LINEAR mode only. <i>Repeat the measurement (connect and disconnect the UUT again)!</i>
 LOW SWITCH-OFF VOLTAGE REPEAT	Mains voltage was not disconnected close enough to peak value ($U_p \pm 5\%$) so the result would be not relevant anyway. The message may appear in NONLINEAR mode only. <i>Repeat the measurement (connect and disconnect the UUT again)!</i>

6.9. FUNCTIONAL TEST (POWER)

The instrument allows to perform routine functional tests on equipment directly connected to the schuko test socket on the front panel (see Fig. 2 - part 25). In this case the instrument supplies the UUT and measures its parameters: voltage, current, active power, apparent power, power factor (PF) and leakage current on the plug.

1. Press the **FUNC** key and select the **POWER** function. The following screen is shown on the display

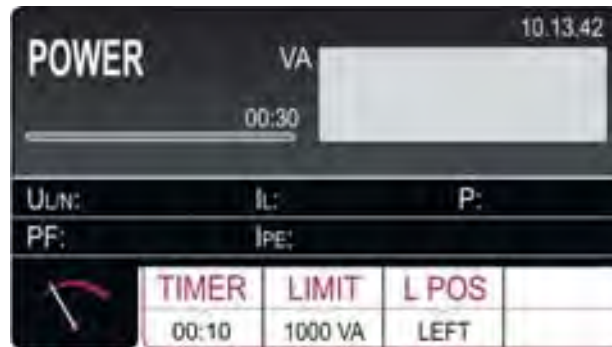

Fig. 62 : POWER initial screen

2. Select the test parameters on the instrument (see Table 11) and carry out the desired setup

Parameter	Description	Value
TIMER	Measurement time	5s ÷ 60min, resolution 1s
LIMIT	UUT apparent power limit value	6VA ÷ 5.06kVA
L POS	Position of Phase terminal on the schuko test socket	LEFT / RIGHT

Table 11 : Setup parameters of POWER function

3. Check selected measurement time and modify it if needed by pressing the **TIMER** touch-screen key first. Four independent preset measurement times are available for quicker operations. Select the closest one and modify it by using the **+** and **—** touch screen keys if needed
4. Check selected limit apparent power and modify it if needed by pressing the **LIMIT** touch-screen key first. Four independent preset limit values are available for quicker operations. Select the closest one and modify it by using the **+** and **—** touch screen keys if needed
5. Check selected position of phase terminal on schuko socket by pressing the **L POS** touch-screen key. If **LEFT** position is selected then phase potential is connected to the left terminal of schuko socket and vice versa
6. Select measurement screen by pressing the touch-screen key and check all settings again
7. Connect the UUT to schuko socket according to the below

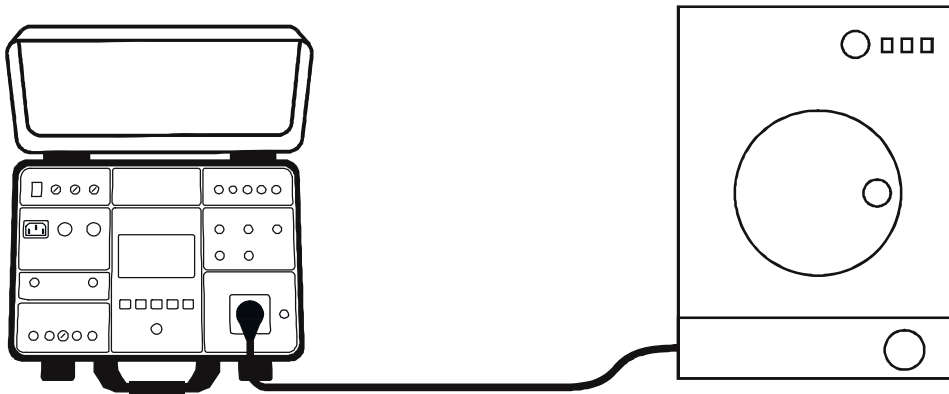

Fig. 63 : Connection of UUT to schuko test socket

8. Start the measurement by pressing the **START/STOP** key. The measurement will start to run and will be stopped after pressing the **START/STOP** key again or after elapsing set measurement time
9. Test result (apparent power) will be currently displayed in green color if it is lower than or equal to set limit value or in red color if it is higher than set limit value. Final result will be equipped with green 👍 symbol and with beep-beep sound if it is OK or with red 🚫 symbol and with longer sound if it is not OK. See the display outlook with test result on the

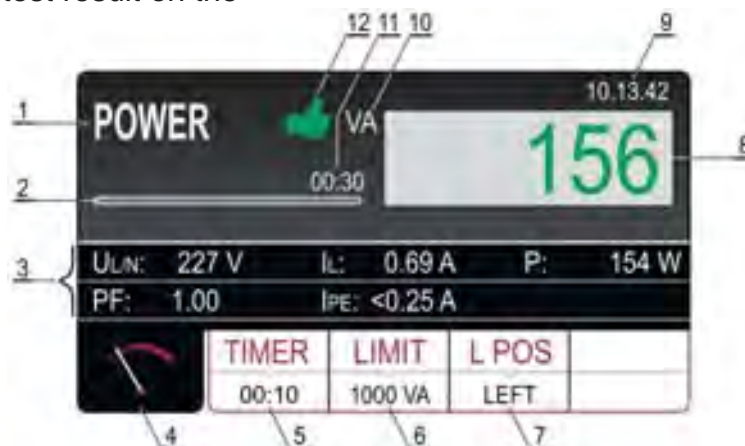



Fig. 64 : Visualization of POWER test result

Meaning of symbols on the display

Item	Description
1	Selected function
2	Progress bar. It follows measurement time during the measurement
3	Two lines reserved for sub-results as follows: Mains voltages UL/N, Load current IL, Real power P, Power factor PF and Leakage current IPE
4	Measurement screen touch-screen key
5	TIMER touch-screen key to adjust measurement time. Currently selected measurement time is displayed on the bottom of the key
6	LIMIT touch-screen key to select limit apparent power. Currently selected value is displayed on the bottom of the key

Item	Description
7	L POS touch-screen key to select the position of phase terminal on schuko socket during the measurement. Currently selected position is displayed on the bottom of the key
8	Measurement result (in green colour - result OK, in red colour - result not OK).
9	Real time clock (hh.mm.ss).
10	Unit of the test result
11	Set measurement time
12	Measurement result status (symbol  in green colour - result OK, symbol  in red colour - result not OK)

10. Save the test result by pressing the **SAVE** key (see § 7.1)

CAUTION



- **Measurement at both phase positions (phase at left terminal and phase at right terminal) must be carried out when leakage current IPE is measured and the highest value must be evaluated**
- **Switch on the UUT in order full power of the unit and total leakage current to be measured**
- **In case of overloaded test socket the fuse F1 or F2 (both T16A/250V) may blow**
- **Do not use test schuko socket except for measurement purpose**

6.9.1. Anomalous situations

The following specific information can be shown on the display during measurement

Information displayed	Description
IPE > 3.5 mA	Leakage current IPE is higher than 3.5 mA what may be dangerous for the operator. The message will appear always when the current exceeds the 3.5mA threshold and will automatically disappear after 10 s. For more obvious warning the message is accompanied with audio beep-beep signal.
IPE CURRENT OVERRANGE!	If IPE current is higher than 10 A for 10 s, the measurement will be stopped and this message will appear.
IL CURRENT OVERRANGE!	If IL current is higher than 16 A for 10 s, the measurement will be stopped and this message will appear.

6.10. PHASE SEQUENCE TEST (PHASESEQ)

The instrument allows to perform the phase sequence sense test in a three-phase system with the traditional 3-wire method.

1. Press the **FUNC** key and select the **PHASESEQ** function. The following screen is shown on the display



Fig. 65 : PHASESEQ initial screen

2. Connect the test leads to tested socket/wiring according to the Fig. 66

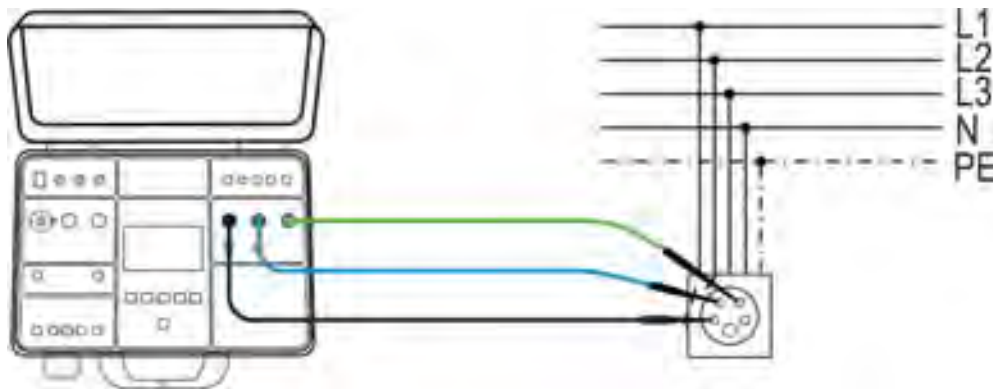

Fig. 66 : Connection of test leads in PHASE SEQUENCE measurement

3. Carry out the measurement by pressing the **START/STOP** key. The measurement will be done and test result will be displayed in green color equipped with green symbol and with acoustic sound if it is in accordance with referential direction (**1.2.3. indication**). If the result is not in accordance with referential direction (**2.1.3. indication**) then it will be displayed in red color equipped with red symbol and with longer acoustic sound. See the display outlook with test result on the



Fig. 67 : Visualization of PHASE SEQUENCE test result

Meaning of symbols on the display

Item	Description
1	Selected function
2	Measurement sub-results as follows: Phase-to-phase voltage $U_{L1/2}$, phase-to-phase voltage $U_{L2/3}$ and phase-to-phase voltage $U_{L3/1}$
3	Measurement screen touch-screen key
4	Measurement result (in green colour - result OK, in red colour - result not OK)
5	Real time clock (hh.mm.ss).

4. Save the test result by pressing the **SAVE** key (see § 7.1)

6.10.1. Anomalous situations

The following specific information can be shown on the display during measurement

Information displayed	Description
VOLTAGE OUT OF RANGE	One of more input phase-phase voltages is out of required range 100V ÷ 460V
1.1.X	At least one of measured phases was disconnected during the measurement. <i>Connect all three phases and repeat the measurement.</i>

6.11. CURRENT MEASUREMENT WITH TRANSDUCER CLAMP (ICLAMP)

The instrument allows the measurement of AC current by using a transducer clamp (optional accessory HT96U) connected to the ILEAK input (see Fig. 2 - part 26).

1. Press the **FUNC** key and select the **ICLAMP** function. The following screen is shown on the display

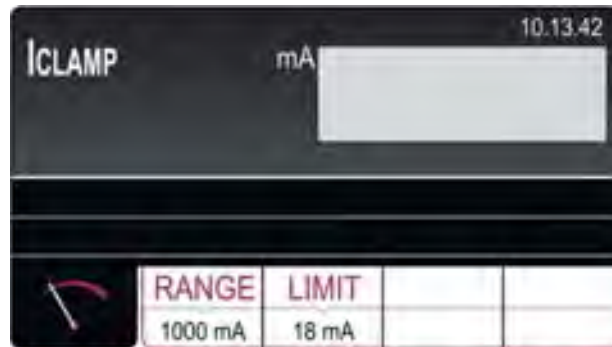

Fig. 68 : ICLAMP initial screen

2. Select the test parameters on the instrument (see Table 12) and carry out the desired setup

Parameter	Description	Value
RANGE	Measurement range	1000mA,100A,1000A
LIMIT	Limit value of measurement	0.1mA ÷ 1000mA (1000mA) 0.1A ÷ 100.0A (100A) 1.0A ÷ 1000A (1000A)

Table 12 : Setup parameters of ICLAMP function

3. Check selected measurement range and modify it if needed by pressing the **RANGE** touch-screen key first
4. Check selected limit current and modify it if needed by pressing the **LIMIT** touch-screen key first. Four independent preset limit values are available for quicker operations. Select the closest one and modify it by using the **+** and **-** touch screen keys if needed
5. Select measurement screen by pressing the touch-screen key and check all settings again
6. Connect current clamp to measured wiring according to the Fig. 69

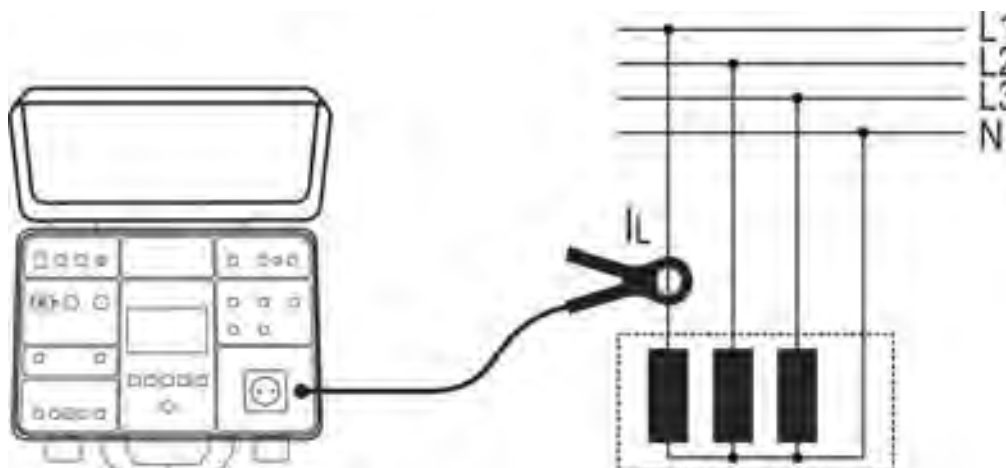

Fig. 69 : Connection of current clamp in ICLAMP measurement

7. Start the measurement by pressing the **START/STOP** key. The measurement will start to run and will be stopped after pressing the **START/STOP** key again. Measurement result will be currently displayed in green color if it is lower than or equal to set limit value or in red color if it is higher than set limit value. Final result will be equipped with green symbol and with acoustic sound if it is OK or with red symbol and with longer acoustic sound if it is not OK. See the display outlook with test result in Fig. 70



Fig. 70 : Visualization of ICLAMP test result

Meaning of symbols on the display

Item	Description
1	Selected function
2	Measurement screen touch-screen key
3	RANGE touch-screen key to select measurement range (0 ÷ 1000 mA, 0 ÷ 100 A or 0 ÷ 1000 A)
4	LIMIT touch-screen key to select limit current value inside each measurement range
5	Measurement result (in green color - result OK, in red color - result not OK)
6	Real time clock (hh.mm.ss).
7	Measurement unit of result
5	Measurement result status (symbol in green color - result OK, symbol in red color - result not OK.)

8. Save the test result by pressing the **SAVE** key (see § 7.1)



CAUTION

- Max input voltage is 10 V, one terminal is grounded
- Measurement time is limited to 60 min

6.11.1. Anomalous situations

The following specific information can be shown on the display during measurement

Information displayed	Description
CURRENT OVERRANGE	If IL current is higher than 10 A for 10s, the measurement will be stopped and this message will appear

6.12. LEAKAGE CURRENT (ILEAK)

The instrument allows the measurement of the AC leakage current both with the use of a transducer clamp (optional accessory HT96U) connected to the ILEAK input (see Fig. 2 - part 26) and on equipment directly connected to the schuko test socket on the front panel (see Fig. 2 - part 25). In this case the instrument powers the UUT and measures the leakage current on the plug.

1. Press the **FUNC** key and select the **ILEAK** function. The following screen is shown on the display



Fig. 71 : ILEAK initial screen

2. Select the test parameters on the instrument (see Table 13) and carry out the desired setup

Parameter	Description	Value
MODE	Measurement mode	CLAMP or SOCKET
RANGE	Measurement range of clamp	1000mA,100A,1000A
LIMIT	Limit value on measurement with HT96U	0.1mA ÷ 1000mA (1000mA) 0.1A ÷ 100.0A (100A) 1.0A ÷ 1000A (1000A)
	Limit value on measurement with connection to test socket	0.25mA ÷ 10.0A
L POS	Position of Phase terminal on the schuko test socket	LEFT / RIGHT

Table 13 : Setup parameters of ILEAK function

Use of transducer clamp HT96U

3. Select CLAMP mode by pressing the **MODE** touch-screen key first
4. Check selected measurement range and modify it if needed by pressing the **RANGE** touch-screen key first
5. Check selected limit leakage current by pressing the **LIMIT** touch-screen key first. Four independent limit values are available for quicker operations. Select the closest one and modify it by using the **+** and **-** touch screen keys if needed
6. Select measurement screen by pressing the  touch-screen key and check all settings again
7. Connect the current clamp to measured wiring according to the

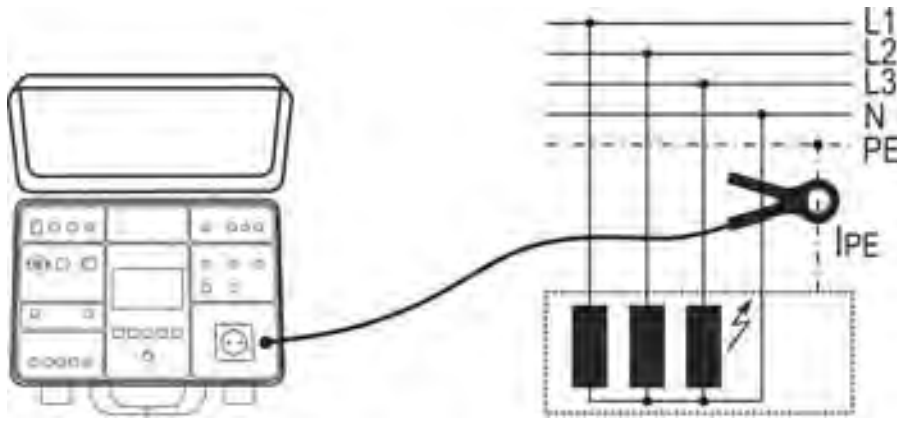

Fig. 72 : Connection of current clamp in ILEAK measurement

8. Start the measurement by pressing the **START/STOP** key. The measurement will start to run and will be stopped after pressing the **START/STOP** key again. Measurement result will be currently displayed in green color if it is lower than or equal to set limit value or in red color if it is higher than set limit value. Final result will be equipped with green 🍏 symbol and with acoustic sound if it is OK or with red 🍏 symbol and with longer acoustic sound if it is not OK. See the display outlook with test result on the Fig. 73

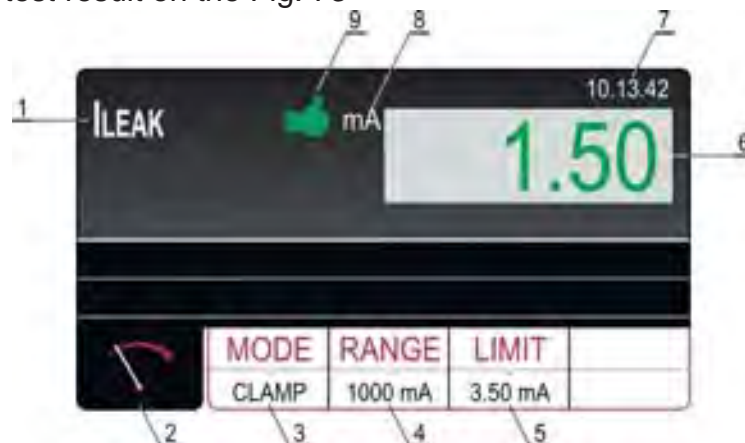



Fig. 73 : Visualization of ILEAK test result

Meaning of symbols on the display

Item	Description
1	Selected function
2	Measurement screen touch-screen key
3	MODE touch-screen key to select measurement mode (CLAMP). Currently selected mode is displayed on the bottom of the key
4	RANGE touch-screen key to select the CLAMP measurement range. Currently selected range is displayed on the bottom of the key
5	LIMIT touch-screen key to select limit leakage current. Currently selected value is displayed on the bottom of the key
6	Measurement result (in green colour - result OK, in red colour - result not OK).
7	Real time clock (hh.mm.ss).
8	Measurement unit of result
9	Measurement result status (symbol 🍏 in green color - result OK, symbol 🍏 in red color - result not OK.)

- Save the test result by pressing the **SAVE** key (see § 7.1)

Use of test socket

- Select SOCKET mode by pressing the **MODE** touch-screen key first
- Check selected limit leakage current by pressing the **LIMIT** touch-screen key first. Four independent limit values are available for quicker operations. Select the closest one and modify it by using the **+** and **-** touch screen keys if needed
- Check selected position of phase terminal on schuko socket by pressing the **L POS** touch-screen key. If LEFT position is selected then phase potential is connected to left terminal of schuko socket and vice versa
- Select measurement screen by pressing the  touch-screen key and check all settings again
- Connect the UUT to schuko socket according to the Fig. 74

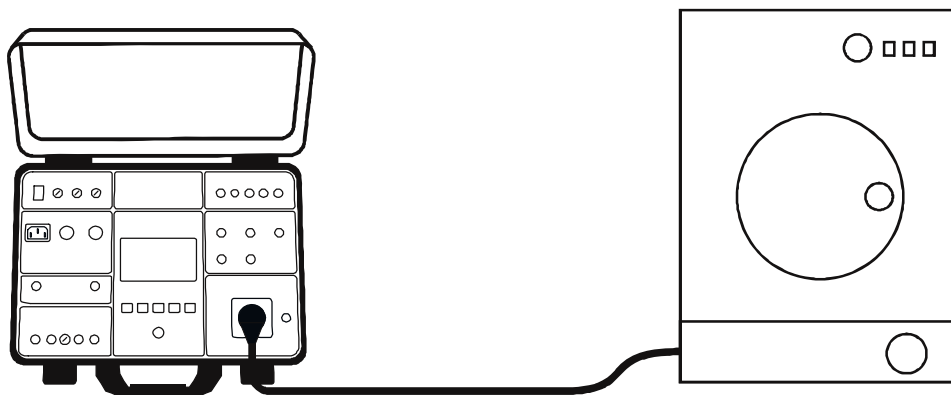

Fig. 74 : Connection of current clamp in ILEAK measurement – SOCKET mode





- Start the measurement by pressing the **START/STOP** key. The measurement will start to run and will be stopped after pressing the **START/STOP** key again. Measurement result will be currently displayed in green color if it is lower than or equal to set limit value or in red color if it is higher than set limit value. Final result will be equipped with green  symbol and with beep-beep sound if it is OK or with red  symbol and with longer beep sound if it is not OK. See the display outlook with test result in Fig. 75



Fig. 75 : Visualization of ILEAK test result – SOCKET mode

Meaning of symbols on the display

Item	Description
1	Selected function
2	Sub-result, mains voltage UL/N
3	Measurement screen touch-screen key
4	MODE touch-screen key to select measurement mode (SOCKET) Currently selected mode is displayed on the bottom of the key
5	LIMIT touch-screen key to select limit leakage current. Currently selected value is displayed on the bottom of the key
6	L POS touch-screen key to select the position of phase terminal on schuko socket during the measurement. Currently selected position is displayed on the bottom of the key
7	Measurement result (in green colour - result OK, in red colour - result not OK).
8	Real time clock (hh.mm.ss)
9	Unit of the test result
10	Measurement result status (symbol  in green colour - result OK, symbol  in red colour - result not OK).

9. Save the test result by pressing the **SAVE** key (see § 7.1)

CAUTION



- **Measurement at both phase positions (phase at left terminal and phase at right terminal) must be carried out and the highest value must be evaluated**
- **Switch on the UUT in order total leakage current to be measured**
- **In case of overloaded test socket the fuse F1 or F2 (both T16A/250V) may blow**
- **Do not use test schuko socket except for measurement purpose**
- **Measurement time (SOCKET) is limited to 60 min**

6.12.1. Anomalous situations

The following specific information can be shown on the display during measurement

Information displayed	Description
IPE CURRENT OVERRANGE!	If IPE current is higher than 10A for 10s, the measurement will be stopped and this message will appear

6.13. EXECUTION OF AN AUTOTEST

The instrument allows you to execute Autotest sequences predefined in the main Menu (see § 5.7).

1. Press the **FUNC** key and select the **AUTO TEST** function. The screen of is shown on the display



Fig. 76 : AUTO TEST Function - Initial screen

2. Use the ▲ or ▼ arrow keys to select the desired Autotest (ex: Insulation measurement with 500VDC test voltage and 3 tests included) and touch the **SELECT** key or directly the corresponding line. The "0 / X" message in which X = number of tests included in the Autotest indicates that no internal test has been performed. The screen of Fig. 76 - right side is shown on the display
3. Connect the instrument to the first circuit under test (ex: consider the Insulation measurement of § 6.3)
4. Press the **START/STOP** key twice to activate the "01" test of the Autotest
5. Press the **START/STOP** key again to end the "01" test. The instrument will save the first partial result of the Autotest and automatically prepares itself for the execution of the next "02" test (see Fig. 77)
6. Press the **COMMENT** key to include a possible comment to the 01 test

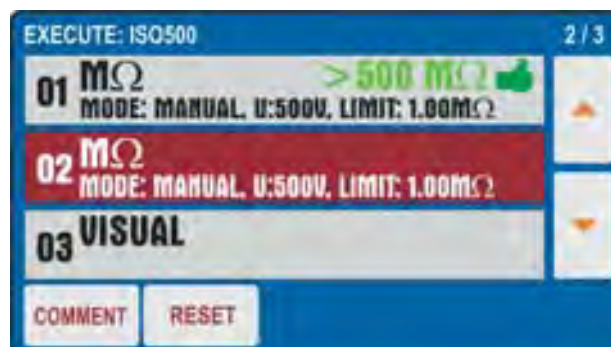

Fig. 77 : AUTO TEST Function - Partial result test 01

7. Connect the test leads to the second circuit under test
8. Press the **START/STOP** key twice to activate the "02" test of the Autotest
9. Press the **START/STOP** key again to end the "02" test. The instrument will save the first partial result of the Autotest and automatically prepares itself for the execution of the next "03" test (see Fig. 78)
10. Press the **COMMENT** key to include a possible comment to the 02 test

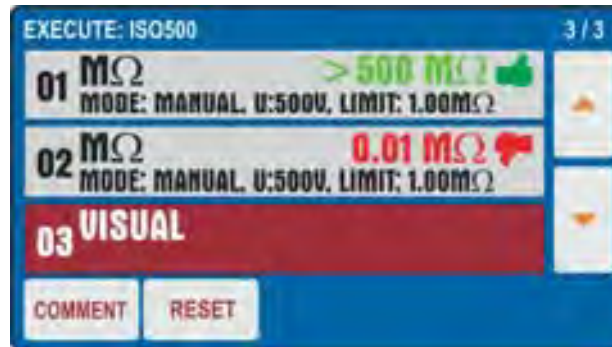

Fig. 78 : AUTO TEST Function - Partial result test 02

11. Press the **START/STOP** key twice to activate the "03" test of the Autotest which in the example considered is the **VISUAL** function which indicates the Pass or Failed result of the test inserted by the operator (see Fig. 79 - left side)
12. Press the **COMMENT** key to include a possible comment to the 03 test

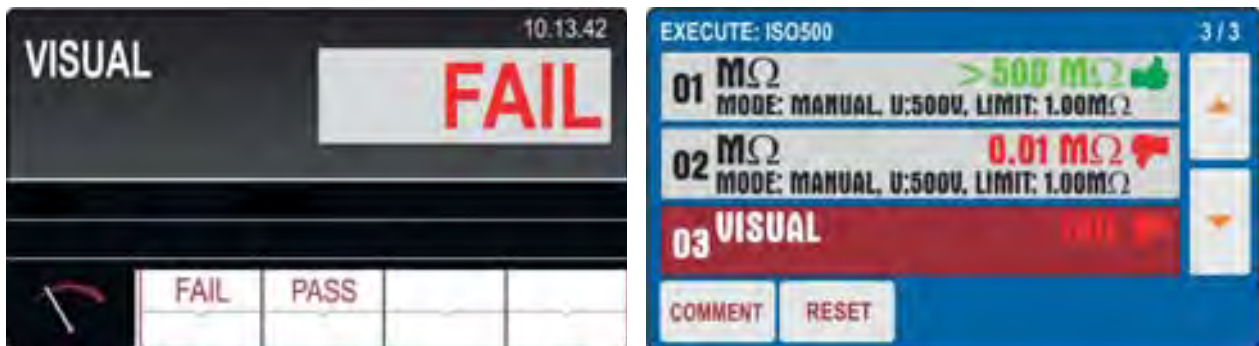

Fig. 79 : AUTO TEST Function - Final result

13. At the end of the Autotest the instrument has a final screen similar to that shown in Fig. 79 - right side
14. Save the test result by pressing the **SAVE** key (see § 7.2)
15. Press the **RESET** key to delete the measurement results restoring the initial Autotest configuration so as to be able to repeat the operations if necessary

7. OPERATIONS WITH THE MEMORY

Each memory location consists of 3 levels: **LEVEL1**, **LEVEL2** and **LEVEL3** whose names can be defined in the Setup menu (see § 5.5). At least LEVEL1 must be inserted the first time the **SAVE** key is pressed. It is possible to add a comment (**max 30 characters**) to each saved result. Once saved, the measurement result is automatically assigned to a memory location that is updated progressively with each operation (max 999 locations). The date / time and the operator to be defined during programming are also added to the result (see § 5.2).

7.1. SAVING DATA

In order to save the measurement result, proceed as follows:

1. Carry out the measurement
2. Press the **SAVE** hard key, the following screen is displayed (example)

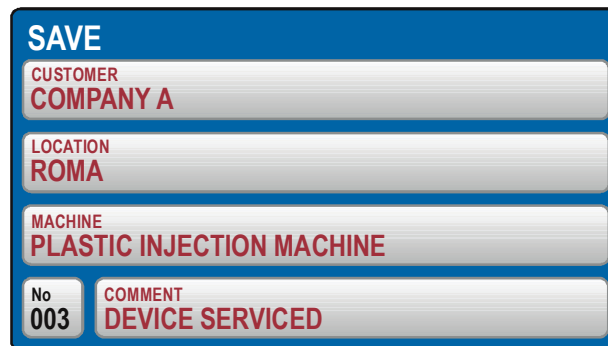

Fig. 80 : SAVE menu – Initial screen

3. Enter the information in the 3 levels and if necessary include a comment associated with the measurement
4. If you need to change and/or add the name associated with a level (e.g. LEVEL1), tap the corresponding field. The following screen appears on the display

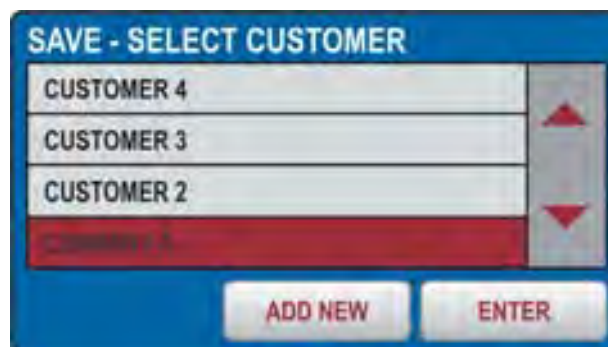

Fig. 81 : SAVE menu – Modify LEVEL1

5. Check the list of available customers by using the ▼ and ▲ touch-screen keys (if there are more than 4 customers entered)
6. Press the **ADD NEW** touch-screen key, the following screen will appear

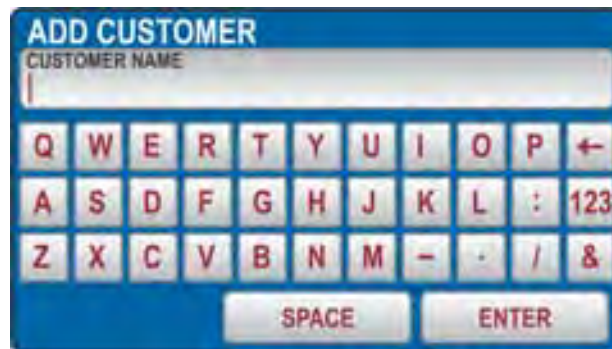

Fig. 82 : SAVE menu – Add new CUSTOMER

7. Press the **ENTER** touch-screen key to confirm the selection
8. Repeat the operation for the other two levels and for comment if needed following the same procedure

CAUTION



When selecting **LEVEL2** or **LEVEL3** already used names and “**BLANK**” are offered, so the operator can select one of existing names or **BLANK** level directly (level 2 and level 3 are not required)

9. Press the **SAVE** hard key again to confirm saving operation. An acoustic sound will follow as a confirmation save operation has successfully been accomplished. Measurement screen will be offered again

CAUTION



- **LEVEL1** it is mandatory be entered when saving test result while **LEVEL2**, **LEVEL3** and **COMMENT** are not required
- Levels shall be selected/entered in order from the top (**LEVEL1**) to the bottom (**COMMENT**). Do not skip empty levels

7.2. SAVING AN AUTOTEST

1. Carry out the selected Autotest
2. Press the **SAVE** hard key, the following screen is displayed



Fig. 83 : Saving Autotest menu – Step 1

3. It is possible in this phase to modify **only the value associated to LEVEL1** (the values associated with LEVEL2, LEVEL3 and COMMENT cannot be changed). Touch the LEVEL1 field. The screen of Fig. 84 - left side is shown on the display

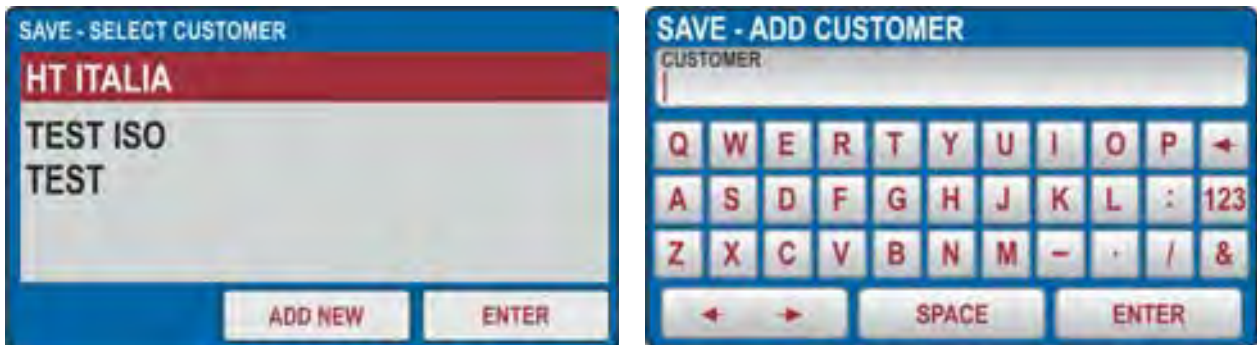

Fig. 84 : Saving Autotest menu – Modify name of LEVEL1

4. Press the virtual key **ADD NEW** to add a new reference and confirm with **ENTER**
5. Press the **SAVE** key again to confirm the operation. An acoustic signal will follow to confirm that the saving has been completed successfully



CAUTION

Possible comments on the measurements can **ONLY** be entered within the individual tests included in the Autotest

7.3. RECALL RESULTS ON THE DISPLAY

1. Press the **RCL** hard key, the following screen will appear (example).



Fig. 85 : RECALL menu

2. Check offered customer and if needed, select another one by pressing the **CUSTOMER** touch-screen key first. The following screen will appear.

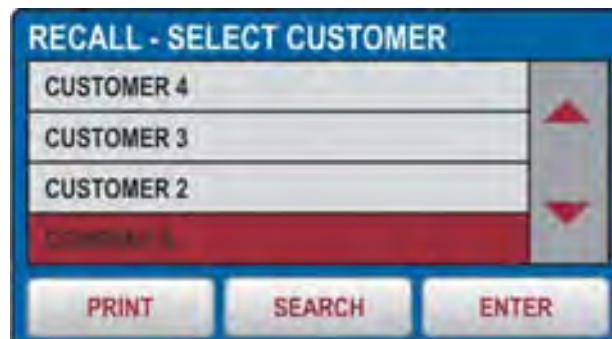

Fig. 86 : RECALL menu – Modify LEVEL1

3. Check the list of available customers by using the ▼ and ▲ touch-screen keys (if there are more than 4 customers entered)
4. Mark appropriate customer by pressing the customer touch-screen key, e.g. **CUSTOMER 3**
5. Confirm the selection by pressing the **ENTER** touch-screen key, screen will turn to RECALL menu. If there is a list of many available customers use the **SEARCH** touch-screen key to select appropriate one quickly
6. Press the **PRINT** key to print the screen (with optional **FT3MPT2** connected to the USB2 or USB3 inputs)
7. Select wished measurement by using the ▼ and ▲ keys
8. Press the **RCL** hard key again, saved result will be displayed as follows



Fig. 87 : RECALL menu – Recall result screen

9. Press the **RCL** hard key again in order to check next screens
10. Press the **EXIT** key to exit and return to the main screen

8. USE OF OPTIONAL ACCESSORIES

8.1. USE OF EXTERNAL KEYBOARD

The external USB keyboard (optional accessory **FT3KBDEN**) can be used if it is necessary to enter data in the instrument's memory (customer, machine, location and comments) in a simple and quick way.

1. Connect the USB keyboard to the **USB2** or **USB3** inputs (see Fig. 2 - part 10)
2. The instrument emits 3 acoustic signals to confirm the accessory recognition

8.2. USE OF BARCODE READER

The USB barcode reader (optional accessory **FT3BARCR**) can be used when it is necessary to insert a new customer in memory to perform the job in a simple and quick way.

1. Connect the barcode reader to the **USB2** or **USB3** inputs (see Fig. 2 - part 10)
2. The instrument emits 3 acoustic signals to confirm the accessory recognition
3. Perform the measurement
4. Press the **SAVE** hard key, the followed screen is shown:

The screenshot shows a blue-bordered screen titled "SAVE". It contains four data entry fields with red text:

- CUSTOMER:** COMPANY A
- LOCATION:** ROMA
- MACHINE:** PLASTIC INJECTION MACHINE
- COMMENT:** DEVICE SERVICED

There is also a small box on the left side of the COMMENT field containing the text "No 003".

Fig. 88 : Measure with barcode reader – Saving data

5. Press the **CUSTOMER** touch-screen key, the followed screen is shown:

The figure shows two side-by-side screenshots of the instrument's interface:

- Left screenshot:** Titled "SAVE - SELECT CUSTOMER". It displays a list of customer names: CUSTOMER 4, CUSTOMER 3, CUSTOMER 2, and COMPANY A. The "COMPANY A" entry is highlighted in red. Below the list are two buttons: "ADD NEW" and "ENTER".
- Right screenshot:** Titled "ADD CUSTOMER". It shows a text input field for "CUSTOMER NAME" with a cursor. Below the field is a full QWERTY keyboard with red characters on the keys. At the bottom are "SPACE" and "ENTER" buttons.

Fig. 89 : Measure with barcode reader – Customer selection

6. Press the **ADD NEW** soft key if you need to enter a new customer. The screen of Fig. 89 - right side is shown on the display
7. Scan the customer's label (barcode) using the USB barcode reader. The customer name will be entered and the display will return to the previous menu
8. Modify or enter the other two save levels (LOCATION and MACHINE) as well as COMMENT manually if needed, then confirm save operation by pressing the **SAVE** hard key again

8.2.1. Barcode reader configuration

When using the **Honeywell Voyager 1250G-2USB-1** barcode reader (optional accessory **FT3BARCR**) for the first time, it must be configured as follows

1. Connect the barcode reader to the instrument
2. Switch on the instrument in order to assure proper power supply.
3. Start the initial configuration of the barcode reader by scanning the code below.



4. Set the prefix of the barcode reader by scanning the code below.



5. Set the suffix of the barcode reader by scanning the code below.



6. Finish the configuration of the barcode reader by scanning the code below.



7. Switch off and on again the instrument after scanning above mentioned codes, the barcode reader and the instrument are then ready to be used



CAUTION

Use only the Barcode reader Honeywell type Voyager 1250G-2USB-1 otherwise it may not be recognized by the instrument

9. UPDATING FIRMWARE OF THE INSTRUMENT

It is possible to update the internal firmware (FW) of the instrument by using a USB pen drive. Proceed as follows:

1. Update the **TopView** management software supplied at the latest available version
2. Insert a USB drive with a **maximum size of 64GB FAT32 formatted** into the PC
3. Download the latest version of the FW from the "PC → instrument connection" section of TopView
4. Run the downloaded file "**90550_PENDRIVE_FW_UPG_setup.exe**" which will load the latest version of the FW inside the USB pen drive
5. Remove the pen drive and connect it to the instrument's **USB2** or **USB3** inputs
6. Confirm the FW update request message shown on the display
7. Wait for the instrument display to return to the home screen and remove the USB pen drive. The new FW has been installed
8. Check the installed version (see § 5.4)

10. MAINTENANCE

10.1. GENERAL

1. During use and storage, follow the recommendations listed in this manual to avoid possible damage or danger during use
2. Do not use the instrument in environments with high humidity or high temperature. Do not expose to direct sunlight. Always switch off the instrument after use

10.2. CLEANING THE INSTRUMENT

1. If the tester is needed to be cleaned after daily usage, it is advisable to use a wet cloth and a mild household detergent
2. Prior to cleaning, remove the machinery tester from all measurement circuits and from mains. Never use acid-based detergents or dissolvent liquids for cleaning. After cleaning it, do not use the instrument until it is completely dried up.

10.3. FUSE REPLACEMENT

In case of replacement of internal fuses proceed as follows:



CAUTION

- Only experienced technicians can do this. Before performing this operation, make sure you have removed all the cables from the input terminals and disconnect the instrument from the power supply
- Use only fuses complying with the instructions in the §

Replacement Fuse F1 and F2

- The F1 and F2 fuses are general mains ones for the tester and protect internal circuitry in POWER, RPE and DIELECTRIC measurements
 - In case mains switch pilot lamp (see Fig. 2 – part 5) does not illuminate after connecting the instrument to mains outlet and switching on the mains switch and neither the LC-Display shows any indication, it is very likely mains fuse **F1** (see Fig. 2 – part 4) or **F2** (see Fig. 2 – part 3) or both to be blown
1. Open the fuse holder **F1** and **F2** by using an appropriate screwdriver
 2. Remove the defective fuse and replace it with a new one (see §)
 3. Replace the fuse holder

Replacement Fuse F3

- The F3 fuse protect internal circuitry in LOOP, RA or RCD function
 - The fuse F3 is damaged if the message "F3 FUSE" appears on the display in the LOOP, RA or RCD functions
1. Open the fuse holder **F3** (see Fig. 2 – part 2) by using an appropriate screwdriver
 2. Remove the defective fuse and replace it with a new one (see §)
 3. Replace the fuse holder.

Replacement Fuse F4

- The fuse F4 is damaged if the message "F4 FUSE" appears on the display in the RPE function
1. Open the fuse holder **F4** (see Fig. 2 – part 15) by using an appropriate screwdriver
 2. Remove the defective fuse and replace it with a new one (see §)
 3. Replace the fuse holder.



CAUTION

If any fuse blows several times (for example in case of operating error) the instrument must be sent in to the service department

10.4. END OF LIFE



CAUTION: this symbol indicates that the equipment and its accessories must be collected separately and disposed of in the right way.

TECHNICAL SPECIFICATIONS

10.5. TECHNICAL CHARACTERISTICS

Accuracy calculated as $\pm[\% \text{reading} + (\text{num.dgt} * \text{resolution})]$ at $23^{\circ}\text{C} \pm 5^{\circ}\text{C}$, $<60\% \text{RH}$

CONTINUITY OF PE CONDUCTOR (RPE-2WIRE, 200mA)			
Range [Ω]	Resolution [Ω]	Accuracy	Overload protection
0.00 ÷ 19.99	0.01	$\pm (3\% \text{rdg} + 3 \text{dgt})$	CAT III 300 V
20.0 ÷ 200.0	0.1		
Open-circuit test voltage:	approx. 4.5VAC		
Short-circuit test current:	<0.6A (standard test leads)		
Test current:	>200mA (standard test leads and external resistance < 20 Ω)		
Range of test current:	10mA ÷ 255mA		
Accuracy of test current:	$\pm(3\% \text{rdg.} + 2 \text{dgt})$		
Limit value:	0.01 Ω ÷ 200.0 Ω adjustable		
Timer on measurement:	2s ÷ 60min programmable		
Measurement principle:	2-Wire connection		
Test lead calibration:	up to 5.00 Ω		
Protection:	Fuse F4		
Detection of external voltage	UEXT lim = 3VAC (between two RPE or between two SENSE terminals) UEXT lim = 10VAC (between two RPE or between two SENSE terminals) UEXT lim = 30VAC approx. (between any RPE/SENSE terminal and GND)		

CONTINUITY OF PE CONDUCTOR (RPE-2WIRE, 25A)			
Range [Ω]	Resolution [Ω]	Accuracy	Overload protection
0.000 ÷ 1.999	0.001	$\pm (3\% \text{rdg.} + 3 \text{dgt})$	CAT III 300 V
2.00 ÷ 20.00	0.01		
Open-circuit test voltage:	approx. 4.5VAC		
Short-circuit test current:	<30A (standard test leads)		
Test current (25A range):	> 25A (standard test leads and external resistance < 0.1Ω) >10A (standard test leads and external resistance < 0.5Ω)		
Range of test current:	0.2A ÷ 30.0A		
Accuracy of test current:	$\pm (3\% \text{rdg.} + 1 \text{dgt})$		
Limit value:	0.01 Ω ÷ 20.00 Ω adjustable OR calculation through loop impedance OR calculation through wire length		
Timer on measurement:	2s ÷ 60min programmable (test current > 10A) 2s ÷ 5min programmable (test current > 25A)		
Measurement principle:	Two-wire connection		
Test lead calibration:	Up to 5.00 Ω		
Protection:	Fuse F4		
Detection of external voltage	Yes (see RPE-2WIRE, 200mA)		

CONTINUITY OF PE CONDUCTOR (RPE-4WIRE, 25A)			
Range [Ω]	Resolution [Ω]	Accuracy	Overload protection
0.000 ÷ 1.999	0.001	$\pm (3\% \text{rdg.} + 3 \text{dgt})$	CAT III 300 V
2.00 ÷ 20.00	0.01		
Open-circuit test voltage:	approx. 4.5VAC		
Short-circuit test current:	<30A (standard test leads)		
Test current (25A range):	>25A (standard test leads and external resistance < 0.1Ω) >10A (standard test leads and external resistance < 0.5Ω)		
Range of test current:	0.2A ÷ 30.0A		
Accuracy of test current:	$\pm (3\% \text{rdg.} + 1 \text{dgt})$		
Limit value:	(see RPE-2WIRE 25A)		
Timer on measurement:	2s ÷ 5min programmable		
Measurement principle:	4-Wire connection		
Protection:	Fuse F4		
Detection of external voltage	automatically detected Yes (see RPE-2WIRE, 200mA)		

INSULATION RESISTANCE (MΩ)				
DC Test voltage [V]	Range [MΩ]	Resolution [MΩ]	Accuracy	Overload protection
100	0.00 ÷ 9.99	0.01	± (3%rdg + 3dgt)	CAT III 300 V
	10.0 ÷ 20.0	0.1		
	20.0 ÷ 99.9		± 5%rdg	
250	0.00 ÷ 9.99	0.01	± (3%rdg + 3dgt)	
	10.0 ÷ 20.0	0.1	± 5%rdg	
	20.0 ÷ 99.9			
	100 ÷ 250	1		
500	0.00 ÷ 9.99	0.01	± (3%rdg + 3dgt)	
	10.0 ÷ 20.0	0.1	± 5%rdg	
	20.0 ÷ 99.9			
	100 ÷ 500	1		
1000	0.00 ÷ 9.99	0.01	± (3%rdg + 3dgt)	
	10.0 ÷ 20.0	0.1	± 5%rdg	
	20.0 ÷ 99.9			
	100 ÷ 1000	1		

Test voltage accuracy: (-0% ÷ +25%) of U_n
 Test current: >1mA (up to $U_n/1mA$)
 Short-circuit current: < 15mA
 Discharging object on test: Internal resistance of 2MΩ after finishing measurement
 Detection of external voltage: UEXT lim = 10VAC (between RISO+ and RISO- terminals)
 UEXT lim = 50 VAC (between RISO+ and RISO- terminals)
 UEXT lim = 50VAC approx. (between any RISO terminal and GND)
 UEXT lim = -10VDC (between RISO+ and RISO- terminals)

DIELECTRIC WITHSTANDING TEST (DIELECTRIC)			
Nominal test voltage U_N [V]	Resolution (V)	Accuracy	Overload protection
250 ÷ 800	10	±3% U_N	CAT III 300 V
810 ÷ 2500			
2510 ÷ 5100			

Nominal test voltage U_N : Adjustable 250 ÷ 5100 V, 50/60 Hz in steps of 10V
 Distortion of test voltage: Crest factor CF = 1.414 ± 5%
 Measurement modes: MANUAL, RAMP (timer), BURN or PULSE (duration of 3 measurement cycles:: 60ms@50Hz, 50ms@60Hz)
 Output power: 500VA (@ 5100V)

Discharging current IAPP

Range [mA]	Resolution [mA]	Accuracy
0 ÷ 200	1	±(3%rdg + 2mA)

Discharging current IREAL

Range [mA]	Resolution [mA]	Accuracy
0 ÷ 110	1	± (3%rdg + 4mA)

Nominal breaking current (IAPP or IREAL): Adjustable 1 ÷ 110 mA in steps of 1mA
 Short-circuit current: >200mA
 Breaking time: <30ms

RCD TEST (RCD)

RCD types / characteristics:	AC, A or B / General, Selective or Delayed
Measurement modes:	$\frac{1}{2} I_{\Delta N}$, $I_{\Delta N}$, $2I_{\Delta N}$, $KI_{\Delta N}$ (K = 4 B type, K=5 AC, A type) I_{Δ} (RAMP), AUTO (sequence: $x\frac{1}{2}$, $x1$, xK)
Nominal currents:	10, 30, 100, 300, 500, 650 or 1000 Ma
Delayed time range:	0ms ÷ 700ms adjustable
Accuracy of test currents (10 mA):	-10% / + 0% ($I_{\Delta N}/2$), +10% / - 0% ($I_{\Delta N}$, $2I_{\Delta N}$, $KI_{\Delta N}$)
Accuracy of test currents (30÷1000 mA):	-5% / + 0% ($I_{\Delta N}/2$), + 5% / - 0% ($I_{\Delta N}$, $2I_{\Delta N}$, $KI_{\Delta N}$)
Input voltage range / frequency:	100 V ÷ 265V / (50/60Hz) ± 0.5Hz
Contact voltage limits:	25 V or 50 V selectable
Test current polarity:	0° (Positive) o 180° (Negative)

Test duration [ms] – TT/TN system

$I_{\Delta N}$ [mA]		$x\frac{1}{2}$	$x1$	$x2$			xK			AUTO			RAMP		
		G, S, D	G, S, D	G	S	D	G	S	D	G	S	D	G	S	D
10 30 100	AC	1000	1000	200	250	X	50	150	X	✓	✓	X	320	X	X
	A	1000	1000	200	250	X	50	150	X	✓	✓	X	320	X	X
	B	1000	1000	X	X	X	200	250	X	✓	✓	X	320	X	X
300	AC	1000	1000	200	250	X	50	150	X	✓	✓	X	320	X	X
	A	1000	1000	200	250	X	50	150	X	✓	✓	X	320	X	X
	B	1000	1000	X	X	X	X	X	X	X	X	X	320	X	X
500	AC	1000	1000	200	250	X	50	150	X	✓	✓	X	320	X	X
	A	1000	1000	200	250	X	X	X	X	X	X	X	320	X	X
	B	1000	1000	X	X	X	X	X	X	X	X	X	320	X	X
650	AC	1000	1000	200	250	X	50	150	X	✓	✓	X	320	X	X
	A	1000	1000	200	250	X	X	X	X	X	X	X	320	X	X
	B	X	X	X	X	X	X	X	X	X	X	X	X	X	X
1000	AC	1000	1000	200	250	X	X	X	X	X	X	X	320	X	X
	A	1000	1000	X	X	X	X	X	X	X	X	X	X	X	X
	B	X	X	X	X	X	X	X	X	X	X	X	X	X	X

Resolution: 1ms, Accuracy: ± 3%rdg + 2ms)

X = test not possible

Mains voltage UL/N, UL/PE

Range [V]	Resolution [V]	Accuracy
100 ÷ 265	1	± (3%rdg)

Input resistance (UL/N, UL/PE):

450 kΩ

Ramp test:

 current range 10% ÷ 110% of $I_{\Delta N}$ in steps of 5% of $I_{\Delta N}$

AUTO TEST:

 test steps are as follows: $t/I_{\Delta N}/2$ (0°), $t/I_{\Delta N}/2$ (180°), $t/I_{\Delta N}$ (0°), $t/I_{\Delta N}$ (180°), $t/5I_{\Delta N}$ (0°), $t/5I_{\Delta N}$ (180°)

LOOP IMPEDANCE / SHORT-CIRCUIT CURRENT (LOOP)

Range [Ω]	Resolution [Ω]	Accuracy	Overload protection
0.000 ÷ 2.000 (*)	0.001	\pm (3%rdg + 3dgt)	CAT III 300 V
0.00 ÷ 9.99	0.01		
10.0 ÷ 99.9	0.1		
100 ÷ 200	1		

(*) With optional accessory IMP57

Input voltage range LOOP L/PE or L/N:

100V ÷ 265V, 50/60Hz

Input voltage range LOOP L/L:

100 ÷ 460V, 50/60 Hz

Nominal mains voltage:

110V, 115V, 120V, 133V, 220V, 230V, 240V

Loading resistance:

10 Ω for 20ms (range 0.00 ÷ 30.0 Ω) and

180 Ω for 20ms (range 30.0 ÷ 200.0 Ω)

Short-circuit current (ISC)

Range [A]	Resolution [A]	Accuracy
0.05 ÷ 0.99	0.01	Depends on UL/PE and Z accuracy
1.0 ÷ 99.9	0.1	
100 ÷ 999	1	
1.00k ÷ 46.00k	10	

Mains voltage UL/N, UL/PE

Range [V]	Resolution [V]	Accuracy
100 ÷ 265	1	\pm (3%rdg)

Input resistance (UL/N, UL/PE): 450k Ω

Mains voltage UL/L

Range [V]	Resolution [V]	Accuracy
100 ÷ 460	1	\pm (3%rdg)

Input resistance (UL/N, UL/PE): 450k Ω

GLOBAL EARTH RESISTANCE WITHOUT TRIPPING RCD (RA)

$I_{\Delta N}$ [mA]	Range [Ω]	Resolution [Ω]	Accuracy (*)	Overload protection
10	0 ÷ 2000	1	$\pm (3\%rdg + 1\Omega)$	CAT III 300 V
30	0.0 ÷ 99.9	0.1		
	100 ÷ 2000	1		
100	0.0 ÷ 99.9	0.1	$\pm (3\%rdg. + 3dgt)$	
	100 ÷ 1000	1		
300	0.0 ÷ 99.9	0.1		
	100 ÷ 300	1		
500	0.0 ÷ 99.9	0.1		
	100 ÷ 200	1		
650	0.0 ÷ 99.9	0.1		
	100 ÷ 150	1		
1000	0.0 ÷ 100.0	0.1		

(*) The accuracy in the $10\Omega \div 2000\Omega$ range may be affected by instable mains voltage

Test current:

$I_{\Delta N} / 2$

Input voltage range:

100 ÷ 265 V, 50/60 Hz

Nominal mains voltage :

110V, 115V, 120V, 133V, 220V, 230V, 240V

Mains voltage UL/PE

Range [V]	Resolution [V]	Accuracy
100 ÷ 265	1	$\pm (3\%rdg)$

Input resistance (UL/PE):

450 k Ω

Contact voltage UC at $I_{\Delta N}$

Range [V]	Resolution [V]	Accuracy
0 ÷ 100 (UC LIM = 50 V)	1	$\pm (3\%rdg. + 3V)$
0 ÷ 50 (UC LIM = 25 V)		

TRMS RESIDUAL VOLTAGE (URES)

Range [V]	Resolution [V]	Accuracy	Overload protection
10 ÷ 460 (AC)	1	$\pm (3\%rdg. + 3V)$	CAT III 300V
10 ÷ 650 (DC)			

Input voltage (UTRIG):

0V ÷ 460 VAC

Nominal mains voltage :

110V, 115V, 120V, 133V, 220V, 230V, 240V

Measurement method:

4-wire connection (INTERNAL measurement, 1s or 5s)

2-wire connection (PLUG measurement, 1 s)

Residual voltage limit value:

60V RMS

Input voltage URES:

Range [V]	Resolution [V]	Accuracy
10 ÷ 460 (AC)	1	$\pm (2\%rdg + 2V)$
10 ÷ 650 (DC)		

Input resistance (URES):

100 M Ω

Input voltage UTRIG:

Range [V]	Resolution [V]	Accuracy
10 ÷ 265 (AC)	1	$\pm (2\%rdg. + 2V)$

Input resistance (UTRIG):

450 k Ω

FUNCTIONAL TEST – TRMS LOAD CURRENT ON SOCKET

Range [A]	Resolution [A]	Accuracy	Overload protection
0.00 ÷ 0.99	0.01	± (3%rdg. + 3dgt)	CAT II 300 V
1.0 ÷ 20.0	0.1		

Frequency range:

15Hz ÷ 723Hz

Protection:

automatic interruption 10s after exceeding 16A

Pre-Test

Grounding of PE terminal on schuko socket

FUNCTIONAL TEST – TRMS MAINS VOLTAGE ON SOCKET

Range [V]	Resolution [V]	Accuracy	Overload protection
195 ÷ 253	1	± (2%rdg + 2dgt)	CAT II 300 V

Frequency range

15Hz ÷ 723Hz

FUNCTIONAL TEST – APPARENT POWER / ACTIVE POWER ON SOCKET

Range [VA/W]	Resolution [VA/W]	Accuracy	Overload protection
0.0 ÷ 99.9	0.1	±(5%rdg. + 10dgt)	CAT II 300 V
100 ÷ 999	1	± (5%rdg. + 3dgt)	
1.00 ÷ 5.06 k	10		

Limit value PAPP

Adjustable 6 ÷ 999VA, 1.00kVA ÷ 5.06kVA

FUNCTIONAL TEST – POWER FACTOR ON SOCKET

Range	Resolution	Accuracy	Overload protection
0.00 ÷ 1.00	0.01	Depend on PAPP and PACT	CAT II 300 V

FUNCTIONAL TEST – TRMS LEAKAGE CURRENT ON SOCKET

Range	Resolution	Accuracy	Overload protection
0.25 ÷ 19.99mA	0.01mA	± (3%rdg. + 3dgt)	CAT II 300 V
20.0 ÷ 49.9mA	0.1mA		
0.05 ÷ 0.99A	0.01A		
1.0 ÷ 10.0A	0.1A		

Load current influence

± 0.01 mA/A

Limit value:

0.25mA ÷ 10.00A (standard limit value 3.50mA)

Frequency range

40Hz ÷ 723Hz (characteristics according to IEC 61557-13)

Measurement method

Differential current

Mains cord polarity exchange

yes

UUT mains on switch test

yes (limit value 25mA)

Over-range limit (IPE)

yes (measurement interrupted after 10s after exceeding 10A)

Over-range limit (IL)

yes (measurement interrupted after 10s after exceeding 16A)

PHASE SEQUENCE (PHASESEQ)

Range [V]	Resolution [V]	Accuracy	Overload protection
360 ÷ 460	1	±(2%rdg + 2dgt)	CAT III 300 V

Display of test result:

1.2.3 (correct) or 2.1.3 (incorrect) or 1.1.X (not defined)

TRMS CLAMP CURRENT WITH TRANSDUCER CLAMP HT96U (ICLAMP)

Range	Display range	Resolution	Accuracy (*)	Overload protection
1000mA	0.0 ÷ 99.9mA	0.1mA	±(3%rdg + 3dgt)	One measurement terminal grounded
	100 ÷ 1000mA	1mA		
100.0A	0.00 ÷ 9.99A	0.01A		
	10.0 ÷ 100.0A	0.1A		
1000A	0.0 ÷ 99.9A	0.1A		
	100 ÷ 1000A	1A		

(*) Accuracy of only instrument without clamp

Input voltage range: 0V ÷ 1VAC
 Input resistance: 1MΩ
 Frequency range: 40Hz ÷ 723 Hz (characteristics according to IEC 61557-13)
 Clamp type: HT96U (measuring ranges 1 A, 100A, 1000A)
 LIM value (1000mA range): Adjustable 0.1 ÷ 99.9mA, 100 ÷ 1000mA
 LIM value (100.0A range): Adjustable 0.1 ÷ 100.0A
 LIM value (1000A range): Adjustable 1 ÷ 1000A

TRMS LEAKAGE CURRENT WITH TRANSDUCER CLAMP HT96U (ILEAK)

Range	Display range	Resolution	Accuracy (*)	Overload protection
1000mA	0.0 ÷ 99.9mA	0.1mA	±(3%rdg + 3dgt)	One measurement terminal grounded
	100 ÷ 1000mA	1mA		
100.0A	0.00 ÷ 9.99A	0.01A		
	10.0 ÷ 100.0A	0.1A		
1000A	0.0 ÷ 99.9A	0.1A		
	100 ÷ 1000A	1A		

(*) Accuracy of only instrument without clamp

Input voltage range: 0V ÷ 1VAC
 Input resistance: 1MΩ
 Frequency range: 40Hz ÷ 723 Hz (characteristics according to IEC 61557-13)
 Clamp type: HT96U (measuring ranges 1 A, 100A, 1000A)
 LIM value (1000mA range): Adjustable 0.1 ÷ 99.9mA, 100 ÷ 1000mA
 LIM value (100.0A range): Adjustable 0.1 ÷ 100.0A
 LIM value (1000A range): Adjustable 1 ÷ 1000A

TRMS LEAKAGE CURRENT ON TEST SOCKET (ILEAK)

Range	Resolution	Accuracy	Overload protection
0.25 ÷ 49.99mA	0.01 mA	± (3% rdg. + 3 dgt)	CAT II 300 V
0.05 ÷ 0.99A	0.01 A		
1.0 ÷ 10.0A	0.1 A		

Load current influence: ± 0.01 mA/A
 Limit value: 0.25mA ÷ 10.00A (standard limit value 3.50mA)
 Frequency range: 40Hz ÷ 723Hz (characteristics according to IEC 61557-13)
 Measurement method: Differential current
 Mains cord polarity exchange: yes
 UUT mains on switch test: yes (limit value 25mA)
 Over-range limit (IPE): yes (measurement interrupted after 10s after exceeding 10A)
 Over-range limit (IL): yes (measurement interrupted after 10s after exceeding 16A)

10.6. GENERAL SPECIFICATION

POWER SUPPLY

Mains supply voltage:	207V ÷ 253V / 50/60Hz ± 5%
Current consumption:	16 Amax

MECHANICAL SPECIFICATIONS

Dimensions (L x W x H):	400 x 300 x 170 mm ; (16 x 12 x 7in)
Weight:	15kg (31lv)
Mechanical protection:	IP40

MEMORY AND INPUT/OUTPUT INTERFACES

Internal memory:	999 locations (3 levels memory structure)
PC interface:	USB 2.0 device, connector type "B"
USB keyboard, USB printer	2 x USB 2.0 host, connector type "A"
USB barcode reader, pen drive	2 x USB 2.0 host, connector type "A"
Pen drive requirements:	FAT32 with a sector size of 64GB
Warning lamp:	For dielectric test
Keyboard for remote controls	
START/STOP/SAVE keys:	Yes
Bluetooth interface connection:	Yes

PROTECTION FUSES

F1 Fuse:	type T16A/250V, 5x20mm, 1.5kA
F2 Fuse:	type T16A/250V, 5x20mm, 1.5kA
F3 Fuse:	type FF12.5A/500V, 6.3x32mm, 1.5kA
F4 Fuse:	type T20A/500V, 6.3x32mm, 1.5kA

ENVIRONMENTAL CONDITIONS

Reference temperature:	23°C ± 5°C (73°F ± 41°F)
Working temperature:	0° ÷ 40°C (32°F ÷ 104°F)
Reference humidity:	<60% RH w/o condensation
Working humidity:	<80% RH w/o condensation
Storage temperature:	-10 ÷ 60°C (14°F ÷ 140°F)
Storage humidity:	<80% RH w/o condensation

REFERENCE GUIDELINES

Instrument safety:	IEC/EN61010-1
EMC:	IEC/EN61326-1
Safety tests:	IEC/EN60204-1; IEC/EN61439-1; IEC/EN60335-1
Technical literature:	IEC/EN61187
Instrument:	IEC/EN61557-1-2-3-4-6-13-14
Safety dielectric test :	EN50191

GENERAL CHARACTERISTICS

Display:	4.3 inch colour TFT LCD with touch screen,
Limit value setting:	See each function separately
Warning	in case of exceeded limit values: optic and acoustic
Insulation:	Protection class I (protection conductor)
Pollution degree:	2
Measurement category:	CAT II 300V (Power), CAT III 300V (other tests)
Altitude above sea level:	2000m (6562ft)

This instrument complies with requirements of Low Voltage Directive 2014/35/EU (LVD) and of EMC Directive 2014/30/EU
This instrument complies with requirements of European Directive 2011/65/EU (RoHS) and 2012/19/EU (WEEE)

10.7. ACCESSORIES

Please see enclosed packing list

11. SERVICE

11.1. WARRANTY CONDITIONS

This instrument is guaranteed against material or production defects, in accordance with our general sales conditions. During the warranty period the manufacturer reserves the right to decide either to repair or replace the product. Should you need for any reason to return back the instrument for repair or replacement take prior agreements with the local distributor from whom you bought it. Do not forget to enclose a report describing the reasons for returning (detected fault). Use only original packaging. Any damage occurred in transit due to not original packaging will be charged anyhow to the customer. The manufacturer will not be responsible for any damage to persons or things. Accessories (not covered by warranty).

The warranty does not apply to:

- Repairs made necessary by improper use (including adaptation to particular applications not foreseen in the instructions manual) or improper combination with incompatible accessories or equipment.
- Repairs made necessary by improper shipping material causing damages in transit.
- Repairs made necessary by previous attempts for repair carried out by non skilled or unauthorized personnel.
- Instruments for whatever reason modified by the customer himself without explicit authorization of our Technical Dept.
- The contents of this manual may not be reproduced in any form whatsoever without the manufacturer's authorization.

Our products are patented and our logotypes registered. We reserve the right to modify specifications and prices in view of technological improvements or developments which might be necessary.

11.2. AFTER-SALE SERVICE

Shouldn't the instrument work properly, before contacting your distributor make sure that batteries are correctly installed and working, check the test leads and replace them if necessary. Make sure that your operating procedure corresponds to the one described in this manual. Should you need for any reason to return back the instrument for repair or replacement take prior agreements with the local distributor from whom you bought it. Do not forget to enclose a report describing the reasons for returning (detected fault). Use only original packaging. Any damage occurred in transit due to not original packaging will be charged anyhow to the customer. The manufacturer will not be responsible for any damage to persons or things.



HT INSTRUMENTS SA

C/ Legalitat, 89
08024 Barcelona - **ESP**
Tel.: +34 93 408 17 77, Fax: +34 93 408 36 30
eMail: info@htinstruments.com
eMail: info@htinstruments.es
Web: www.htinstruments.es

HT INSTRUMENTS USA LLC

3145 Bordentown Avenue W3
08859 Parlin - NJ - **USA**
Tel: +1 719 421 9323
eMail: sales@ht-instruments.us
Web: www.ht-instruments.com

HT ITALIA SRL

Via della Boaria, 40
48018 Faenza (RA) - **ITA**
Tel: +39 0546 621002
Fax: +39 0546 621144
eMail: ht@htitalia.it
Web: www.ht-instruments.com

HT INSTRUMENTS GMBH

Am Waldfriedhof 1b
D-41352 Korschenbroich - **GER**
Tel: +49 (0) 2161 564 581
Fax: + 49 (0) 2161 564 583
eMail: info@ht-instruments.de
Web: www.ht-instruments.de

HT INSTRUMENTS BRASIL

Rua Aguçu, 171, bl. Ipê, sala 108
13098321 Campinas SP - **BRA**
Tel: +55 19 3367.8775
Fax: +55 19 9979.11325
eMail: vendas@ht-instruments.com.br
Web: www.ht-instruments.com.br

HT ITALIA CHINA OFFICE

意大利HT中国办事处
Room 3208, 490# Tianhe road, Guangzhou - **CHN**
地址 : 广州市天河路490号壬丰大厦3208室
Tel.: +86 400-882-1983, Fax: +86 (0) 20-38023992
eMail: zenglx_73@hotmail.com
Web: www.guangzhouht.com